

The Wireless World

AND RADIO REVIEW

The Paper for Every Wireless Amateur

4^D

Wednesday, June 4th, 1930.

**No Batteries
No Accumulators
Plug-in - That's all!**

Write for Free Booklet
on "All-Electric Radio"
and details of Easy Pay-
ments to E. K. Cole Ltd.,
Dept. W, "Ekco" Works,
Leigh-on-Sea.

Ekco

EKCO-LECTRIC RADIO RECEIVERS



**FIRST-
BECAUSE OF
THE FILAMENT**

Mullard
THE MASTER VALVE

**Condenser ruptured—
Great expense—
HYDRA next time—
Eighteen pence!**

**LOUIS HOLZMAN, 37, NEWMAN ST., LONDON,
W.1. Telephone: Museum 264Z.**

STILL ON TOP!



Blue Spot

**BLUE
SPOT
66K
UNIT**

25/-



The family favourite

THE fall in the value of metals and raw materials, and increased production, enables us to reduce prices.



ARE DOWN IN PRICE

WINNER SERIES

60 VOLTS ~~8/~~ 6/6

66 VOLTS ~~7/6~~ 7/

99 VOLTS ~~11/6~~ 10/9

120 VOLTS ~~14/~~ 13/

Obtainable Everywhere

These reductions give value second to none, for two-valve sets requiring 6 m.a. emission. Ask for an EVER READY next time if you require 100% service at minimum cost.

The Ever Ready Co. (G.B.) Ltd.,
Hercules Place, Holloway, London, N.7.

Mention of "The Wireless World." when writing to advertisers, will ensure prompt attention.

256A

THE "PAPER"

PERFORMANCE THAT IS PRACTICAL



Here's a valve that does what it's meant to do. Here's a valve that can successfully handle big signal voltages without danger of distortion—a valve suitable for operating speakers of the moving coil type. This new Mullard Power Valve offers an opportunity for further advancement in the field of speaker reproduction.

- Filament Voltage* - - - 6 volts
- Filament Current* - - - 0.25 amp.
- Maximum Anode Voltage* - 200 volts
- *Anode Impedance* - - - 1,400 ohms
- *Amplification Factor* - - 3.6
- *Mutual Conductance* - - 2.6 mA/volt
- *At Anode Volts 100; Grid Volts zero*

P.M.
256A
PRICE
15/-

POWER VALVE



Advt. The Mullard Wireless Service Co., Ltd., Mullard House, Charing Cross Rd., W.C.2.

Advertisements for "The Wireless World" are only accepted from firms we believe to be thoroughly reliable.

Arks



Lewcos "X" Coil.
Patent 271,384.
60X, 75X, 4/9 each.
200X, 250X, 300X,
8/8 each.

For
consistency of
performance—

LEWCOS
REGD.

RADIO PRODUCTS

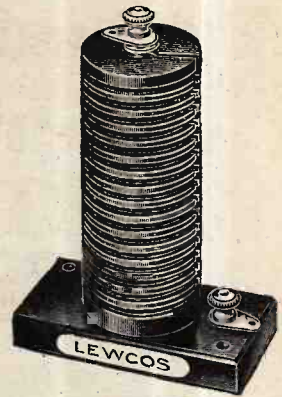

Lewcos H.F. Choke.
Price 7/9

cannot be surpassed. Technical experts and experienced users alike recommend Lewcos Radio Components for their supreme reliability in receivers of all descriptions. Lewcos "X" Coils have now firmly established themselves as a necessity with discriminating users of Radio Sets. Supplied with Continental two-pin fitting. The Lewcos H.F. Choke provides an absolutely efficient performance on all wavelengths from 2,000 down to 20 metres.



GLAZITE
BRITISH MADE REGD.

Coloured Connecting
Wire in soft Coils.
Price 6d. per coil.

The LONDON ELECTRIC WIRE COMPANY
AND SMITHS LIMITED,
Church Road, Leyton, E.10.

Stocks held at: Belfast, Cardiff, Dublin, Glasgow, Leeds, Liverpool,
London, Manchester and Newcastle.



D·C to A·C

If your supply mains are D.C. you
can operate an A.C. All-Electric
Receiver by using the



D. C. to A. C.
**ROTARY
TRANSFORMER**

Can be supplied to run from any voltage
12-250 V.D.C. 40 watt model £13; 85
watt model £19. Recommended and used
by Philips Radio, Marconiphone, Burndep't,
Kolster-Brandes, M.P.A., Etc., Etc.

Write for Pamphlet 596/1 which gives full details

THE M-L MAGNETO SYND. LTD.,
Radio Dept., COVENTRY.

Telephone: 5001.



Mention of "The Wireless World," when writing to advertisers, will ensure prompt attention.

A good set deserves EDISWAN batteries



A good set works better with Ediswan batteries, giving stronger and clearer results free from unpleasant crackling. Ediswan batteries give faithful service, too, and will "stand up to it" long after another battery would have been discarded.

Super quality only—obtainable from all high-class Wireless dealers.

Ask for

EDISWAN DRY BATTERIES



THE EDISON SWAN ELECTRIC CO., LTD.,
123/5, QUEEN VICTORIA STREET, LONDON, E.C.4.
Showrooms in all the Principal Towns.

B.69

INTRODUCING TYPE 1821



Philips make rectifying valves for every purpose for voltages up to 4,000 and currents up to 40 amps. There is a Philips valve suitable for every all-electric receiver, H.T. unit, transmitter, amplifier, etc.

The new Philips rectifying valve is a full-wave rectifier with a maximum anode voltage of 250 and gives an output of 60 m/A. The filament takes a current of 1 amp. at 4 volts.

PRICE 17/6

Write for full particulars

PHILIPS RECTIFYING VALVES

Made by the manufacturers of the famous Philips Argenta electric lamps, commercial and industrial fittings, all-electric radio receivers, and neon signs.

PHILIPS LAMPS LTD., PHILIPS HOUSE, 145, CHARING CROSS ROAD,
LONDON, W.C.2.

R.V.5.

**ENORMOUS
MAGNIFICATION
ABSOLUTE
STABILITY AND
EXCEPTIONAL
SENSITIVITY!**

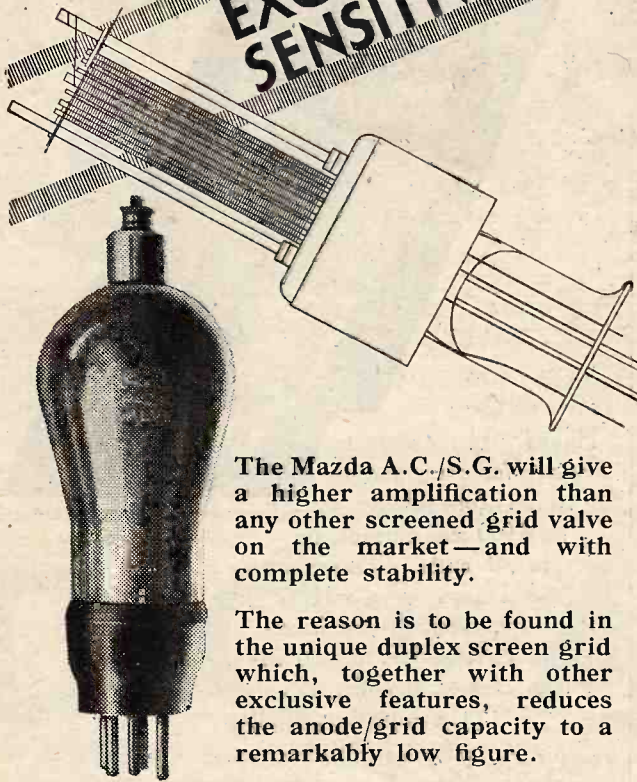

The Mazda A.C./S.G. will give a higher amplification than any other screened grid valve on the market—and with complete stability.

The reason is to be found in the unique duplex screen grid which, together with other exclusive features, reduces the anode/grid capacity to a remarkably low figure.

The Amazing

MAZDA **PRICE 25/-**
RADIO VALVES



THE EDISON SWAN ELECTRIC CO., LTD.,
Radio Division,
1a, Newman Street, Oxford Street, W.1.
Showrooms in all the Principal Towns.

EDISWAN V.37

Mention of "The Wireless World," when writing to advertisers, will ensure prompt attention.

THE CELESTION

TILTATONE

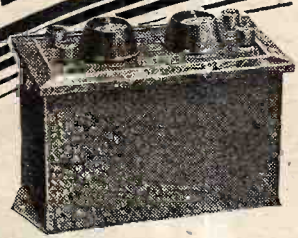

The Greatest Modern Contribution to the World of Gramophone Music

**AMPLIFIES
CORRECTS
CONTROLS**

An instrument which allows the output curve of an Electrical Gramophone to be varied by merely turning a single control, and volume to be regulated without cutting the higher frequencies. Middle frequencies included or subdued without affecting really high or low. Incorporates two exclusive features never before within reach of the radio public.

Write for full details now:
CELESTION Ltd.
Kingston-on-Thames.

LONDON
SHOWROOMS:
106, Victoria Street,
S.W.1.

CELESTION
The Very Soul of Music

299

PARFAIT
THE PERFECT
EBONITE PANEL
ONE QUALITY ONLY
— THE BEST —

SUPPLIED IN SIX FINISHES | Matt Cube Surface | Semi-Polished Mahogany | Highly Polished Black | Highly Polished Mahogany | Semi-Polished Black
Stocked by most Wireless dealers. If any difficulty in obtaining locally write for name of nearest stockist to:
H. B. POTTER & Co., Ltd., Station Buildings, ROCHDALE.

DICTIONARY
of WIRELESS
TECHNICAL TERMS
(1926)

Compiled by S. O. Pearson, B.Sc.

Issued in conjunction with "THE WIRELESS WORLD."

THIS volume contains concise definitions of terms and expressions commonly used in wireless telephony and telegraphy, and serves as a guide to all those interested in wireless who come across, from time to time, unfamiliar words in their reading. Well illustrated and cross-referenced.

Price 2/- net. By post 2/2.

From leading booksellers or direct from

ILIFFE & SONS LTD.,

v.w.43. Dorset House, Tudor Street, London, E.C.4.



FOR THE SET THAT NEEDS A LOT

Give your set the impetus of this lusty Exide Battery, most lavish in current, most steady in service. It is behind all the big talkie and public address equipments. Where much is expected of a battery, it is this Exide that is used. It gives the most, gives it with all the will in the world.

Exide

BATTERIES FOR WIRELESS

Obtainable from Exide Service Stations and all reputable dealers. Exide Service Stations give service on every make of battery.

The "C" Series for low tension in celluloid containers
 Prices per 2 volt cell
 Type CZ 2
 20 amp. hrs. 9/6
 Type CZ 4
 40 amp. hrs. 13/6
 Type CZ 6
 60 amp. hrs. 17/6
 Other sizes up to 120 amp. hrs.

Exide Batteries, Clifton Junction, near Manchester. Branches at London, Manchester, Birmingham, Bristol and Glasgow

K 6a

Sale of Contents of a £1,000 Research Laboratory

ELECTRADIX RADIOS OFFER the contents of a Research Laboratory equipped at a cost of over £1,000 for electrical and radio work. Most of the apparatus is in new and spotless condition and would provide a first-class outfit for the Laboratory of a Technical College or an enterprising manufacturer.

A few of the items are enumerated.

A HIGH SPEED RECORDING McLACHLAN equipment by Marconi and Sullivan which can record at four times the highest speed of any commercial system in use. Complete in every detail and brand new. Cost £350.

10-RANGE SUB-STANDARDS by Nalder, Crompton, Evershed, etc., Moving Coil Sets covering all ranges in volts and amps to 600. There are 12 in all. Cost £25. Sub-divided Standard ohms to '05.

METERS, THERMO. Weston, Paul & Turner, Thermo-Meters moving-coil, 100 m/a to 10 amps. Hot-wire meters to 100 amps. Mather Electrostatic 0-150 v., Kelvin 500 v. to 2,500 v. and 1,000 v. to 5,000 volts. Moullin Voltmeter to 5 volts. A.C. 5 to 500 v. Wattmeter with current-transformers. Periodicity-meters 50, 100, 250 and 500 cycles by Weston & J.P. Also a number of D.C. panel meter.

HEAVISIDE & CAMPBELL BRIDGES for Inductance, Frequency and Capacity-tests with accessories by Gambrell, etc. There are three complete sets, the first is a Tinsley-Heaviside with Variable Mutual Inductance, Carey-Foster Ratios and Valve Resonator. This set cost £150 and is unused. The next set is a **CAMPBELL**, also with a range to 11.1 mH. and has a number of accessories. Cost £60. The smaller **TINSLEY** is less elaborate and is a £35 set. For Coil Inductance measurements.

EVERSHED CAPACITY DIRECT READING SET .005 mf. to 1 mfd., cost £40.

8 WHEATSTONE BRIDGES, by Siemens. Cambridge, Nalder, etc., of the G.P.O. and 6-dial plug types with galvo. in centre.

4 SILVERTOWN TEST SETS for insulation and conductor resistance measurements.

8 SUSPENSION MIRROR GALVOS. M.C. Shunts and Lamps. Large glass scales, 2 ft. x 2 ft.

RELAYS HIGH SPEED. Tinsley-Anson Valve-Neon trigger, Siemens 6in. Relay, Creed-Carpenter magnetic, Sullivan Moving Coil Relay, Silvertown Sounder Relay and various G.P.O. models.

MEGGERs. Six of various ranges from 100 volts to 1,000 volts and 10 megohms to 200 meg. Gambrell Resistance Boxes, 1 to 10,000 ohms, window dials.

WAVEMETERS. Sullivan Standard Laboratory Het. No. 130, 8 ranges and No. 108 of 5 ranges. A Gambrell with Weston Milliammeter.

CONDENSERS. Calibrated Variable Condensers with charts by Sullivan. Fixed value mica ditto by Sullivan and Gambrell, etc., to 16 mfd. in steps.

SIEMENS LOW TEMPERATURE PYROMETER. Galvo. keys. Reversing Switches, Interruptor, Moll Thermopile, Cambridge Eindhoven Spring Unit. Electro-scope with scope eyepieces, High Temp. Thermometers. Tiny arc lamps for Micro or Oscillograph 100 amp. focus Osram bulb. 2 Weston Standard Cells.

SWITCHGEAR. High Insulation D.P.C.O. on ebonite pillars. Ironclad motor gear. Quantity of Lab. Resistances from 1/2 ohm to 3,000 ohms, 1/4 amp. to 100 amps.

GENERATORS, etc. Three Motor-Gens. by M.L. Co. 220 v. to 440 v. 100 m/a. Evershed ditto, 220 v. to 1,000 v. 30 m/a, a 1 K.W. 200/1,000 v. D.C. by Newton. Tungar and other chargers.

RADIO SETS, 2 McMichael S.G. Portables. Burn-dept. G.E.C. and Radio LL Superhet. Sets all with valves. A 2 v. Grebe-Armstrong and several frame aerials.

Transmitting helices and 20 pairs of Brown headphones. Two unused Fultographs and amplifier.

There are a large number of other items which would take pages to describe.

PRINTED ILLUSTRATED LIST of this beautiful Laboratory gear is in preparation and will be sent on receipt of 4d. on application.

The apparatus may be viewed at our showrooms at any time between 9 a.m. to 6 p.m.

SUMMER CLEARANCE SALE

Wonderful unrepeatable bargains. A few are listed below.

H.T. MAINS UNITS, famous British make, 220 v. D.C. 15 m/a, 25/-; leatherette case, plug and cord.

A.C. UNITS. 220 v. 50 cycles, 15 m/a, brand new, 45/-, Super A.C. Units, Westinghouse rectifier. List £7, Sale 70/-.

FELLOWS LITTLE GIANT III in Oak Cabinet with three matched valves, 35/-, List £8. Ediswan 2-valve sets, 25/6.

PORTABLE 5-v. SETS by Royal Radio, etc. Guaranteed perfect working order, wonderful range and quality, £7 5s. to clear.

LOUD SPEAKERS. Moving Coil for 220 v. D.C. Mains, £3 10s. Famous M.P.A. Cone speakers. Oak Cabinet, 15s. Boudoir Crystal Sets, 3/-.

M.L. MOTOR GENERATORS, 220 v. to 400 v. 100 m/a, £9. Brand new 2,000 dynamos, motors and alternators in stock. Kindly specify wants. Our new list of 1,000 electrical and radio gadgets will interest you.

ELECTRADIX RADIOS, 218, Upper Thames St., E.C.4

Telephone - - - - - City 0191.

COMPARE THESE FIGURES WITH THOSE OF ANY OTHER 2-VOLT POWER VALVE



The goodness of a valve is determined by the highest amplification factor for the lowest anode impedance. This is expressed as mutual conductance, therefore the higher the mutual conductance the better the valve.

The mutual conductance of the Mazda P.240 is considerably higher than that of any other 2-volt power valve. It will operate a moving coil loud speaker with most satisfactory results.

THESE FIGURES PROVE IT . . .

Amplification Factor	7
Anode A.C. Resistance (ohms)	1,900
Mutual A.C. Conductance (MA/V)	3.7

MAZDA P. 240
PRICE 15/-

The Amazing

MAZDA RADIO VALVES

With Mazda valves in all positions your set will give a performance many times better than before.



THE EDISON SWAN ELECTRIC CO., LTD.,
Radio Division,
1a, Newman Street, Oxford Street, W.1.
Showrooms in all the Principal Towns.

EDISWAN

V.48

Mention of "The Wireless World," when writing to advertisers, will ensure prompt attention.

B2

The Wireless World

AND
RADIO REVIEW
(18th Year of Publication)

No. 562.

WEDNESDAY, JUNE 4TH, 1930.

VOL. XXVI. No. 23.

Editor: HUGH S. POCOCK.
Assistant Editor: F. H. HAYNES.
Editorial Offices: 116-117, FLEET STREET, LONDON, E.C.4
Editorial Telephone: City 9472 (5 lines).
Advertising and Publishing Offices:
DORSET HOUSE, TUDOR STREET, LONDON, E.C.4.
Telephone: City 2847 (13 lines). Telegraphs: "Ethaworld, Fleet, London."
COVENTRY: Hertford Street.
Telegrams: "Cyclist, Coventry." Telephone: 8210 Coventry.
BIRMINGHAM: Guildhall Buildings, Navigation Street.
Telegrams: "Autopress, Birmingham." Telephone: 2970 and 2971 Midland.
MANCHESTER: 260, Deansgate.
Telegrams: "Hiffe, Manchester." Telephone: 8970 City (4 lines).
GLASGOW: 101, St. Vincent Street, C.2.
Telegrams: "Hiffe, Glasgow." Telephone: Central 4857.

PUBLISHED WEEKLY.
Subscription Rates: Home, £1 1s. 8d.; Canada, £1 1s. 8d.;
other countries abroad, £1 3s. 10d. per annum.

Entered as Second Class Matter at New York, N.Y.

As many of the circuits and apparatus described in these pages are covered by patents, readers are advised, before making use of them, to satisfy themselves that they would not be infringing patents.

CONTENTS OF THIS ISSUE.

	PAGE
EDITORIAL VIEWS	571
THE YACHTSMAN'S THREE. By H. F. SMITH	572
RADIO AT THE PARIS FAIR	578
WHY CONDENSERS DIE. By A. L. M. SOWERBY	580
SHORT WAVE CONVERTER	583
CURRENT TOPICS	585
THE LOUD SPEAKER DIAPHRAGM. By N. W. MCLACHLAN	586
LABORATORY TESTS ON NEW APPARATUS	589
WIRELESS THEORY SIMPLIFIED, PART XXXII. By S. O. PEARSON	590
BROADCAST BREVITIES	593
CORRESPONDENCE	594
READERS' PROBLEMS	595

GREAT EXPECTATIONS.

THE coming summer will be no time for idleness in the radio industry. Assuming that sets are to be available next season embodying all modern refinements, then the designers are faced with finding solutions to many difficult problems, both electrical and mechanical. In previous years the pending changes have been obvious, their introduction a matter of course, but so many developments have aroused our interest recently that we look forward to drastic departures from the present-day receiver designs, excepting, perhaps, in the case of portables.

Single-dial control, now so little used, will no doubt become standard practice in the multi-valve receiver, and the circular tuning dials of old will disappear. With the departure of the many tuning controls will go the triode H.F. amplifier, giving way to the universal adoption of the screen-grid valve. To decide upon the best form of detection is by no means easy, bearing in mind the distortion for which each type is responsible and the relative strength of signal each handles and delivers.

Power grid detection will find favour in many designs. All controversies will remain as to the relative suitability and merits of the various low-frequency couplings, but it is probable, as a result of a better knowledge of the correct working conditions of the pentode, that this valve will be more generally used and the output conditions for the retention of quality better respected.

No doubt the greatest problem facing the set designers of to-day is that of a satisfactory arrangement of volume control. Pre-detector and even pre-H.F. control of signal voltage would seem within limits to be the desirable aim, but in so doing, selectivity, quality, and the tendency to regenerate may be seriously affected. Change of screen voltage, grid bias, or the use of the H.F. potential divider as a means of volume adjustment are each not without criticism, and in the more elaborate sets ganged controls applied to various parts of the circuit, both before and following the detector, may be adopted. Automatic volume control by which a uniform signal level is maintained is receiving attention. Selectivity combined with the avoidance of excessively sharp tuning by the use of filters is a feature that many set users may expect, but the application of this property to the tuning on both broadcast and long-wave bands is not without difficulty.

Intensive experimental work is being carried out in the direction of obtaining the best possible performance from the all-mains operated set. It is in this field that many of the new principles already mentioned will find application. Mains sets usually need metal containers, a condition that will turn attention to the chassis-built receiver where the actual type of containing cabinet is left entirely to the tastes of the user. To avoid the errors which might arise from incorrect matching of loud speaker and output stage, set manufacturers may produce also the loud speaker.

In the mains-operated class the ideal set is, no doubt, a high quality local station receiver, fitted with three-way key for alternative programme reception and gramophone reproduction. Such a set might carry a detector current meter, as a visual indicator of the best conditions for quality reception.

This year the manufacturer stands at the branching of many ways in the course that progress is running, not knowing with sufficient confidence in which direction to turn, and doubtful, perhaps, as to the route to be taken by his rivals. Whatever is to be made must be mass-produced for the price to be competitive, and how great is the risk in laying down plant for the making of thousands of sets when they may be eclipsed before the first hundred are completed!

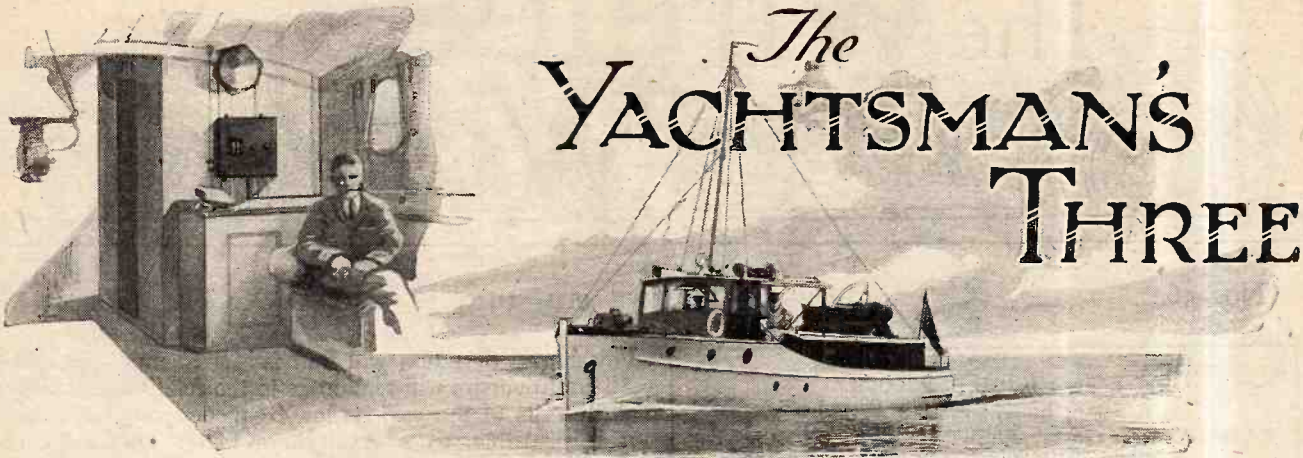

A Compact Long-wave Set for Service Afloat.

By H. F. SMITH.

AS far as is known, there is no broadcast receiving set available which is specially designed for use on board small yachts. At first sight, the conventional portable or transportable with built-in frame aerial might seem to fill the bill fairly well. Actually, it does so under certain conditions, and, indeed, there is no real alternative to this type of set on cabin cruisers without masts or in other cases where an elevated aerial cannot be erected. But the portable set, compact as it is, requires a fair amount of room, particularly as space must be allowed for swinging its frame aerial; its directional

properties can be a nuisance rather than a blessing when frequent changes of course are being made, and it is a rather unhandy piece of apparatus in a tiny cabin or saloon, where every inch of space must perforce be turned to good account.

If the "open-aerial" type of set is decided upon, it is certain that the ordinary kind of domestic outfit as used ashore is bound to offend the susceptibilities of all keen yachtsmen, and particularly those of the hardy amateur "shellback," who, in any case, can only be gathered into the wireless fold by the promise of receiving broadcast weather reports,

SPECIFICATION.

An H.F.-det.-L.F. three-valve receiver for long waves (about 800-2,000 metres) specially designed for use with very short aeri-als.

Aerial coupling: direct, with series condenser.

H.F. amplifier: screen grid valve with tuned transformer.

Tuning: by side-by-side edgewise dials; both circuits can be tuned simultaneously with one hand.

Detector: grid circuit, with conventional values.

Reaction: between detector anode and grid circuits, controlled by differential condenser.

L.F. coupling: high-ratio step-up transformer.

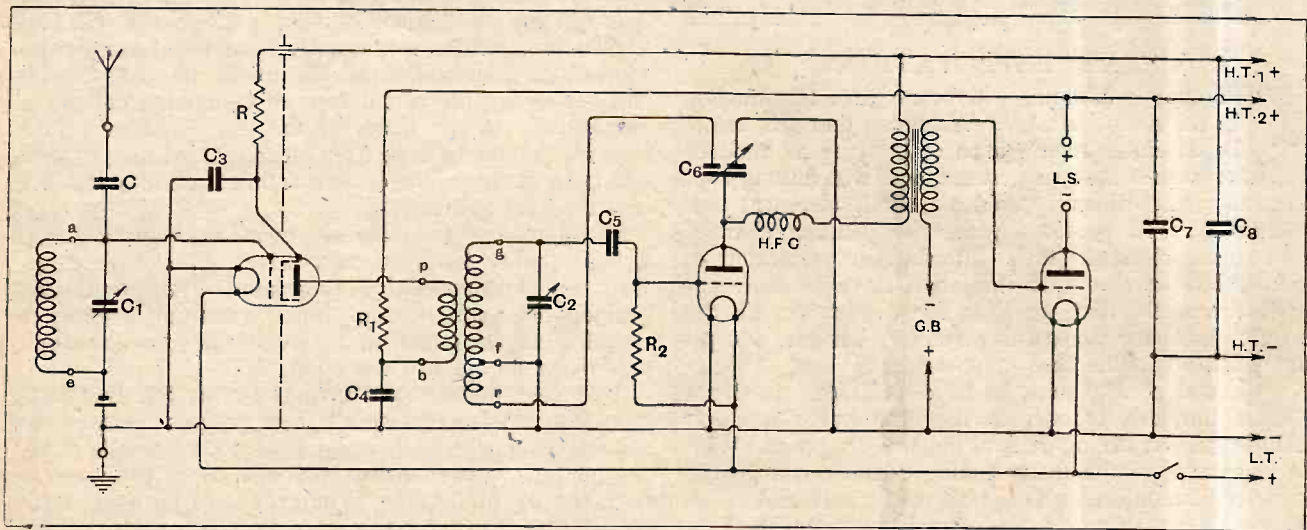

Fig. 1.—Theoretical circuit diagram. C, 0.0002 mfd.; C₁, C₂, 0.0005 mfd.; C₃, C₄, 0.5 mfd.; C₅, 0.0003 mfd.; C₆, differential reaction condenser, 0.0003 mfd.; C₇, C₈, 2 mfd.; R, R₁, 600 ohms; R₂, 2 megohms. Lettering of coil terminal points corresponds with Figs. 4 and 5.

The Yachtsman's Three.—

forecasts, gale warnings, and, just possibly, by the attractions of news bulletins. What they demand is a neat and workmanlike set specially designed for its job, and, above all, compact, with that particular kind of compactness that allows it to be screwed on to the cabin panelling without protruding so far as to get in the way. The dimensions of the receiver to be described in this article are 14in. wide, 11in. high, and 4½in. deep from back to front. The latter dimension is the most important; it can be curtailed by a bare half-inch if necessary, but the other measurements can be reduced quite appreciably. No attempt has been made to reach the irreducible minimum in the matter of size, as to do so would unduly limit the constructor's choice of components, and would make the tasks of assembly and wiring much more difficult.

Having decided tentatively on the dimensions of a container, a circuit arrangement must be chosen to fit it. Anode current consumption must be limited, as it will generally be necessary to depend on dry batteries, and so a maximum of three valves is indicated. Receiving conditions on the water are good, thanks largely (and paradoxically) to the excellence of the "earth" connection, but aerial dimensions are often limited to as little as 15ft. of wire; this means that at least one high-frequency stage is desirable, and, as loud speaker reception is always demanded, an L.F. magnifier must be used. This settles the valve combination; H.F.-det.-L.F., with a provision that the H.F. stage must pull its weight, especially if a fair selection of foreign programmes is to be expected.

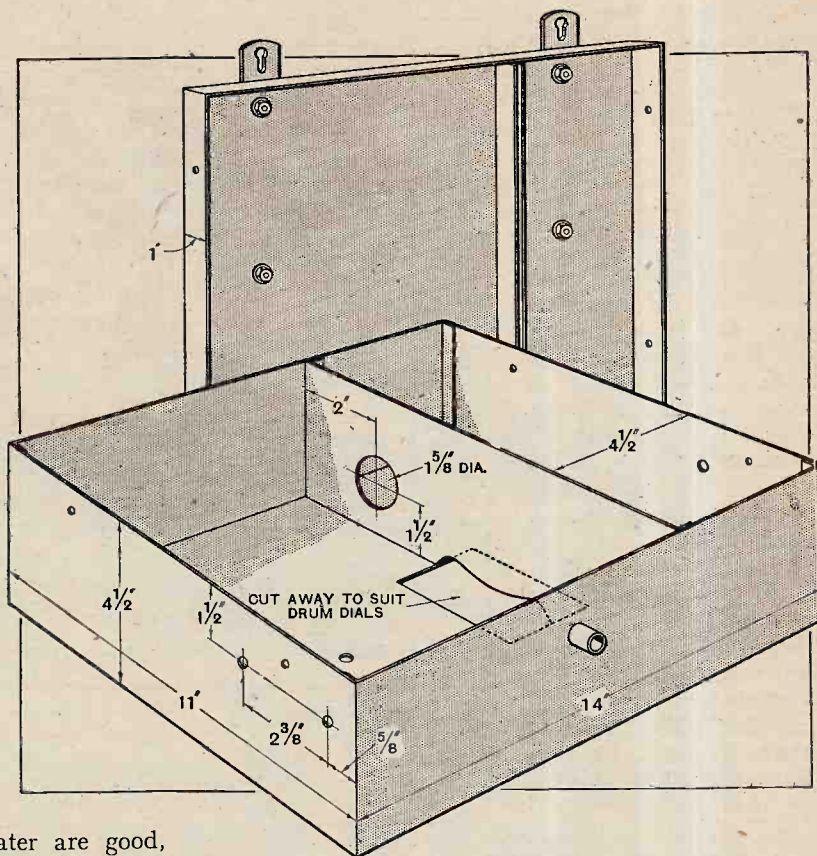
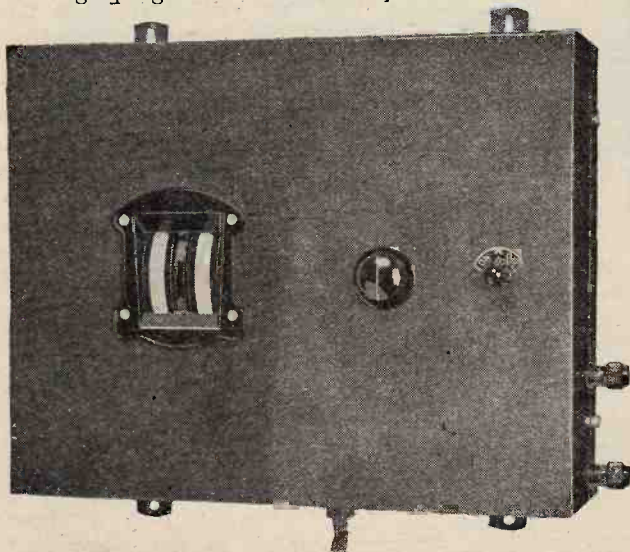

Fig. 2.—Constructional details of the metal case.

As a result of some experience with yacht installations, and after discussing the matter with yachtsmen, the writer decided to concentrate on a long-wave receiver, to the complete exclusion of the medium broadcast band. Around our coasts reception on this latter band is almost completely marred by interference from ships' transmitters, and it is a fact that most yachting venues are within wipe-out range of important shipping tracks. If medium-wave coils were included, they would seldom be used, so it seems that the best use can be made of the available limited space by fitting more efficient long-wave tuning coils than would be possible in a two-range set of the same dimensions. Design is simplified, and the risk of trouble is reduced by taking this course.

It is now widely appreciated that sets with pretensions as to range and selectivity should have an input filter or separately tuned aerial circuit, particularly when a screen-grid, high-frequency amplifier is used, as in the present case. But due to the extremely short aerial length that is normally possible, the selectivity problem, except for 600-metre interference, almost solves itself on board small yachts, and so this complication was judged to be unnecessary. On larger craft the addition of a coupled tuned aerial circuit should be considered, as it will permit of full advantage being taken of the sensitivity of the receiver. Failing this addition, the obvious step to take is to reduce the capa-



The complete receiver. Tuning is controlled by a pair of side-by-side, edgewise dials, and can be operated with one hand.

The Yachtsman's Three.— city of the aerial condenser C (Fig.1).

The container, with its lid, which also forms the back, is shown in Fig. 2. This is made of No. 24 S.W.G. tinned plate, and is a job for a tinsmith or for one of the firms specialising in metal cases rather than for the amateur. The back is fitted with two projecting strips of thin steel, drilled at their extremities with holes to pass wood screws for securing the set to the bulkhead. It also carries a springy channel-section double strip of metal, soldered to its inner surface, which engages with the transverse metal screen of the box to form an electrical seal. The cover can be secured in position by four short No. 4 B.A. screws passing through holes into nuts soldered to

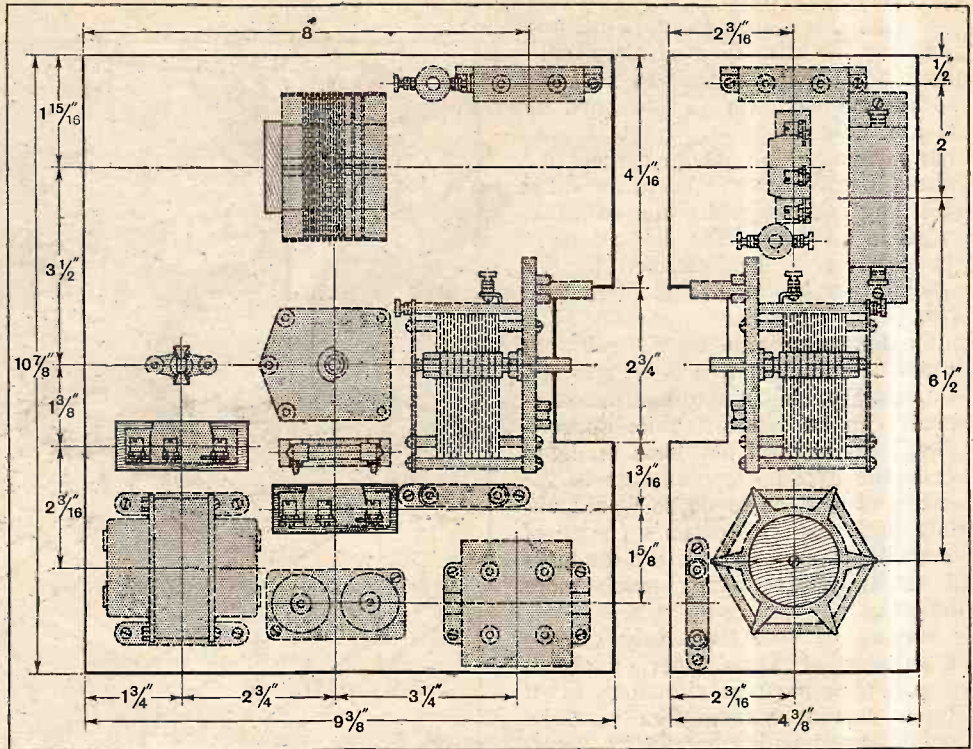

Fig. 3.—Layout of components on the baseboards.

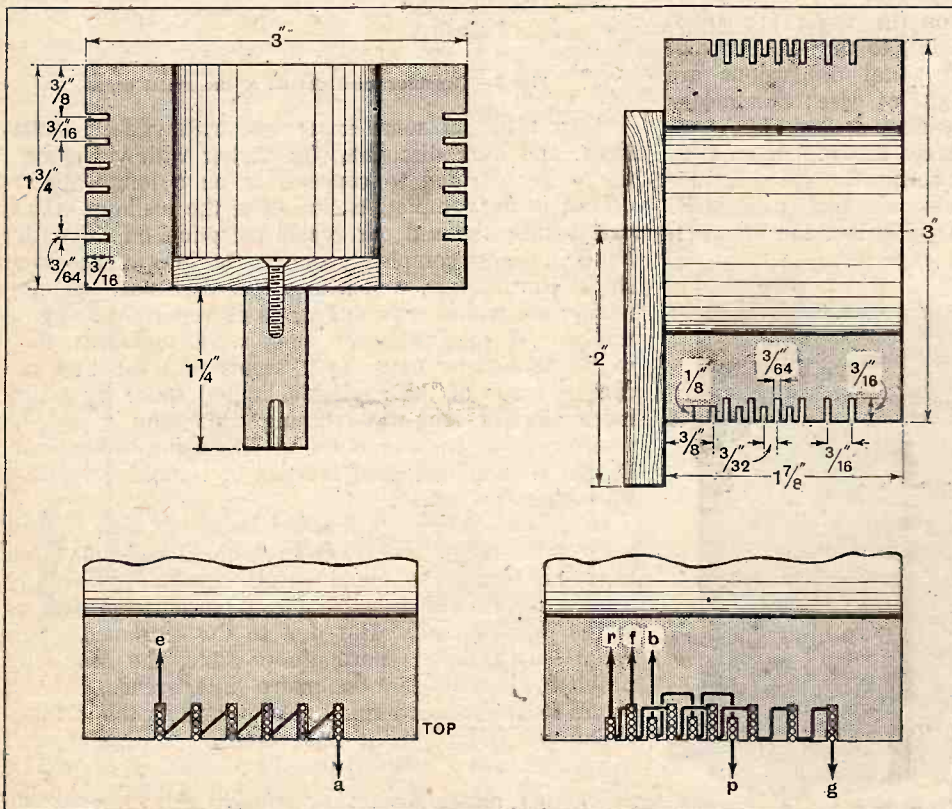

Fig. 4.—Dimensions of the formers for aerial-grid coil and H.F. transformer. Below: sections through ribs, showing disposition and connections of windings.

the inside of the box, or in any convenient manner.

It will be seen that a tubular bush is fitted to pass out a multiple cable serving for battery connections, and that terminals are provided for aerial, earth, and loud speaker connections. Except for the earth, all these terminals must be insulated from the case, either by bushing or by screwing strips of ebonite or paxolin to the metal and drilling oversize clearance soles for the shanks. A good finish can be given to the container with the help of Belco cellulose enamel, or, in the case of a commercial product, the metal can be sprayed externally. Care should be taken to see that the contacting surfaces of lid and container are not painted.

Each compartment is fitted with a three-ply wooden baseboard mounted behind the front

The Yachtsman's Three.—

panel of the case; all components are screwed to these boards, which are held in position by the condenser escutcheon screws and by the fixing bush of the on-off switch. The apparatus in each compartment can, before the baseboards are inserted, be almost completely wired, except for battery-feed interconnections which pass through the transverse screen, and, of course, the necessary leads to the terminals. Thus all wiring is readily accessible, with the sole exception of the external grid bias lead joined to the " - G.B." transformer

relatively shallow ring of slots at the extreme end, and has 25 turns of No. 40 D.S.C. wire. The end of this coil is joined electrically to the beginning of the secondary, which comprises six sections, each with 30 turns of No. 32 D.S.C., and is wound in the same direction. In order to leave room for the interwound primary, the crossing wires between secondary sections must not be taken diagonally from the end of one coil to the beginning of the next, but must be kept down to the tubular body of the former by passing them round a strip of insulating material, or in any other convenient manner.

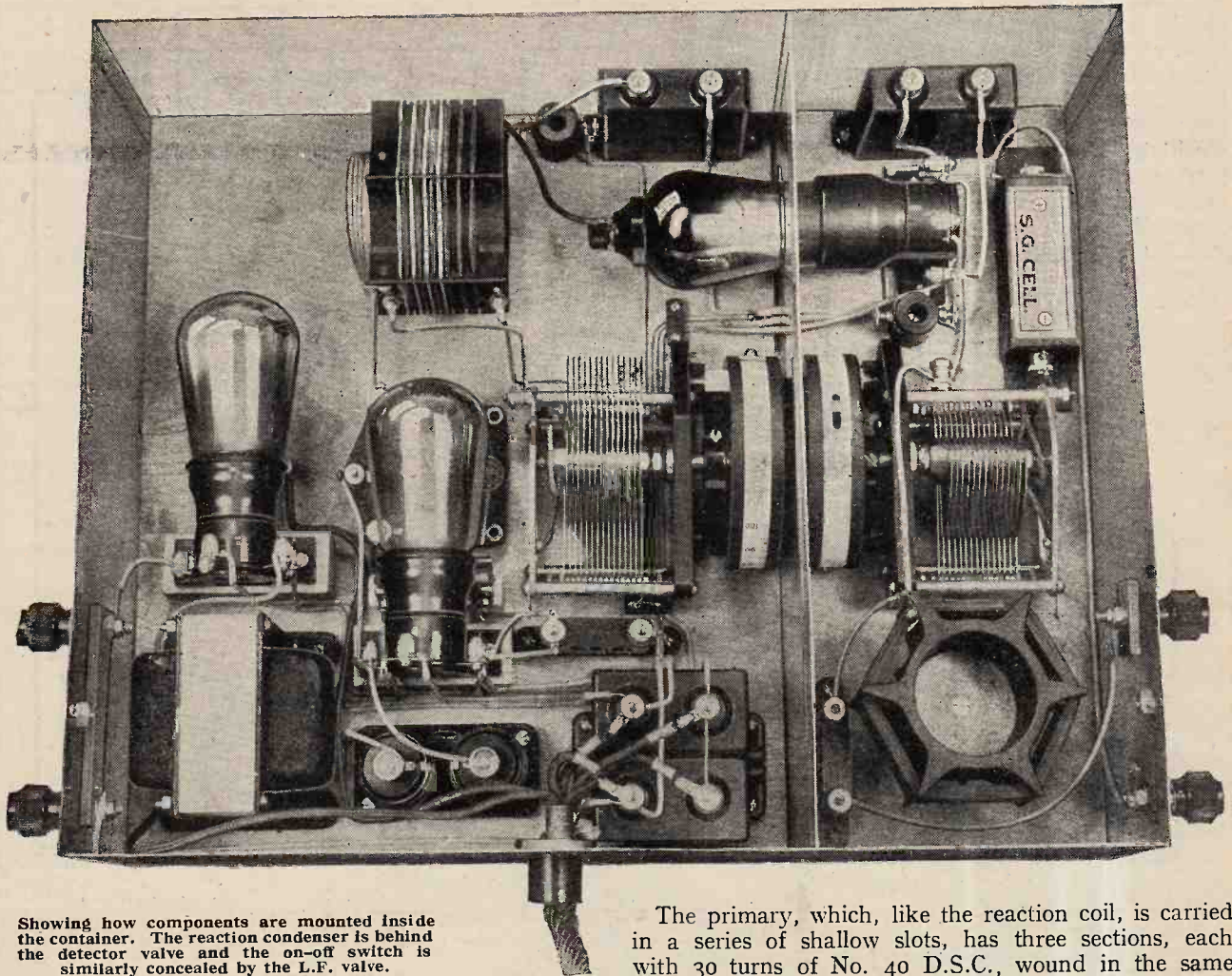

Showing how components are mounted inside the container. The reaction condenser is behind the detector valve and the on-off switch is similarly concealed by the L.F. valve.

terminal; one should remember to put this wire on before the baseboard is finally fixed in position.

A special aerial inductance and H.F. transformer-cum-reaction coil assembly are needed. Construction of these coils, which are wound on slotted ribbed formers, is explained in Fig. 4. The aerial coil is a simple winding, each of the six slots being wound with 28 turns of No. 32 D.S.C. wire. There are three separate coils—primary, secondary, and reaction—in the H.F. transformer assembly; it is convenient to start with the reaction coil, which is accommodated in the

The primary, which, like the reaction coil, is carried in a series of shallow slots, has three sections, each with 30 turns of No. 40 D.S.C., wound in the same direction as the other coils. Again, precautions must be taken against contact between primary and secondary wires, and the interconnections may be looped over an insulating strip. Terminal tags are screwed to the ends of the ribs in convenient positions for external wiring, as indicated in Fig. 5.

One should add the usual warning against making the slots too deep; if the outside diameter of the coil sections is sensibly less than that of the ribbed former, inductance may be too low. As the thickness of wire covering is apt to vary, the depth of slots for the tuned windings as shown in the drawing should be taken

LIST OF PARTS.

- | | |
|---|--|
| <p>2 Variable condensers, drum control, direct drive, right and left hand, 0.0005 mfd., Type No. 3 (Polar).
 1 Differential condenser, 0.0003 mfd. (Pye).
 1 Fixed condenser, 0.0002 mfd. (T.C.C.).
 1 Fixed condenser, 0.0003 mfd. (T.C.C.).
 2 Fixed condensers, 0.5 mfd. (T.C.C.).
 2 Fixed condensers, 2 mfd. (T.C.C.).
 3 Valve holders, horizontal type (Aermonic).
 1 L.F. transformer (Telsen; 7:1).
 1 On-off switch (Benjamin; rotary pattern).
 2 Decoupling resistances, 600 ohms (Wearite).
 1 H.F. choke (Burton; binocular).</p> | <p>1 Grid leak holder (Bulgin; porcelain).
 1 Grid leak, 2 megohms (Ediswan).
 1 Grid cell, 0.9 volt (Siemens).
 4 Ebonite shrouded terminals; Aerial, Earth, L.S.+, L.S.— (Belling-Lee).
 7 Identification Tags; L.T.—, L.T.+, H.T.—, H.T.+1, H.T.+2, G.B.—, G.B.+ (Collett).
 5 Wander plugs (Clix "Springscrew").
 1 Length 6-ribbed former, 3in. dia. (Redfern; deep rib).
 Material for metal container; ebonite, wood, wire, screws, sleeving, etc.
 Approximate cost, including material for cabinet, £4 10s.</p> |
|---|--|

ness of tuning of C_2 , it is a good plan to join the detector grid condenser to the junction between the second and third secondary sections, counting from the end marked *g*, and not to the high-potential end of the tuned circuit, as is shown in the diagrams.

As a detector, a valve of the "H.L." pattern, with an impedance of some 20,000 ohms, is generally the best, though slightly better bass response will be afforded—at the expense of increased H.T. consumption—by a valve of about 10,000 to 12,000 ohms. No very great volume of sound is needed to fill the average yacht saloon, and so an ordinary power valve will generally be considered adequate for the L.F. position.

A word of advice may be offered with regard to installation. Space for batteries can generally be found in a locker, or, failing this, a special box must be made for them and secured in position in any odd corner that is likely to be reasonably dry, the cable being run as neatly and inconspicuously as possible between batteries and set, and clipped to the woodwork with brass saddles. Where an accumulator battery is fitted for the boat, it is convenient to use one or more of its cells for feeding the wireless receiver. As often as not, this battery will be earthed, and, if so, the earth terminal on the set may be ignored.

With regard to an aerial, it is impossible to lay down any hard-and-fast rules, beyond saying that it should be as long and as high as possible. It is not always easy to devise a satisfactory aerial system for a sailing yacht, but very satisfactory arrangements have been devised by insulating a part of the standing rigging, replacing steel wire by phosphor-bronze or some other alloy with high tensile strength

and good electrical conductivity. For ordinary yacht aeri-als of medium length, Ormiston's 4/21 phosphor-bronze wire is suitable.

Insulation generally requires greater care afloat than ashore; small "Pyrex" aerial insulators have been found to stand up well to their work, while a bowl insulator of the same material makes a good water-tight lead-in if it is fitted with rubber washers at each end. The domestic type of lead-in tube is almost useless for this purpose, as it is lacking in mechanical strength, and is likely sooner or later to develop a leak.

In the matter of connections for the batteries, it may in some cases be preferred to fit an external terminal strip, projecting through the underside of the case. This will tend to complicate constructional work, but will simplify the task of dismantling and reinstalling the receiver; it may be advisable to remove it when the boat is laid up.



"All shipshape and Bristol fashion": the set installed in the saloon of the 55ft. motor cruiser *Diana*.

"RADIO at the PARIS FAIR"

Notes on a Visit to the "Foire de Paris."

ALTHOUGH it is by no means representative of the radio industry in France, the section devoted to wireless at the annual "Foire de Paris" is an interim exhibition which serves to give some indication of the general trend of development of sets which will be more fully represented at the big show held annually in the autumn.

The superheterodyne is still almost the universal circuit, and practically every exhibitor confines his best sets to this principle, with the exception of one or two firms not of French origin, or, at least, firms which are largely influenced by designs of associated firms abroad.

When we enquire what is the reason that superheterodynes still hold sway in France, we are told that



Some Interesting Tuning Devices.

two long-wave stations make the problem of selectivity a very real one, necessitating either the adoption of the superheterodyne principle or a multi-stage high-frequency amplifier.

In France the French stations themselves appear to be less popular than the transmissions from abroad, which is another reason why selectivity and range are demanded.

Because set manufacturers in France nearly all adhere to the same circuit principle, they have to look in other directions for refinements or developments on which to base competition between themselves. One direction in which ingenuity has been shown is in endeavouring to simplify the process of tuning and station finding, and all sorts of devices are in evidence. A new device which has been adopted by more than one set maker is known as "Valundia," which is described as the pianola of wireless. Here a metal plate about three inches long carries on one side a list of the short-wave stations, and on the other side the long waves (Fig. 1). By the manipulation of a knob the plate can be reversed so as to show either the short or the long waves, and the switch at the same time changes over the set controls to long- or short-wave reception. On either side of the plate are the two controls for tuning the superheterodyne, and as these are moved drums on either side of the plate are rotated, the drums being wrapped round with paper on which are traced lines corresponding to the tuning of the receiver; when these lines come opposite the name or wavelength of the station required the set is then in tune.

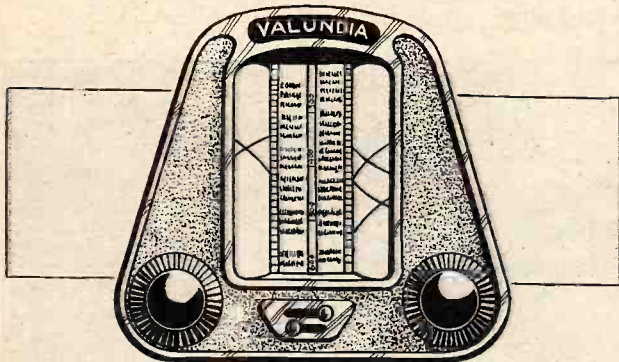

Fig. 1.—The Valundia tuning device which facilitates the rapid identification of short- and long-wave stations.

the principle is an ideal one, providing the utmost possible in selectivity and range. Having had the opportunity of testing out one or two models under reception conditions in Paris, we are rather forced to the conclusion that, until recently, at least, the superheterodyne has probably been the essential set for Paris, and Paris requirements have no doubt controlled the designs of all French sets.

Outside aerials are almost unknown in Paris, largely because they are not permitted in the terms of leases of flats and houses. The number of stations working in Paris and the presence of

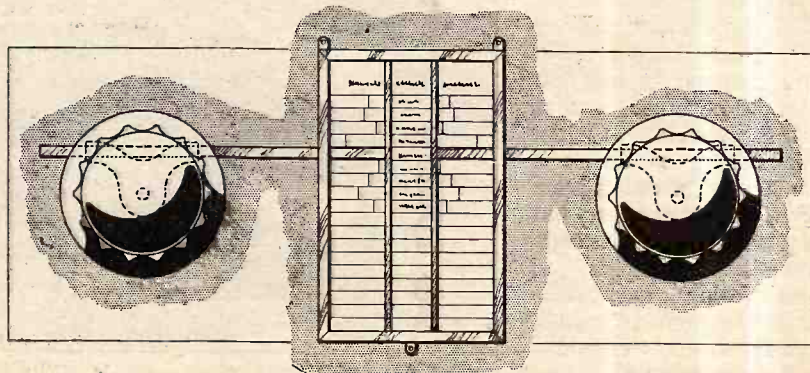

Fig. 2.—An arrangement in which two condenser spindles are linked by horizontal rods to a station log indicator: marketed by Duvivier.

Radio at the Paris Fair.

Another device simpler in idea is produced by the firm "Duvivier," and this consists of two horizontal rods simply coupled to the spindles of the tuning condensers and carrying two vertical rods which move over a framed card on which appears a list of stations. When a station is tuned in, marks are made in line with the station name on the card corresponding to the positions of the vertical rods (Fig. 2). It is claimed that this device can be quickly fitted to any receiver depending upon the manipulation of two controls for tuning.

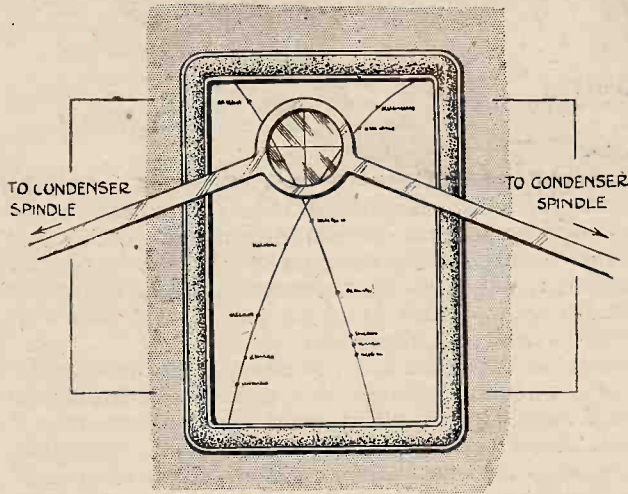

Fig. 3.—A device which permits of a single control of two-tuned circuits. It is incorporated in one of the receivers of P. Moreau et Cie.

Yet another device of the same character consists of two rods coupled to the tuning controls and intersecting at a ring into which is fitted a glass with cross lines, so that the ring can be moved in any direction over a card, and where stations are received an identifying mark is made where the lines of the glass come to rest (Fig. 3).

Ingenious Geared Tuning Arrangements.

An unusual dial is fitted to a condenser known as "Le Tubus," made by "Duvivier" (Fig. 4). The condenser itself is of a type which is not unfamiliar, but instead of one dial there are two geared like the minute and hour hands of a clock, and degrees are read on one and fractions of degrees on the other.

These ingenious but rather roundabout methods of endeavouring to simplify tuning would probably not make a strong appeal to the British user, but it must be remembered that in France wireless has never become popular as a hobby, and to the vast majority of users it still remains a complicated mystery where any simplification of tuning may be considered an advantage.

Portable sets appear to be extremely popular in France, and almost every set manufacturer has one or more types of portable. The fact, too, that frame aerials are in general use makes most of the receivers, if not actually portable, at least transportable from room to room, and this has an advantage, especially as most of the better sets now operate from the mains.

B I

The firm of P. Moreau et Cie were showing what would probably be regarded as the most up-to-date equipment of the exhibition. This was a complete installation bound in a very handsome cabinet and containing a seven-valve receiver, gramophone turntable and pick-up, accommodation for records, and, in addition, a complete Belinographe picture receiver. It would seem to us that this complete set is a little before its time, as enquiry does not seem to indicate to us that there is any very general interest in picture reception.

Moving-coil Speakers and Better Quality.

There are indications of an increasing interest in quality reception, and moving-coil speakers are more in evidence. One firm, "Miophone," employs a permanent-magnet moving-coil loud speaker of the type familiar to British users. The speaker is incorporated in a compact cabinet, which also houses the complete receiver operating from the mains—the set is a ganged 3 H.F. type with detector and 1 L.F. stage, and the coils appeared to be of British make. The price of this set complete is 2,750 francs.

Many of the sets shown would be regarded as competitive in price with British types, cabinet self-contained superheterodyne sets being available at prices ranging from £12 upwards.

Naturally, there were some "atrocities" to be seen,

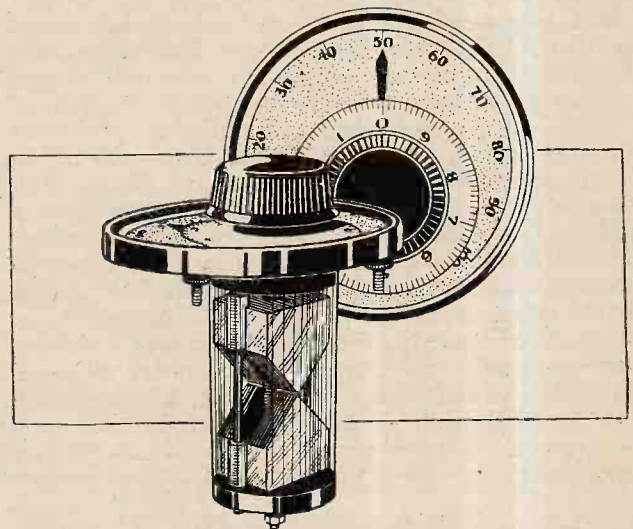
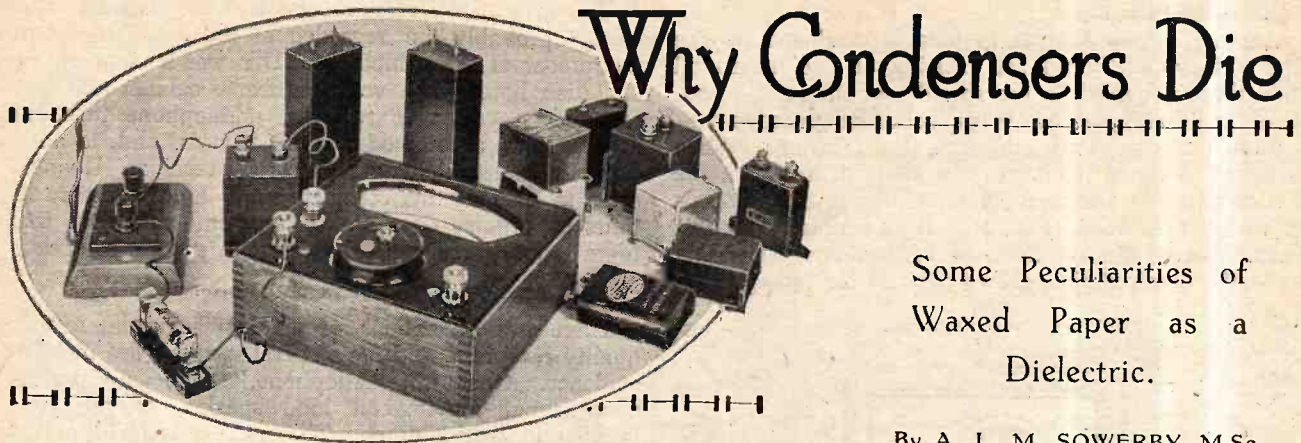

Fig. 4.—A tuning unit known as "Le Tubus," made by Duvivier. The two dials are geared like the minute and hour hands of a clock.

notably a receiver whose elaborate cabinet was evidently meant to offset the fact that there were some twelve or more tuning knobs and controls scattered about on the panel, the knobs being of all shapes, sizes, and colours. It is scarcely surprising that this "meuble de luxe" was amongst the highest-priced sets on exhibition.

We could not help noticing that one exhibitor had allowed his optimism and enthusiasm for his products to exceed his modesty, since on the day of the opening of the show he was distributing pamphlets describing his product as the outstanding feature of the "Foire de Paris," admired by thousands of visitors to the Show on account of its many "perfections."



Why Condensers Die

Some Peculiarities of Waxed Paper as a Dielectric.

By A. L. M. SOWERBY, M.Sc.

TO most of its users the paper-dielectric condenser, of the type employed for smoothing and decoupling, is simply a box of mystery with knobs attached. The user glances at the capacity-rating to make sure it is right for his purpose, connects a wire to each of the aforesaid knobs, stows the condenser away in an obscure corner of his receiver or mains unit, and promptly forgets all about it.

From the point of view of putting together a set that works, such cavalier treatment of the condenser is well enough, but those who like to know a little more about the components they use will always feel a little uncomfortable at such a purely mechanical proceeding. Besides, the paper condenser is rather an interesting little component, and its behaviour is affected by all kinds of apparently extraneous influences. Even apart from its inherent interest, it is just as well to have a nodding acquaintance with some of the outstanding peculiarities of the paper dielectric in order to ensure that any condenser that is to be fitted shall be worked under conditions that are favourable to a prolonged life. For if a condenser, particularly a smoothing condenser in a mains unit, should break down, large currents will flow along various unauthorised paths, bringing death and destruction, if not to the listener, at least to a number of the most expensive components in his equipment.

Wax Dielectric not Paper.

Those who wish to make a comprehensive study of condensers are referred to a well-known book, written primarily from the standpoint of the designer and maker of condensers, which covers the whole subject very fully.¹ The present writer has recently been looking through that book, and has picked out from it those points in connection with condensers using paper for the dielectric which are most likely to be of value and interest to those who are mainly concerned with the technique of wireless reception.

It is fairly safe to say that practically all the condensers of capacity greater than 0.1 mfd. that are used in a wireless set and its associated apparatus have paper

as the dielectric. Mica condensers are the rule for the smaller capacities on account of their longer life and higher insulation, but the expense of a mica condenser rises so rapidly with the capacity that the use of paper condensers is almost universal for all capacities over about a tenth of a microfarad.

A paper condenser is not quite what its name implies. The electrodes, or plates, must naturally be made of a conducting material; thin metal foil, or sometimes a metallic coating on the paper itself, serves this purpose. The paper does not behave as the dielectric, except incidentally, but is really provided as a means of spacing the foils apart from one another, and as a carrier for the true dielectric, which is usually wax, though occasionally oil is used.

The Electron Theory.

In outline, the method of construction is to interleave the foils that serve as electrodes with sheets of plain paper, after which the whole is rolled up, dried, impregnated with dried paraffin wax, and sealed up in an airtight container. Essentially, then, such a condenser consists of two metallic electrodes of large area, separated by a thin layer of wax, the latter being supported in the interstices of paper to ensure that it is of constant thickness throughout. No special interest attaches to the foil electrodes; all the points that concern the user are bound up with the behaviour of the paraffin-wax dielectric. We will therefore devote a little attention to the properties of dielectrics in general, and of wax in particular.

The fundamental distinction between a non-conductor, such as wax, and a conductor, such as copper, is to be found in the fact that the conductor contains free electrons and the insulator does not. If an electric current is passed through a piece of copper wire, there is no visible change in the wire itself, even if the current is allowed to flow continuously in one direction for a prolonged period. The atoms of copper, therefore, do not themselves move. But with the aid of electrical instruments we can readily detect that something is happening in the wire; moreover, as anyone who has used a moving-coil meter knows, that "something" has direction as well as mere existence. A phenomenon that

¹ "Electrical Condensers" by Philip R. Coursey.

Why Condensers Die.—

takes place in a wire, and can be reversed in direction by appropriate means, can only be interpreted as the flow of something along that wire. Since we know that the atoms do not move—if they did, the material of which the wire is composed would be bodily transported from one end of the wire to the other—the carriers of the electricity must be something smaller; to wit, the electrons, which form the outer structure of the atoms of the copper.

The necessary condition that a substance must fulfil before it can be classed as a conductor of electricity is that its atoms can part with electrons. When an electric current flows, electricity is handed on from one atom to another all down the wire, electrons being passed on as buckets of water are passed along from man to man in a chain of fire-fighters.

The Charging Current.

If in any substance the electrons are so firmly attached to their parent molecules that they cannot move away from them, then the substance in question cannot convey an electric current from one point to another; it is, in fact, an insulator. If an electromotive force is applied to an insulator, then, although the electrons cannot actually leave their parent molecules, they still are subject to the impelling force that, in a conductor, would cause their migration. It is probable that under the action of an E.M.F. some of the electrons do move to a small extent, but are unable to move far enough to leave the molecules of which they form a part. There is thus a momentary current when the E.M.F. is first applied, and when this current ceases the molecules of the insulating substance, or dielectric, are distorted and in a state of strain.

This picture fits in well with the known behaviour of condensers; if an E.M.F. is applied to the plates there flows a momentary current which corresponds to the movement of the electrons within the molecules of the dielectric between the plates. That the electrons are ready to "spring back" to their normal positions, so setting up a momentary current in the reverse direction to the original charging current, will not be news to any who have received unexpected shocks from condensers inadvertently left charged.

This conception of the behaviour of a dielectric subjected to electrical stress at once suggests that, if the E.M.F. applied to a condenser is only great enough, a few electrons may be torn forcibly from their molecules, so that the dielectric begins to carry a small current, and may even break down altogether. That this is actually the case is well known, and the voltages necessary to disrupt various insulating substances have been measured by many experimenters. For paper impregnated with paraffin wax, the dielectric strength is some 200 kv/cm. One may wonder, if a centimetre thickness of waxed paper will stand up to nearly 200,000 volts, that paper condensers ever break down, but it must not be forgotten that the thickness of impregnated paper used in condensers is quite small. A capacity of one microfarad, using a dielectric thickness of one centimetre, would nearly fill a small room.

Once the dielectric begins to carry a small current the

freed electrons, moving through the body of the material, will bump into other severely strained molecules, and knock additional electrons out of them in turn. This effect is clearly cumulative, so that the passage of even a small current is only the first stage in the complete breakdown of the insulator.

If the voltage applied to a condenser is slowly increased until breakdown takes place, it is usually found, on conducting a post-mortem, that the dielectric is punctured at one point only. This suggests that in the stages immediately preceding breakdown, when the leakage current is high, this current is nearly all being carried by the weakest part of the dielectric, and is not distributed evenly throughout the whole of it. If this were the case we should expect that the local heating set up by the passage of the leakage current would help to disintegrate the dielectric at the weak point, especially as it is known that both the dielectric strength and the insulation resistance of paraffined paper decrease very appreciably as the temperature is raised. The first of these effects is shown in Fig. 1 in the form of a curve, while the second is illustrated by the fact that a rise in temperature from 68° F. to 104° F. may reduce the breakdown voltage by as much as 25 per cent.

Voltage Test Rating of Condensers.

That the local heating due to the leakage current does actually play quite a considerable part in bringing about the complete breakdown of the condenser may be inferred from the fact that a condenser will stand

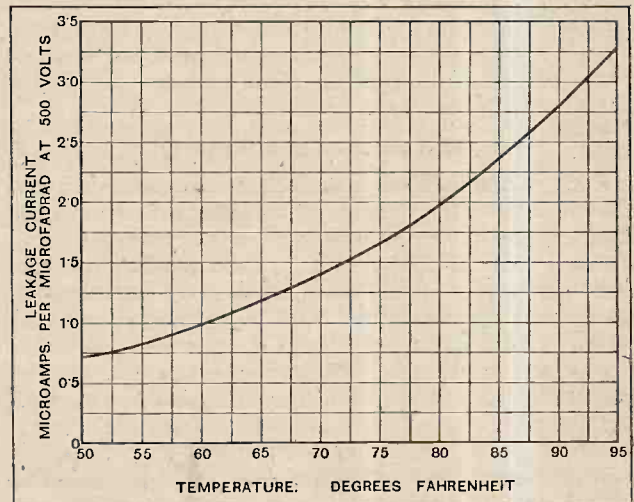

Fig. 1.—Variation of leakage current through foiled paper condenser with temperature. The leakage current rises quite rapidly as the temperature is raised. Data taken from "Electrical Condensers."

for a few seconds a voltage which, if continuously applied, will puncture the dielectric. A condenser that has been tested by the manufacturers at, say, 1,000 volts, is not necessarily suitable for continuous running at that voltage; the test-voltage so proudly flourished before the dazzled eyes of the prospective buyer may be one that the condenser will only withstand for the duration of a "flash test."

The voltage-rating of condensers is a matter in which the average user has very vague ideas; this is natural

Why Condensers Die.—

enough, since some makers give maximum working voltages, others give test voltages based on an A.C. rating, and still others give D.C. test voltages. Where the working voltage is given, the purchaser's duty is clear enough; he must refrain from exceeding it. When all that is given is a test voltage it is safe to assume that the products of a first-rate firm, with a good name to maintain, may be worked at a voltage which never exceeds, even momentarily, one-half of the test voltage used. If the maker's reputation is unknown, it is

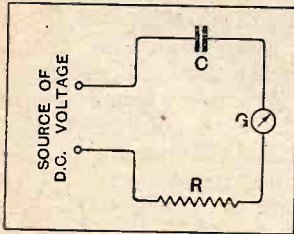

Fig. 2.—Circuit for measuring leakage current through a condenser. C is a condenser under test; G a galvanometer or sensitive microammeter, and R a safety resistance to prevent the condenser from being damaged by too heavy a charging current. In addition, G should be shorted out for the few seconds during which the charging current is flowing.

safer to choose a condenser that has been tested at not less than three times the voltage that it is to be called upon to withstand in use. From what has been said about the deterioration of the dielectric brought about by the heating caused by a leakage current, we may conclude that a measurement of the leakage current taken by a condenser is a fairly reliable guide to its condition. If, owing to old age or previous ill-treatment, a condenser is so far decayed that it takes any appreciable leakage current on the appli-

How to Test Insulation Resistance.

cation of the voltage it is expected to withstand, it is reasonably safe to conclude that complete breakdown is not very far off. It may be postponed for days or even weeks, but the condenser will almost certainly not last for months or years.

If a galvanometer or sensitive microammeter is available, it is not very difficult to measure with reasonable accuracy the insulation resistance of a condenser, using a circuit such as that of Fig. 2, and reading the current that flows. For a condenser in good condition the current passing when 200 volts is applied should not exceed one microampere ($= 1/1,000$ th milliampere) per microfarad of capacity. Most condensers, when new, pass much less current even than this, so that measurement without a sensitive instrument is not easy. But it is perfectly safe to say that any condenser which passes a current great enough to produce even the smallest deflection of an ordinary milliammeter is quite untrustworthy in any position where it will be called upon to withstand high voltages. It can, however, be put on "light duty" suitable to its aged and infirm condition; for example, it might be employed to shunt a grid-bias battery or to connect cathode and heater of an indirectly heated valve.

Those who wish to test condensers of large capacity, using the circuit of Fig. 2, are reminded that a very heavy momentary current (the charging current) will flow into the condenser whether it is leaky or not, and that this momentary current may damage, or even burn out, a sensitive instrument. The latter should be short-circuited by a piece of copper wire joined across its ter-

minals at the moment when contact is first made with the source of voltage. The short-circuit is then removed from the instrument, and the leakage current observed. Owing to a phenomenon known as dielectric absorption, the current will drop slowly to its final value; for laboratory purposes the current is read sixty seconds after the application of the voltage, and the temperature of the condenser is kept at 60° F. for the test, or variations from this temperature are allowed for.

If the condenser is being tested with a voltage not far below the maximum that it is rated to withstand, it is advisable to charge it through a resistance of a few thousand ohms, as too heavy a charging rate is liable to damage the dielectric. Similarly, the charged condenser should not be "shorted"; the spark is undoubtedly attractive, but it is much kinder to the condenser to discharge it more slowly through a resistance.

Moisture the Primary Cause of Deterioration.

It might be thought that a condenser, if sound in the first instance, would continue indefinitely to remain in good condition, provided that it was never subjected to a voltage high enough to cause damage to the paraffin wax that constitutes the dielectric. If it were possible to preserve the condenser from all external influences, this might, perhaps, be true, but in practice a condenser deteriorates steadily from the day it leaves the hands of its makers. The primary cause of the deterioration is to be found in the absorption of moisture from the

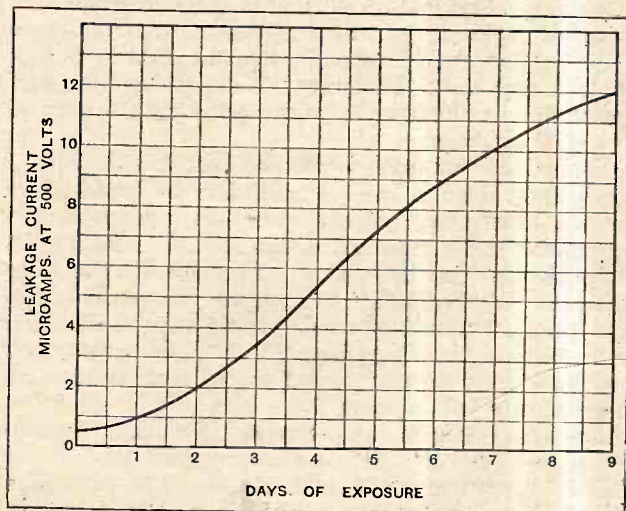
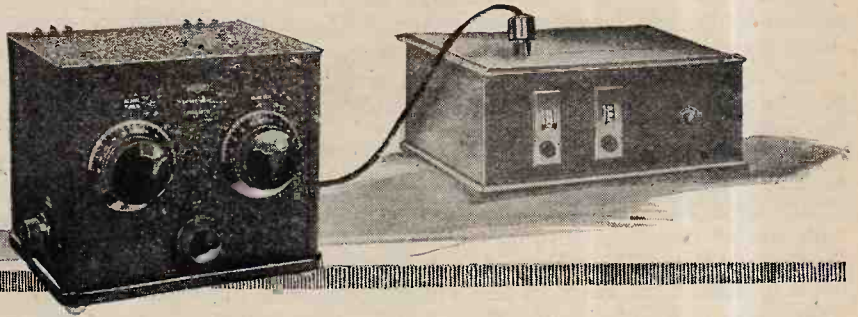

Fig. 3.—Increase in leakage current of paper condenser on exposure to air. The rapid rise in leakage current is due to the absorption of moisture. It is this process, enormously delayed by sealing the condenser into an airtight case, that causes the steady deterioration of every paper condenser. Data taken from "Electrical Condensers."

atmosphere; paraffin wax is very hygroscopic, and its dielectric properties suffer very considerable damage when it is contaminated with even small traces of moisture. It will be seen by Fig. 3, how rapidly the insulation resistance of a paper condenser can fall if no attempt is made to protect it from the atmosphere. All paper condensers are very carefully freed from moisture during manufacture, and are then sealed up in a container that is as nearly as possible air-tight, but, even so, it is impossible to exclude moisture indefinitely.

SHORT WAVE CONVERTOR



A Useful Magnum Accessory for Broadcast Receivers.

MANY owners of broadcast receivers are attracted by the fascination of short-wave reception, but hesitate to purchase or construct a complete short-wave receiver on the grounds that such a course necessitates the duplication of a considerable portion of their existing equipment.

This perfectly reasonable objection is successfully surmounted by the unit under consideration, for it makes use of the L.F. stages and batteries of any existing receiver without involving any modification of the circuit. All that is necessary is to transfer the detector valve from the existing set to the short-wave unit and to insert in its place an adaptor which is connected to the short-wave unit by a multiple cable.

The Magnum short-wave convertor should not be confused with the numerous examples of superheterodyne short-wave units available. Its principal function is to substitute in a convenient manner short-wave coils for those already existing in the broadcast receiver and to operate the detector valve under conditions better suited to short-wave reception.

It will be seen from the circuit diagram that the connections follow standard short-wave practice. The aerial is coupled through a small variable condenser and "aperiodic" coil of comparatively fine gauge wire to a tuned secondary circuit. The latter is wound with heavy gauge tinned copper wire, spaced and located in a spiral groove on a cylindrical ebonite former. The reaction coupling coil is wound on the same former, and six-pin contacts are provided, so that the coil units are compact and interchangeable.

The detector valve functions as a leaky grid rectifier, and the grid condenser and leak values are specially chosen for short-wave work. A potentiometer connected across the filament circuit enables the positive grid bias to be adjusted to a suitable value.

There are only three leads in the multiple cable connecting the short-wave unit to the standard receiver. Two of these are for the filament supply and the third for the anode circuit of the detector valve. Thus the anode current to the short-wave detector passes through the coupling (resistance or transformer, as the case may be) of the first L.F. valve in the broadcast receiver. A grid socket is left in the adaptor to facilitate easy insertion in the detector-valve holder, but no connection is made to this socket, so that the performance on short waves is unaffected by the existing tuned-grid circuit in the main receiver.

In a unit of this type, which is intended to work with all sorts and conditions of sets, adaptability is of the first importance. The designers of the Magnum unit are fully alive to this aspect of the problem, and provision is made for every necessary adjustment.

For instance, it is well known that the detector anode voltage and grid bias must be carefully adjusted in relation to each other if smooth reaction control without backlash is to be obtained. Now, the detector H.T. voltage available from the existing receiver may be fixed, and the grid bias must be capable of adjustment to the correct corre-

sponding value. It is for this purpose that the filament potentiometer has been provided, and intelligent adjustment of this control will do much to ensure a successful performance on short waves. There is no standardised method of connecting the filament sockets of a valve holder, nor is it possible to trace the leads in the multiple cable, so that it is impossible to say which end of the potentiometer will be negative and which positive until the set is put into operation. It will then be found that at one extremity of the movement of the potentiometer knob the overlap or backlash in the reaction control at the point where the set goes into

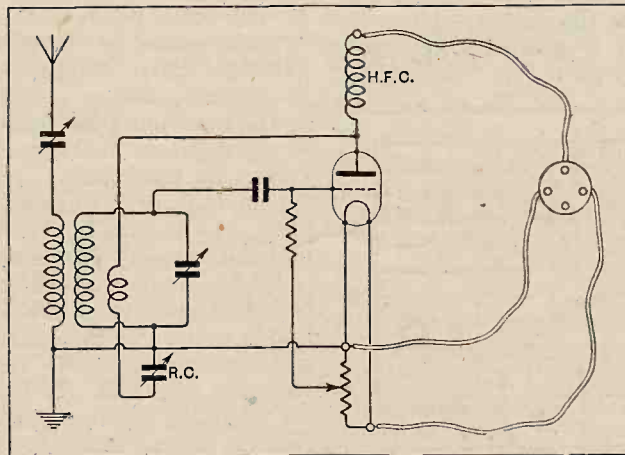

Fig. 1.—Circuit diagram of the Magnum short-wave convertor. The three flexible leads to the valve adaptor are bound together in a multiple cable.

Short Wave Converter.—

or comes out of oscillation is a maximum; this is the positive end of the potentiometer. At the negative end there is no backlash, but signals are weak. The procedure should be to work as near as possible to the positive end consistent with the attainment of smooth reaction.

Another invaluable control is the "aerial coupler" situated on the left-hand side of the cabinet. This control is in effect a small variable condenser in series with the aerial, and performs a number of important functions. Being in series with the aerial capacity it helps to reduce the effect of the latter capacity on the wavelength range of the tuned secondary circuit which would otherwise be shifted upwards. Also it restricts the transfer of the H.F. resistance of the aerial system to the secondary circuit, which might otherwise have the effect of preventing oscillation of the valve as well as general inefficiency and reduced selectivity. Finally, the occurrence of "blind spots" in the oscillation range of the receiver can be avoided by careful adjustment of the coupling condenser. The aerial system includes both inductance and capacity, and therefore has a natural period of oscillation together with harmonics. Whenever one of these points is reached the radiation resistance of the aerial circuit goes up and energy is drawn from the valve. It is for this reason that more reaction is required to produce oscillation and a blind spot is produced. The trouble is easily cured by decreasing the aerial coupling. Fig. 2 illustrates this point conclusively, for it will be seen that when the coupling is weak the degree of reaction required to maintain oscillation is practically constant (continuous curves), whereas when the coupling is

tight (dotted curves) careful attention to the reaction control is necessary to keep the detector on the point of oscillation. In fact, at one point in 20-40-metre range the receiver ceases to oscillate even with the reaction control at maximum. Of course, if the coupling is reduced too much a marked falling off in signal



Magnum short-wave converter and spare coil unit. The cabinet is of metal with crystalline black enamel finish.

strength will result. The correct adjustment of the aerial coupling is therefore a matter of compromise between signal strength and the achievement of a reasonably constant reaction control setting.

The freedom from blind spots with a loose aerial coupling proves that the design of the H.F. choke is correct for the band of frequencies covered by the unit. As an H.F. stopper, too, the choke is perfectly efficient, and the multiple cable is absolutely dead as far as hand capacity effects are concerned.

In the matter of performance the Magnum unit can be relied upon to give a satisfactory account of itself, and is well up to the standard of efficiency one expects from a well-designed reacting detector short-wave receiver. Naturally the volume obtained depends upon the degree of L.F. amplification available and is independent of the range of the unit. Numerous European broadcast transmissions were received at good strength and with little fading, and at a late sitting under rather unfavourable conditions as regards local interference. Pittsburgh East (W8XK) was easily resolved and the carrier waves of Long Island (W2XV) and Bound Brook (W3XL) were identified without any difficulty.

As a concluding test it was definitely confirmed that the tuning of the auxiliary short-wave unit is unaffected by the H.F. circuits in the main receiver.

The makers are Burne-Jones and Co., Ltd., 296, Borough High Street, London, S.E.1, and the price, including two coil units for wavelengths from 20 to 80 metres, is £4 10s. Extra coils for other wavelengths are available, priced 7s. 6d. each.

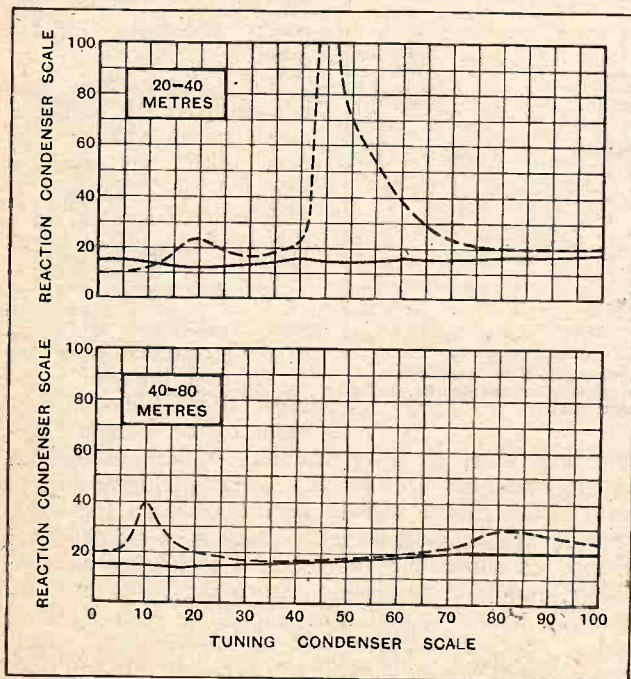

Fig. 2.—Curves showing the relationship between the tuning and reaction dial readings. The full line curves are for loose aerial coupling and the dotted curves for tight coupling, i.e., with the "Aerial Coupler" control near maximum.



Events of the Week

in Brief Review.

RADIO STAMPS IN DENMARK.

Special stamps are on sale throughout Denmark in support of a fund to provide wireless sets for the sick and aged.

o o o o

ITALY TALKS TO HER COLONIES.

"Patro Smeraldo," Italy's new colonial short-wave station at Rome, is now in regular operation with a power of 12 kW. The wavelength is 25.4 metres.

o o o o

WIRELESS PATENTS INCREASE.

During 1929 patent applications concerning wireless inventions exceeded those of the two previous years by nearly 50 per cent., according to the recently published report for 1929 of the Comptroller-General of Patents. A marked increase was shown in applications relating to thermionic valves and photo-electric cells.

o o o o

STORM OVER U.S. RADIO CENSUS.

Trouble has arisen in America over the now famous question in the census forms: "Have you a radio?" If radio sets are included, say the protesting parties, why not also pianos, vacuum cleaners, washing machines, and a number of other domestic appliances whose manufacturers would welcome statistics?

It is understood that radio got through the census mesh following influential tactics in the Senate by a friend of the Radio Manufacturers' Association.

o o o o

RADIO-TELEPHONY IN SHIP TRIALS.

An interesting wireless experiment was permitted by the Post Office in connection with the *Britannic* trials off the Clyde last week. Temporary wireless telephone installations were fitted in Harland and Wolff's offices and on the ship, so that representatives of the owners and builders were constantly in oral communication over distances up to 150 miles during the three days' trials.

The *Britannic* is fitted with a Marconi valve installation and direction-finder. A new development in marine work is the two-valve receiver which covers the entire commercial waveband from 15 to 20,000 metres. Hitherto two receivers have always been fitted.

o o o o

MOROCCO'S EUROPEAN RADIO LINK.

The postal administration in Morocco has ordered a short-wave plant of 7 kW. for the establishment of a regular telegraph and telephone service with France. The French transmitter and receiver will be at St. Assise and Villecresnes respectively.

B 17

OLDHAM SAYS "NO."

Unlike the tramway authorities in Birmingham, Nottingham, and other towns, the Oldham Tramways Committee has decided not to take any action at present in reducing interference to broadcast reception caused by the running of trams.

o o o o

TELEPHONING TO INDIA.

Negotiations are in progress between the Indian Radio Company and the Indian Government with a view to the establishment of a wireless telephony service between India and Great Britain.

An official of the General Post Office informed *The Wireless World* that such a service would be operated in this country by the stations engaged in the transatlantic and Australian services,

THE 1930 PORTABLE.

Next week's issue of *The Wireless World* will be devoted to portable sets. The contents will include special articles on modern design, a review of representative types, hints and tips for the portable user, tests on portable accessories and a fully illustrated Buyers' Guide.

viz., the transmitter at Rugby and the receiver at Baldock. A further announcement may be expected in the near future.

o o o o

FREE SETS FOR THE BLIND.

The Secretary of the Croydon Voluntary Association for the Blind informs us that every blind person in the district is to be presented with a one-valve set. Funds for this purpose were obtained at a special Sunday performance recently given at the Davis Theatre, Croydon. This splendid result should encourage similar efforts in other districts.

o o o o

ANOTHER PARISIAN RADIO SKIRMISH.

Conflict seems inevitable in connection with the Paris Autumn Wireless Show. Last year two rival shows were held, one by the "official" manufacturers' association, and the other by independent firms; the arrangement was mutually destructive, however, and this year arrangements have

been made for an all-embracing international show under a single roof in the Boulevard Raspail. Our Paris correspondent now reports that warfare has been renewed, this time on the question of the alleged excessive rentals for the exhibition stands. It is possible that Parisians may again enjoy two shows.

o o o o

SET MAINTENANCE SCHEME.

The Radio Association invites the co-operation of reputable wireless traders in connection with a national scheme for the maintenance of listeners' sets. Applications for trade details should be addressed to the General Secretary, Radio Association, 22-23, Laurence Pountney Lane, London, E.C.4.

o o o o

PLEA FOR EMPIRE RADIO-TELEPHONY.

One of the most interesting declarations at the 12th Congress of Empire Chambers of Commerce now in session at the Guildhall, London, is that of the Bermuda Chamber, which has expressed its desire that the Imperial Government should recognise the importance of establishing a wireless telephony service throughout the Empire with the least possible delay.

o o o o

FRENCH BROADCASTING BOOM?

A radio boom in France is considered likely in the near future, for the paradoxical reason that the much-discussed broadcasting Bill has again been temporarily shelved by the House of Deputies. Faced with another long period without legislation, radio concerns are hoping that official consent will be given for immediate broadcasting improvements.

We understand that Radio Toulouse hopes shortly to increase its power from 8 to 60 kW., while the town of Lille aspires to an entirely new station. Nice (Juan-les-Pins) wishes for a power increase to 5 kW.

o o o o

HIGH PERMEABILITY ALLOYS.

It is regretted that an error occurred in Fig. 4, p. 540, of our issue of May 21st, in the article bearing the above title. The letters H and I should be interchanged in the two respective positions in which they appear.

o o o o

CANADA'S WIRELESS POLICE.

A private code and secret wavelength are to be used by the Ontario Provincial Police on their wireless network, which will be put into service this month. District police stations all over Ontario are to be linked up by wireless with the headquarters in Toronto.

The Loud-Speaker Diaphragm

The Radial Velocity of Sound in a Conical Diaphragm.¹

By N. W. McLACHLAN, D.Sc., M.I.E.E., F.Inst.P.

IN a former article² we saw that loud speaker diaphragms exhibit the phenomenon of breaking up. The fundamental break-up frequency for conical diaphragms 8in. or more in diameter, driven centrally by a reed, occurs below the middle of the pianoforte. The first major mode corresponds to an almost fixed centre, the amplitude increasing with the radius. Minor modes appear below this, due to asymmetry, non-homogeneity, and lateral motion of the reed. Higher modes include radial or circular nodes or a mixture of the two.

Suppose we consider the propagation of energy from the centre of the diaphragm outwards, and assume the diaphragm to be symmetrical, the material of which it is composed to be isotropic (equal mechanical properties in every direction), and the drive axial. When the energy reaches the periphery of the diaphragm it has nowhere to go, and therefore returns to the centre. This can be regarded as the reflected wave, which combines with the direct wave from the centre to produce the peculiar dust figures. In view of the complete symmetry of the diaphragm (absence of the usual joint assumed) it is difficult to see why the dust figures should be anything but concentric circles. That is to say, in a perfect system the nodal lines should be circles. Moreover, it is some asymmetry or lack of homogeneity of

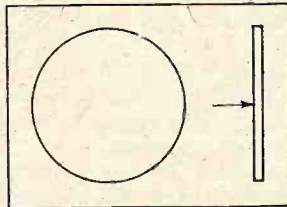

Fig. 1.—Disc driven centrally by alternating force.

the diaphragm which causes the radial nodes to appear. Although the diaphragm used for the experiments had been damaged, there are always radial nodes on an undamaged diaphragm. For a similar reason there are radial nodes in a telephone or other flat diaphragm. Furthermore, where a flat steel or other metal diaphragm is concerned, it is possible to calculate the frequencies at which the various modes of vibration occur.

The "modes" commence at comparatively low frequencies owing to the low velocity of propagation of energy down the diaphragm. To consider the problem of velocity down a diaphragm it is well to start with the simple case of a flat circular disc. In Fig. 1 we have a disc driven at the centre by an alternating force* of any suitable frequency. Let us assume that the velocity with which energy travels from the centre towards the periphery is constant at all radii. Taking the velocity as 250ft. per second, and the radius of the disc as

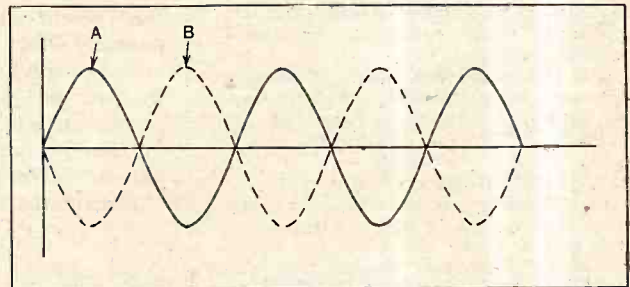

Fig. 3.—When the frequency is 250 cycles per second, A represents the motion of centre of disc and B that of the rim.

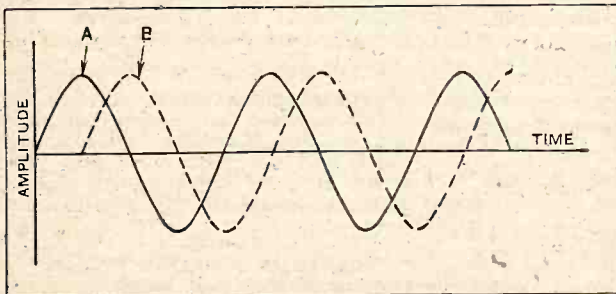

Fig. 2.—Showing at A the motion of centre of disc and at B the motion of the circumference.

6in., the time taken for the effect at the centre to reach the circumference is $1/500$ th of a second. This means that when anything happens at the centre it is felt at the circumference $1/500$ th second later. The state of affairs is portrayed in Fig. 2. Curve A represents the motion of the centre of the disc, whilst curve B represents the periphery. The time interval between the two curves is $1/500$ th second. Now, suppose the frequency of the applied force is 250 cycles per second, and again draw the curves A and B in their proper places. The time interval is $1/500$ th second, and this corresponds to half a cycle of the force. Moreover, the new condition is indicated in Fig. 3. Curves A and B are opposite to one another, which, being interpreted, means that the centre and the periphery move

¹ MS. first received by the Editor, December, 1928, and finally revised by author, April, 1930.

² *The Wireless World*, July 17th, 1929.

The Loud-speaker Diaphragm.—

in different directions at any particular instant. In Fig. 4 the outer part of the disc moves outwards, whilst the inner part moves inwards, and vice versa.

We have tacitly made several assumptions in the preceding investigation which are justifiable from the viewpoint of simplicity. But these simplifications do not pertain to practice. To avoid radial nodes we have assumed the disc to be isotropic and perfectly symmetrical and the drive to be purely axial. Also we have taken the velocity of propagation from the centre outwards to be constant. This may require an explanation, which is given below.

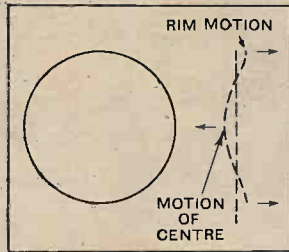

Fig. 4.—Showing bending of circular disc due to low velocity of propagation.

Velocity in a Straight Bar.

When a blow is delivered on the end of a long steel bar the energy travels down the bar at a definite and constant rate whatever the size of the bar. This is the velocity of "sound" in the bar, and is about 5.3×10^5 cm. per second, or about 16 times the velocity of sound in air. The energy travels along to the other end and is reflected backwards to the beginning, and so on. The net result is that the bar vibrates longitudinally and yields a sound corresponding to one or more of its natural frequencies. There is a definite relationship between the velocity of sound down the bar, the length of the bar and its natural frequency. As a parallel case, take an earthed aerial consisting of a single vertical wire. Its wavelength is approximately four times its natural length as illustrated in Figs. 5 and 6. Its natural frequency of electrical oscillation is found from the formula $v = \lambda f$, or $f = \frac{\text{velocity of light}}{4 \text{ length of aerial}}$.

Similarly, if our steel bar is firmly clamped at one end its natural frequency is found approximately from

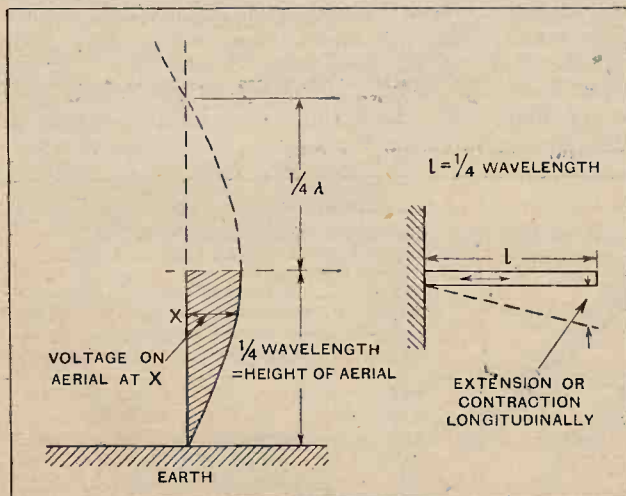

Fig. 5.—Illustrating the natural frequency of a vertical wire aerial.

B 19

the formula $f = \frac{\text{velocity of sound in steel}}{4 \text{ length of steel bar}}$. Now, where

our thin disc is concerned, the energy starts from a point (the centre) and spreads out, not like a sound-wave, which merely compresses and rarefies the material, but in a manner which causes bending of the disc. Clearly a small disc is more rigid than a large one, and were the steel disc large enough it would be easy to make it bend by pressing on the periphery. As another illustration of this we know that the natural frequency of a thin disc is lower than that of a thick disc. Moreover, as we pass away from the centre of the disc to the periphery the rigidity or stiffness gradually decreases. Owing to the reduction in rigidity with increase in radius the velocity of propagation of energy down the disc varies. We know from experience that when a metal rod and a wooden rod of identical dimensions are struck with a hammer the sound from the metal rod has a higher pitch. This means that the rate of vibration of the metal rod is greater, and is due to the energy travelling along it more rapidly than it

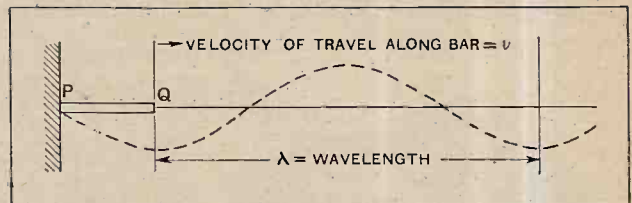

Fig. 6.—Illustrating derivation of formula for calculating the velocity of propagation along a metal bar when it is vibrating longitudinally without bending. In one cycle, the disturbance travels from P to Q and Q to P twice. The frequency \times wavelength equals the distance travelled per second, which equals velocity or $v = \lambda f$.

does along the wooden rod. Although the velocity of propagation in this case is in a different category from that of a disc, the experiment shows clearly that the metal rod is the more rigid of the two. The rigidity to sound waves can be measured by finding the force to stretch a bar of given dimensions, whilst the rigidity of bending can be found in a similar manner. This aspect of the situation is, however, beyond our present purview, and we must be content with the statement that the conditions during energy transmission down a disc cause bending (which, of course, is invisible to the naked eye), whilst transmission along a rod causes compression and extension. In the latter case the velocity of propagation depends merely upon the mechanical properties of the material, and is not concerned with its cross-sectional dimensions. On the other hand, where bending is introduced, the restitution exercised by a disc increases with its thickness. The pitch of the first natural frequency and also the velocity of propagation increases with the thickness. Here the term thickness is merely equivalent to saying "stiffness," since by using a material of equal density, but greater inherent mechanical strength, the frequency of a thin disc could be made equal to that of a thick one.

We saw above that the stiffness of a disc decreased as the radius increased. Thus the velocity of propagation will decrease also as the wave travels outwards from the centre.

The Loud-speaker Diaphragm.—

Where loud-speaker diaphragms are concerned, we are most familiar with a conical shape. By pressing the cone at different radii it will be noticed that the stiffness varies. At the apex the stiffness is large, whereas at the periphery it is small. Obviously the central stiffness of a 6in. cone is sensibly equal to that of a 14in. cone, but the peripheral stiffness of the former exceeds that of the latter.

Measurement of Radial Velocity in "Kone."

In order to obtain data relating to the velocity of propagation in a conical diaphragm, measurements were made during the course of experiments on dust figures. A series of rings was traced by lycopodium powder between a circle about 4in. radius from the centre and the periphery (see Fig. 7). The rings represent nodes, and the distance between two consecutive rings is half a wavelength. Knowing the frequency, the velocity is found from the expression cited previously, i.e., velocity = wavelength × frequency.

In Table I there is a series of values of the nodal distances at various frequencies. The distance between

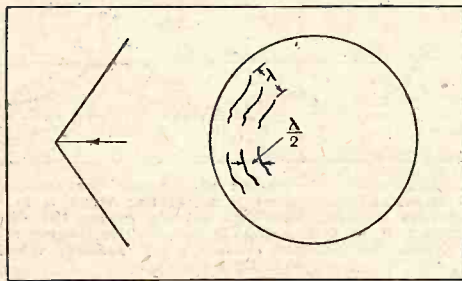

Fig. 7.—Illustrating nodal rings on "kone" diaphragm. λ = wavelength of propagation at outer part of diaphragm.

the rings at any given frequency was not quite constant, but a mean value has been taken. By aid of the preceding formula, the velocity of propagation along the outer part of the diaphragm is calculated. Near the apex it is doubtless greater than the figures given in Table I. At 1,600 cycles the nodal circles are accompanied by radial nodes, and the mean distance between two consecutive circles is 2.2 cm. This is the half-wave length, so that the whole wavelength = 4.4 cm., and the velocity of propagation is $1,600 \times 4.4 = 7,040$ cm. per second, or 23ft. per second. The velocity of sound at

20° Centigrade is about 1,200ft. per second. Thus the velocity of flexural waves down the outer part of the diaphragm at a frequency of 1,600 cycles per second is about one-fifth the velocity of sound in air. This leads to a very important result, which can be explained by the aid of Fig. 8.

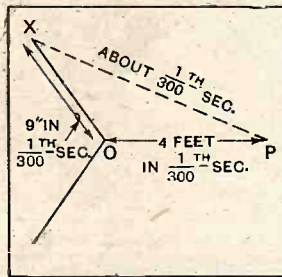

Fig. 8.—The sound from O will reach P at the same time as the wave in the diaphragm reaches X. Thus X moves 1/300th second behind O, so that the sound from X will be 1/300th second late at P.

The time taken for sound to arrive at P, due to vibration of the apex of the cone, is the same as that for the flexural wave to reach the periphery of the cone ($f=1,600$). Moreover, the sound from the periphery will reach P about $\frac{4}{1,200} = 1/300$ th sec. later than that from the apex. When f is 1,600 cycles per second, $1/300$ th second is equivalent to $\frac{1,600}{300} = 5.33$ cycles.

Thus the sound from the periphery will be 5.33 cycles late. Sound from areas lying between the apex and the periphery will be late by amounts varying from 0 to 5.33 cycles.

TABLE I.

Showing wavelength and velocity of propagation in outer part of "kone" diaphragm at various frequencies. Vel. of sound in air = 3.4×10^4 cm. per sec.

Frequency ~ per sec.	Mean distance between nodal circles. (cm.)	Wavelength on diaphragm. (cm.)	Velocity in diaphragm. (cm. per sec.)
1,600	2.2	4.4	7.0×10^3
2,000	1.9	3.8	7.6×10^3
2,900	1.5	3.0	8.7×10^3

Measurements have also been made on flat aluminium and steel discs, which are easier to handle than conical diaphragms. Here the nodes are traced by sand. Data for these are given in Tables II and III. In all three cases the velocity increases as the square root of the frequency, which confirms a formula by A. G. Warren.

TABLE II.

Aluminium disc. Radius 10 cm., thickness 0.165 cm.

Frequency ~	Radii of nodes. (cm.)	Mean radial velocity between consecutive nodes. (cm. per sec.)	
		Experiment.	Calculation.*
1,610	3.75	1.45×10^4	1.61×10^4
	8.25		
3,820	1.97	2.7×10^4	2.51×10^4
	5.5		
	8.75	2.5×10^4	2.51×10^4

TABLE III.

Tinned Iron Disc. Radius 9.4 cm., thickness 0.058 cm.

Frequency ~	Radii of nodes. (cm.)	Mean radial velocity between consecutive nodes. (cm. per sec.)	
		Experiment.	Calculation.*
970	4.16	6.6×10^3	7.4×10^3
	7.56		
1,600	2.33	8.9×10^3	9.5×10^3
	5.1		
	7.8	8.6×10^3	9.5×10^3

* A. G. Warren, M.Sc.

Wireless World
Laboratory Tests



on New Apparatus

"ENIWAIR" ADAPTOR.

This device has been evolved to facilitate the connection of a mains-driven set, or battery eliminator, to the supply mains in cases where a separate light point is not available for this purpose. The lamp is removed from its pendant and the special adaptor inserted; the lamp is then fitted in the holder on the adaptor. A three-core flex cable connects the adaptor to a control unit consisting of a four-position switch and a standard-type two-pin wall socket.

The eliminator, or set, is connected to the extra point. In general, the supply cables fitted to mains sets and eliminators terminate in a lamp adaptor. This can be replaced by a standard-type two-pin plug, but should the user not feel disposed to make this change, the small conversion unit supplied can be used and the adaptor fitted to the lamp-holder mounted on the two-pin plug.

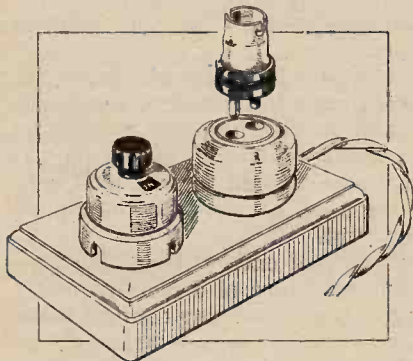

"Eniwaire" adaptor, which provides an extra point for attachment of a mains set or battery eliminator.

The four-position switch performs the following functions: switches on the light without the eliminator or set; enables the set, or eliminator, to be used, but with the light out; brings both into operation at the same time, or switches off both lamp and set. The wall switch, which hitherto controlled the light, may be left permanently in the "on" position, but it should be switched off if at any time the pendant is handled, as this will always be "live."

The device is supplied by P. M. Braidwood, Lyonsdown Road, New Barnet, and the price is 12s. 6d.

"EELEX" TESTING PRODS.

Tracing faults in a wireless receiver is a very instructive pastime, but unless more than usual care is exercised it can be also destructive. More often than not this process involves methodical point-to-point tests which necessitates delving into the

A Review of the Latest
Products of the
Manufacturers.

intricacies of the wiring to pick-up contact. In many cases this must be carried out with the batteries connected and the set switched on. To facilitate this work and at the same time prevent any possibility of damage accruing to the valves or other components, Messrs. J. J. Eastick and Sons, Eelex House, 118, Bunhill Row, London, E.C.1, have produced some special spring-loaded testing prods which are completely insulated and thus assure that short-circuits cannot possibly arise when delving into the wiring of the set. They consist of hollow tubes, somewhat resembling the popular type of vest pocket pencil, enclosing a thin brass rod. Normally this does not protrude beyond the tapered ends of the sleeve, but on applying a slight pressure the barrel slides back and reveals the pointed tip of the brass stem which contacts with the terminal, tag or wire, as the case may be.

Connection to the centre stem is made by passing a flex lead through a small hole in the side of the cap and fixing in position by tightening a concealed grub screw, which is reached by inserting a small screw-driver into the insulated hole in the top of the cap. These prods are available in black and red to distinguish positive and negative leads, as in most cases an ex-



"Eelex" spring-loaded testing prods afford a safe means of testing a set under working conditions.

ternal meter will be employed. They cost 3s. 6d. per pair, and should make a useful addition to the experimenter's tool kit.

"PILOT" L.F. TRANSFORMERS.

These transformers, which are of American origin, are marketed in this country by Messrs. Thos. A. Rowley, Ltd., 59, Skinner Lane, Birmingham, and can be obtained in two ratios, viz., 2:1 and 3½ to 1. The sample sent in for test has a ratio of 3½ to 1, and is housed in a black crystalline-finished metal case, the terminals being mounted on two small pieces of insulating material let in flush with the case and on opposite sides. Their small stature—they measure 2¾ in. only in height—renders them particularly suitable for mounting on the underside of a sub-baseboard such as is to be found in portable and transportable sets.



Pilot 3½:1 ratio L.F. transformer in metal case.

The measured D.C. resistance of the primary is 650 ohms, and the inductance, when carrying small values of D.C., was found to be 39.3 henrys with 2mA.; 30.2 henrys, with 4 mA.; and 26.5 henrys, with 6 mA. Without D.C. flowing, the primary inductance is of the order of 46.3 henrys. These measurements were made at a frequency of 50 cycles per second.

From these results it will be seen that the 3½ to 1 ratio model is most suitably employed either immediately after a leaky grid detector valve or in the anode circuit of a low-impedance L.F. amplifying valve. A practical test showed that the amplification obtained, when preceded by a valve of about 10,000 ohms A.C. resistance, was fairly constant over the audible scale, there being no noticeable resonances. Speech was clear and crisp, and orchestral music was well balanced, the high tones, as well as the bass, being in evidence.

The price of these transformers is 9s. 6d. each in either ratio.

WIRELESS
THEORY

SIMPLIFIED

By S. O. PEARSON,
B.Sc., A.M.I.E.E.

Part XXXII.—High Frequency Resistance of Conductors.

(Continued from page 564 of previous issue).

RESISTANCE, inductance, and capacity are usually referred to as the three *constants* of the electric circuit, but the term "constant" can really be applied only when the voltage and current in the circuit are also constant, that is to say, when a steady direct current is passed through it. In this section it will be explained why the resistance of circuit is usually greater when an alternating current is flowing than when a direct current is passed through the same circuit.

In Part I of this series, resistance was defined as the opposition offered by a conductor to the passage of a current through it, the value of the resistance in ohms being obtained by dividing the voltage between the ends of the conductor by the current in it. At a later stage, in dealing with alternating current circuits possessing inductance or capacity, or both, besides resistance, the ratio of voltage to current did not give the resistance at all, but the *impedance* of the circuit in ohms. Impedance is the opposition to the passage of an alternating current due to the combined effects of resistance and reactance, and one of the fundamental differences between resistance and reactance is that the former results in the generation of heat in the circuit, whereas the latter accounts for no consumption of energy whatever.

Resistance to Alternating and Direct Currents.

When it is stated that the A.C. resistance of a circuit is greater than its D.C. resistance, it must not be understood that a comparison is being made between resistance and impedance in the case of an inductive circuit. Quite irrespective of the value of the inductance, it is an increase of actual resistance which takes place, so that if, say, one ampere of alternating current is passed through the circuit, more power will be consumed than if one ampere of direct current is passed.

In general engineering practice, resistance is conceived as that property of a circuit by virtue of which heat is generated in the conductors themselves when a current flows. The rate at which electrical energy is being converted into heat in any circuit without branches is given by $P = I^2R$ watts, where I is the effective value of the current in amperes and R the resistance in ohms. This expression applies equally well to both A.C. and D.C. circuits, and is therefore, in a general sense, much more suitable for the calculation of resistance than Ohm's law,

which can be applied only to an A.C. circuit under very special conditions. Thus, when we know that the whole of the energy going into a circuit is being converted into heat in the conductors we have

$$R = \frac{P}{I^2} \text{ ohms}$$

where P is the power consumed in watts. The actual resistance of any part of a circuit is given by dividing the power representing the generation of heat in that part by the square of the current. Any power that is being converted into a changed form other than generation of heat, such as mechanical power, does not represent resistance in the true sense.

In high-frequency coils and tuned circuits, however, any kind of energy consumption represents a loss and leads to inefficiency; and so when we talk of high-frequency resistance we are usually referring to that equivalent resistance which would account for the total consumption of energy, due to all causes, when multiplied by the square of the current.

There are several sources of energy dissipation contributing to the effective resistance of a high-frequency circuit, the most important of them being (a) heat losses in the conductors themselves due to their actual or so-called "ohmic" resistance; (b) losses transferred to neighbouring closed circuits through the medium of mutual induction; (c) losses in the insulating materials necessarily used in conjunction with the circuit (dielectric losses); (d) energy radiated into space in the form of electromagnetic ether waves; (e) if any iron or other magnetic material comes within the influence of the magnetic field of the circuit, hysteresis losses will occur.

The relative importance of each of these factors depends on the nature of the circuit and to a very marked extent upon the frequency. These sources of loss will be considered separately in the order mentioned.

Resistivity and Conductor Resistance.

The actual resistance offered by a conductor to a direct current depends on the dimensions of the conductor and the material of which it is made, and to a certain extent on the temperature. It is always assumed that conductors are made of high-conductivity copper, unless otherwise stated, and the power lost in heating the conductor is for this reason usually referred to as "copper loss."

Wireless Theory Simplified.—

The conducting properties of a material are determined by its *specific resistance* or *resistivity*. This is the resistance offered by a centimetre cube of the material to a steady direct current passed between two opposite faces, the current being uniformly distributed within the cube. Of course it would not be practical to make measurements on an actual cube; the resistance is therefore measured for a conductor of considerable length and of uniform cross-sectional area, the resistivity being then calculated. The resistance of a conductor is proportional to its length and inversely proportional to its cross-sectional area, i.e., to the area of a section of the conductor obtained by cutting it through at right angles

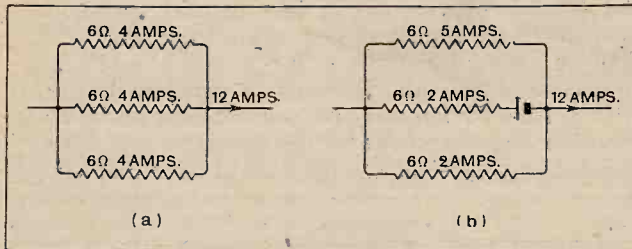

Fig. 1.—Although the circuits (a) and (b) have the same resistance in each branch and both circuits pass the same current, the power absorbed in generating heat in (a) is 288 watts, whereas in (b) it is 324 watts. The inference is that the effective resistance is a minimum when the currents are uniformly distributed.

to its length. Thus, if ρ denotes the resistivity of the material in ohms per centimetre cube at a given temperature, and R the resistance, at the same temperature, of a conductor made from it, these two quantities are connected by the formula

$$R = \rho \frac{l}{a} \text{ ohms,}$$

where l is the length in centimetres and a the area of cross-section in square centimetres. For a round wire of d cms. diameter the area of section is $\frac{\pi d^2}{4}$ sq. cms.,

$$\text{so that } R = \frac{4\rho l}{\pi d^2} \text{ ohms.}$$

For copper the resistivity is about 1.58×10^{-6} ohm per cm. cube at 0° centigrade, and 1.68×10^{-6} at an average working temperature of 15° C. The resistance of a copper conductor increases by 0.428 per cent. for each degree centigrade rise of temperature above zero.

Skin Effect.

The above formula for the calculation of resistance is based on the assumption that the current is uniformly distributed within the conductor—that is to say, that the *current density* in amperes per square centimetre is the same at every part of a sectional area. This is true for direct current, and very nearly true for alternating current of low frequency in thin conductors. But when a high-frequency current is passed through a straight, solid conductor of moderate diameter, the distribution is no longer uniform, for reasons to be explained. It is found that the central part of the conductor carries a relatively small proportion of the total current, the greater proportion flowing near the surface. With very high frequencies this effect may be so pronounced that

practically the whole of the current is concentrated in a thin layer at the surface of the conductor, the internal portions carrying only a negligible fraction. This tendency for an alternating current to be concentrated in a thin superficial layer, or “skin,” at the surface of a conductor, is referred to as *skin effect*.

Numerical Illustration.

As a result of skin effect the resistance of the conductor is increased compared with the D.C. value obtained with uniformly distributed current; it can be shown that the rate at which heat is generated in a conductor with a given value of current is least when the current is evenly distributed. This fact will be more easily appreciated if the solid conductor is imagined to consist of a large number of very thin parallel wires of equal size insulated from each other except at the ends, so that they represent a number of equal resistances in parallel. With D.C. each element would carry the same current, but with A.C. those near the centre of the bunch would carry less current than those near the outside, with the result that *more power would be consumed* for a given value of current, indicating higher effective resistance.

The principle involved here applies to any number of equal resistances in parallel, and therefore as a numerical illustration let us consider three equal 6-ohm resistances connected as shown in Fig. 1 (a).

Suppose that a steady current of 12 amperes is passed through the circuit so that 4 amperes flow through each resistance, the power expended in each being therefore $4^2 \times 6 = 96$ watts, the total power being $3 \times 96 = 288$ watts. The effective resistance of the circuit is thus

$$R = \frac{P}{I^2} = \frac{288}{12^2} = 2 \text{ ohms.}$$

Now, suppose that for some reason, such as the presence of a back E.M.F., the current in the middle resistance is reduced to 2 amperes and that the current in each of the other two is increased to 5 amperes, so that the total current passing is 12 amperes, as before. The new conditions are shown in Fig. 1 (b). The power expended in generating heat in the centre resistance is

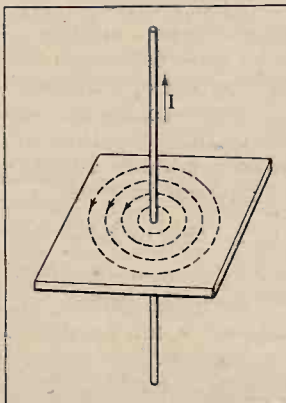

Fig. 2.—The field produced by a current in a long, straight conductor is one whose lines of force are circles surrounding the conductor. The field strength d cms. from the centre of the wire and outside it is $H = \frac{2I}{10d}$ gauss, I being in amperes.

now $2^2 \times 6 = 24$ watts, and that in each of the others $5^2 \times 6 = 150$ watts. The total power is therefore $150 + 150 + 24 = 324$ watts, and the effective resistance of the circuit as a whole, obtained by dividing this power by the square of the current, is $\frac{324}{12^2} = 2.25$ ohms, being 12.5 per cent. higher than for even distribution of currents.

Wireless Theory Simplified.—

The Cause of Skin Effect.

The phenomena which occur in a single conductor carrying a high-frequency current are in many respects similar to those illustrated by the circuit of Fig. 1 (b), but are very much more complicated. When a current is passed through a long, straight conductor a magnetic field is built up around it, each line of force being a circle, as shown in Fig. 2, which represents a straight conductor passing perpendicularly through a plane surface. This means that even a straight conductor possesses inductance and that therefore an E.M.F. will be induced in it whenever the current is changing; when an alternating current is passed through the conductor, alternating electromotive forces of the same frequency will be induced in it.

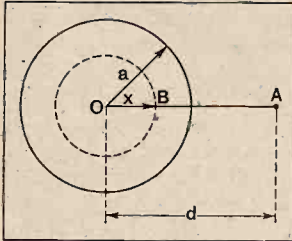

Fig. 3.—Enlarged section of a round conductor of radius a cms. The field strength at A is due to the whole of the current, but at B it is due only to that portion within the smaller circle.

are present, but because they are unevenly distributed, and, on the average, act in such a direction as to restrict the flow of current near the centre more than at the surface, thus increasing the current density at the surface at the expense of the inner parts of the conductor.

The reason for this effect becomes evident when we consider the disposition of the magnetic field relatively to the conductor when a current is passed through it. Let us assume that a steady direct current of 1 ampere is flowing through a long, round copper conductor, an enlarged section of which is shown in Fig. 3. Then at any point A outside the conductor at a distance d centimetres from its centre, the field strength is given by $H = \frac{2I}{10d}$ gauss or lines per sq. cm. Thus outside the conductor the field strength is inversely proportional to the distance from the centre, and the total number of lines of force surrounding the conductor can be quite easily calculated for each centimetre length.

Now consider a point B inside the conductor. It will be realised that a magnetic field exists even within the material of the conductor when the current is evenly distributed within it. But at the point B the field strength is due only to the current in that part of the conductor which lies within the dotted circle (Fig. 3), with OB as radius. The current in the part of the conductor outside this circle has no magnetic effect inside it. (A tube carrying a uniform current has no internal magnetic field.)

Let x be the radius of the dotted circle and a the radius of the conductor. Then, since the area of a circle is proportional to the square of its radius, the current flowing inside the dotted circle will be $I' = I \times \frac{x^2}{a^2}$ amps. and the field strength at B will be $H = \frac{2I'}{10x} = \frac{2Ix}{10a^2}$.

Thus inside the conductor the field strength is directly proportional to the distance from the centre, whereas outside it is inversely proportional.

In Fig. 4 the values of field strength or flux density are plotted for various distances from the centre of the conductor with uniformly distributed current. As we proceed from the centre outwards the field strength increases at a uniform rate until the surface of the conductor is reached, after which it begins to decrease again, rapidly at first, and then more gradually as it nears zero.

It will be noted from the curve that the flux density is greatest near the surface of the conductor. This fact might be used to explain the phenomenon of skin effect when the current is alternating, but it is rather simpler to look at the problem from another aspect, namely, to consider the total number of lines of force surrounding any part of the conductor per centimetre length.

If we consider the conductor to consist of a large number of equal thin filaments in parallel, it will be obvious from the foregoing remarks that any one of these filaments near the centre of the conductor will be surrounded by considerably more lines of force than one at

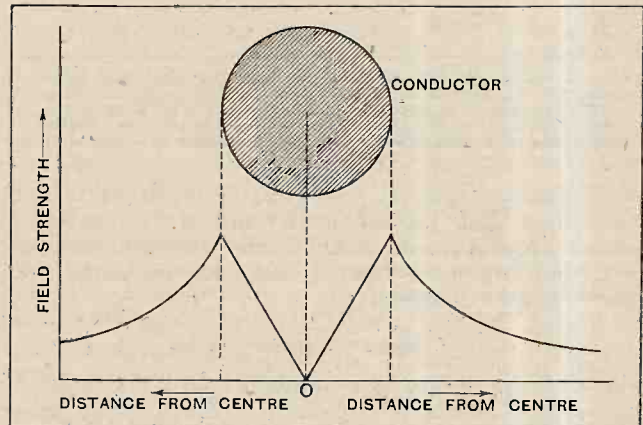

Fig. 4.—Diagram showing how the field strength varies with distance from the centre of a round conductor with uniformly distributed current. Inside the conductor the field strength is proportional and outside it is inversely proportional to the distance from the centre. Skin effect with A.C. is due to the presence of lines of force inside the conductor.

the surface. Now the inductance of a conductor is proportional to the number of lines of force surrounding it for a given value of current, and therefore it follows that the filaments near the centre have higher inductance than those at the surface. If, then, an alternating voltage is applied to the ends of the conductor, more current will flow near the surface where the reactive effects of inductance are less than at the centre.

The explanation of skin effect given here is necessarily only approximate; but the subject lends itself to exact mathematical treatment, and formulæ have been established for calculating the ratio of A.C. to D.C. resistance for round conductors of various diameters at different frequencies. Hence it is a very easy matter to determine the A.C. resistance of a more or less straight conductor at any desired frequency by reference to tables or a curve. However, when a conductor is wound into the form of a coil the normal conditions for skin effect are entirely upset and a new set of conditions created.

(To be continued.)

Microphones in St. Paul's Cathedral.

The famous Albert Hall echo is nothing to that which the "O.B." department are "up against" in St. Paul's Cathedral. Microphone tests are now being conducted to discover whether it is possible to broadcast from the Cathedral on Wednesday, June 25th, on the occasion of the Thanksgiving Service for the preservation of the building.

o o o o

An Innovation.

No microphone has ever before been permitted in St. Paul's, but, now that the Dean and Chapter have kindly given their consent to the innovation, it would be a thousand pities if technical difficulties proved too obstructive.

o o o o

Freaks of Echo.

It would be difficult to find another building in the world where sound plays such tricks as in St. Paul's Cathedral. The Whispering Gallery is famous, but there are other spots in the building where echoes create an uncanny effect. It is possible to sit within 30 yards of the preacher and hear nothing but a confused murmur, while farther down the nave every word will come through clearly.

o o o o

Great Days at Slaithwaite.

The inhabitants of Slaithwaite now spend their evenings in trips to Moorside Edge to observe the progress made with Northern Regional.

The main building, with the exception of the engine room, has now reached a height of 12ft., and progress is fairly rapid under the improved weather conditions. Barring accidents, it is hoped to have the building complete by the early autumn.

o o o o

Northern Regional Tests by December.

The apparatus will follow almost immediately, and it is probable that the first transmission tests will be made in December. I hear that work has just started on the foundations for the three 500ft. masts.

o o o o

The Scotsmen's Prayer.

Meanwhile a party of B.B.C. engineers is flying an 8ft. man-lifting kite at Falkirk, on the probable site for the Scottish Regional. This kite will support a fairly high aerial in a good wind, which may account for the rumour I heard last week.

The rumour says that Scotsmen are praying for perpetual gales, rendering masts unnecessary.

o o o o

Another Anti-oscillation Pamphlet.

Sweet reasonableness is the principle advocated in a new "Anti-oscillation" pamphlet now in preparation at Savoy Hill. Those who apply for it will be exhorted to approach their oscillating neighbour in a friendly spirit and to turn to the G.P.O. only as a last resort.

It is admitted that spasmodic oscillation is extremely hard to detect. On many occasions Post Office men have spent whole evenings in the homes of sufferers without hearing a twitter. Oscillation begins when they have gone.

B 25



By Our Special Correspondent.

What Mr. Adrian Boulton Will Not Do.

Those who hope that Mr. Adrian Boulton's arrival at Savoy Hill means a grand game of musical chairs and overturning of tables must prepare for disappointment. In an interview a few days ago Mr. Boulton told me that, as Director of B.B.C. Music, the last thing he intends to do is to interfere with the existing balance between grave and gay, classical and non-classical.

o o o o

Musical Experiments.

Changes there certainly will be, but they will be in the direction of improving the manner rather than the matter. Existing musical scores may be "cleaned up," to use Mr. Boulton's expressive phrase, to make them more digestible for the microphone.

o o o o

"Close-ups."

Experiments are also to be tried with musical "close-ups," in which the solo instrument is brought near to the microphone, with the remainder of the orchestra far in the background. This effect may be the basis for a unique musical technique peculiar to broadcasting.

o o o o

Repetition.

But the innovation which may well change the ordinary man's conception of broadcast music is Mr. Boulton's plan to introduce more repetition of "difficult" works. ("Help!" says a voice from the gallery.) Paradoxically, this should tend to brighten broadcasting. Unless one is in the habit of giving apparently un-

pleasant pieces a second hearing, it is impossible to imagine how much they gain in the process. Mr. Boulton aims at giving listeners the opportunity, and I believe that the ordinary man will eventually thank him.

o o o o

The New Chairman?

The Right Hon. J. H. Whitley, P.C., whose name has suddenly appeared among the "probables" for the post of B.B.C. Chairman, is a more likely successor to Lord Clarendon than any other of the suggested candidates. Mr. Whitley is one of those rare public figures with no political bias, and his experiences on committees and as Speaker in the House of Commons from 1921 to 1928 have given him that impartial outlook essential to anyone holding the reins at Savoy Hill.

o o o o

An Arrest at Savoy Hill.

The B.B.C.'s severer critics will be surprised to learn that the police had never visited Savoy Hill in an official capacity until Monday of last week. On that day two officers arrived and arrested an artist who had just been performing in a studio. For the comfort of other performers it is well to explain that the charge had no connection with the broadcast.

o o o o

Running Commentary on Cricket Match.

Mr. F. W. Elam, whose task it will be to give a running commentary to Northern listeners on the Lancashire and Yorkshire cricket match on Whit Monday, intends to enliven dull patches in the play with cricket stories and reminiscences. I hope he has plenty in store.

o o o o

The Process of Elimination.

A friend vouches for the truth of the following:—

A Northern retailer was recently approached by a customer who wanted to buy an eliminator. "How many valves?" was the retailer's first question. "Oh, it's a crystal set," was the reply. "I thought the eliminator did away with valves."

The retailer saw a good opportunity to sell an all-mains set. "I suppose your lighting supply is A.C.?" he asked. "No," came the answer, "it's gas!"

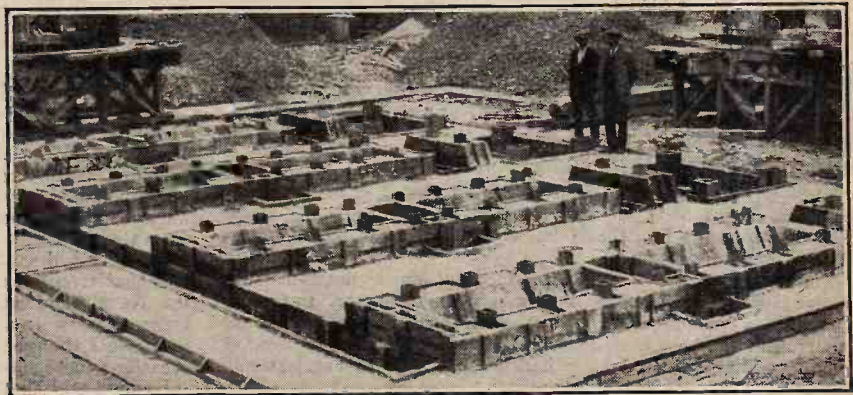

NORTHERN REGIONAL PROGRESS. This photograph, taken at Moorside Edge a few days ago, shows the 600-ton concrete bed which will carry the four 300 h.p. Diesel engines driving the D.C. generators. To avoid vibration effects the engine bed is surrounded by an air channel.

CORRESPONDENCE

The Editor does not hold himself responsible for the opinions of his correspondents.

Correspondence should be addressed to the Editor, "The Wireless World," Dorset House, Tudor Street, E.C.4, and must be accompanied by the writer's name and address.

SUNDAY'S PROGRAMME.

Sir,—The following is a typical Sunday programme as transmitted by Johannesburg (JB): 10.30-11 a.m., service from local church; 3.15-3.30 p.m., children's Sunday school; 3.30-5.30, gramophone records; first 30 to 45 minutes classical, remainder lighter music of good type interspersed with occasional vocal or instrumental solos by celebrated artists. These two hours of gramophone broadcasts are one of the week's bright features because the selection seems to be made by a musician who understands what the public wants. 7.30-8.45 p.m., relay from a local church; seven churches are given turn and turn about.

8.45-10 p.m., relay from Durban Municipal Orchestra conducted by Mr. Dan Godfrey (son of Sir Dan Godfrey), who, in some 12 months, has raised this orchestra from the mediocre stage to one of outstanding merit bearing favourable comparison with the best of English orchestras, such as London Symphony and Hallé, at Manchester.

Some other points may be noted. Licence fees are charged by "zones," according to distance from station, varying from 35s. locally down to 10s. at 250 miles, of which the post office takes 10 per cent. for collection. Considering that total licences in all South Africa are under 19,000, the broadcasting company puts over fair to good programmes. We are happily free from "educational" talks; those sent out are nearly all interesting, the length being usually 10 minutes, but never exceeding 15 minutes. Thursdays from 8.15 to 10 p.m. is a relay from Durban municipal orchestra of first-class symphony concerts. On many Monday nights we receive complete operas *via* gramophone records; wonderfully good was the most recent "La Bohème," in Italian, put over without a break except between the acts, and lasting 1 hour 40 minutes. T. LEWIS.

P.O. Box 1980, Johannesburg.

FADING AND DISTORTION.

Sir,—I should like to point out an error in the article entitled "The Fading and Distortion of Distant Signals." The writer states that the time required to scan the picture in the Baird Television apparatus is 0.8 seconds.

Then the time for 1 strip = $\frac{.08}{30} = .00266$.

A vertical displacement of 10 elements, therefore, corresponds to a lag of

$$\frac{.00266}{7} = .38 \text{ milliseconds.}$$

This result does not appear to allow such a simple explanation as is given in the article. Assuming the data to be true, perhaps Professor Appleton could explain. R. V. JONES.
Oxford.

BALSA WOOD DIAPHRAGM.

Sir,—It is not without some misgiving that I dare to answer so great an authority on loud speakers as Dr. McLachlan, and I hasten to assure him that I know nothing of the technicalities of loud speaker design.

The ultimate test of any reproducer of music must be subjective; scientific formulæ may assist the designer, but it is as a musical, not a scientific, instrument, that it must stand its trial. And it is as a musical instrument that the Balsa-wood piston speaker (which I have had the privilege to hear) stands above all others, in my opinion.

The highest frequencies, which are singularly free from unpleasant resonances, come through with a definition. I have never heard from a paper cone speaker; at last the piccolo is a piccolo. The bass, on the other hand, is clear and vigorous

without any of those woolly thuds of uncertain origin which characterise the paper cone. If the treble is slightly emphasised, it is certainly not at the expense of the bass; and, in any case, is it not much easier to compensate for this in the amplifier than for the reverse conditions?

Ealing, W.5.

D. E. L. HAYNES.

RADIO SERVICING.

Sir,—Your Editorial upon the above has raised a most pertinent question, affecting the public and radio trade alike, and it appears to me that the subject is considerably more complex than your article would convey.

"Service" is a very broad term, covering a multitude of objectives, and is required in a variety of ways. In some cases "service" is extended to mean an almost indefinite period of maintenance; since individual aptitude plays a decisive part in the degree of satisfaction the listener ultimately obtains from his receiver. Obviously, the period of tuition cannot be taken beyond an economic point, which will have some bearing upon the value of the installation. It seems that the public hardly appreciate the extent of its demands upon radio dealers, who are expected to be thoroughly conversant with any set now on the market, either factory-built or home-constructed.

Every reader of *The Wireless World* knows the enormous variety of products on the radio market to-day, and whilst the factory-built set has the advantage of conforming to type, the home-constructed counterpart rarely follows anything but the broadest principles of the original design. Most home-set builders construe very liberally not only the components to be used, but also the constructional details of a given receiver, and the local factotum is invited to diagnose a complaint often with unsuspected home-made complications.

It is admitted that radio-service calls for considerable knowledge of the science of wireless, and one which yearly increases as the industry develops. It is very doubtful if this is fully realised by that section of the public who flock to price-cutters' shops in an endeavour to "beat the band." Cut-price means cut service. Why be pushed to buy to your capacity because it's cheap? It's one thing to shovel the goods over the counter, but it takes a radio firm to service it afterwards. Pay the proper price, get the proper goods, and be certain of the fact that your dealer will be able to give you the proper service.

SHEARMAN DYER,

Vice-chairman,

Wireless Retailers' Association of Great Britain.
London, S.E.5.

EMPIRE BROADCASTING.

Sir,—I was interested to read the reports on the reception of G 5SW in Nairobi, as stated in items published under "Broadcast Brevities" in the March 26th number of *The Wireless World*.

Your Nairobi correspondent stated that G 5SW is almost inaudible in the evenings. I am, roughly, about 300 miles due north of Nairobi here, but have no difficulty in tuning in G 5SW from the commencement of the evening programme at 19.30 hours G.M.T. I will say, though, that there is an appreciable increase in signal strength after about 21.00 hours G.M.T. Referring to the Naval Conference speeches mentioned by your Nairobi listener, these were also received here at amazing strength, and at the time I thought that G 5SW was using extra power for the occasion; these speeches were received here early in the morning.

I would add that during the past five years I have resided in India, Persia and Burma, but from not one of these countries did I ever get good reception of G 5SW at any time of the day, although stations like PCJJ could always be received clearly.

British Somaliland.

J. DRUDGE-COATES.



READERS' PROBLEMS



"The Wireless World" Supplies a Free Service of Technical Information.

The Service is subject to the rules of the Department, which are printed below; these must be strictly enforced, in the interest of readers themselves. A selection of queries of general interest is dealt with below, in some cases at greater length than would be possible in a letter.

Fluctuating Selectivity.

Although I am only a few miles from Brookmans Park, my receiver is normally capable of separating the two transmissions quite well. Occasionally, however, selectivity seems to disappear almost entirely and one or other of the local stations spreads over the whole tuning scale. The set has been carefully tested for high-resistance connections, leakages, etc., but no fault can be found. Do you think that this most annoying effect is due to sudden changes in transmitting power?

P. D. F.

It seems almost certain that this is due to re-radiation from a near-by aerial—probably from that of your next-door neighbour. We expect that the "spreading" of the local transmission will be found to coincide with the switching-on of his set. The remedy is to move the two aerials as far apart as possible, and, if it can be managed, to arrange for them to be more or less at right angles throughout the greater part of their length. If both the receivers are at present earthed to the water mains, an improvement is likely to be effected by making a connection for one of them to a buried earth plate.

RULES.

- (1.) A query must be accompanied by a COUPON removed from the advertisement pages of the CURRENT ISSUE.
- (2.) Only one question (which must deal with a single specific point) can be answered. Letters must be concisely worded and headed "Information Department."
- (3.) Queries must be written on one side of the paper and diagrams drawn on a separate sheet. A self-addressed stamped envelope must be enclosed for postal reply.
- (4.) Designs or circuit diagrams for complete receivers or eliminators cannot ordinarily be given; under present-day conditions justice cannot be done to questions of this kind in the course of a letter.
- (5.) Practical wiring plans cannot be supplied or considered.
- (6.) Designs for components such as L.F. chokes, power transformers, complex coil assemblies, etc., cannot be supplied.
- (7.) Queries arising from the construction or operation of receivers must be confined to constructional sets described in "The Wireless World"; to standard manufactured receivers; or to "Kit" sets that have been reviewed.

B 27

The Superheterodyne Unit.

Would it be possible to use indirectly heated A.C. valves, fed with anode current from an eliminator, in the construction of the superheterodyne short-wave adaptor described in "The Wireless World" for April 23rd?

E. T. M.

We can hardly recommend this course, as any remaining vestige of hum will tend to modulate the oscillations generated in the unit: modulations produced in this way would be passed on to the second detector and L.F. amplifier.

"Safety Last" Filament Wiring.

On two occasions I have been unfortunate enough to burn out the valve filaments of my det.-L.F. set (circuit diagram enclosed) by making accidental contact between H.T. positive and the metal panel. I believe that this indicates that the filament circuit wiring is not in accordance with correct practice, and am told that it will not be altogether easy to obviate all possibilities of a recurrence of the trouble, because the L.T. on-off switch is mounted directly on the panel, and is not insulated from it. Will you please advise me?

E. S. D.

In your circuit diagram, of which the essential part is reproduced in Fig. 1A, you do not give any indication as to the electrical connections of the metal panel, but we expect that matters are arranged as indicated in our addition to your sketch, and that the pole of the switch which is joined to the filaments is in contact with the metal. If this is so it is not hard to see how an accidental connection between H.T. + and the screen will cause damage to the filaments; when the L.T. switch is "open" there is a path via the L.T. battery to one side of the parallel filaments, and the other side of the filaments is joined to the earthed panel. By making contact between H.T. + and "earth" the high-tension battery is applied directly across these filaments, with, as you have discovered, disastrous results.

The simplest way of ensuring immunity from accidents of this sort is indicated in Fig. 1B. The connections to the switch should be reversed, so that the insulated pole is joined to the filaments, while the

body of the switch, which is automatically in contact with the metal work, will be joined to L.T.+, H.T.-, and to the panel. Care must be taken to see that no other lead, except, if desired, an earthing

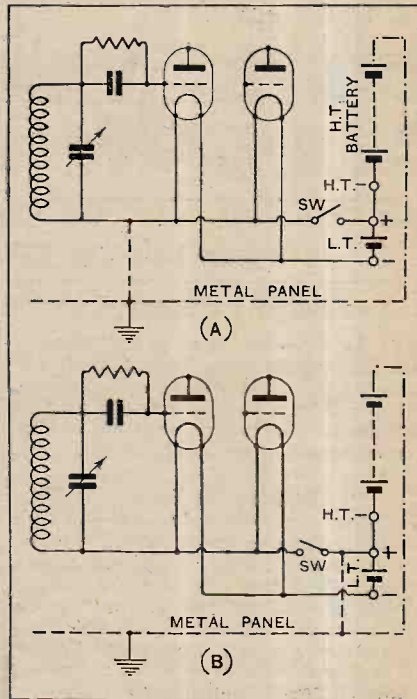

Fig. 1.—Diagram showing how valves may be burnt out when an "earthed" on-off switch is used, and (diagram B) how risk of damage through this cause is obviated by reversing leads. Short-circuit paths are shown by "dot-dash" lines.

wire, is brought to the metal panel. With this form of interconnection accidental contact between the H.T. battery and the screen will not affect the valves, although, of course, it will reduce the life of the battery itself.

In wiring filament circuits and in arranging for H.T.-L.T. interconnections it is well to work on the "safety first" principles adopted by contributors to this journal.

A Portable "Portable."

I propose to build up a small self-contained set on the lines of the "Everyman Portable" described in your issue of April 18th, 1928, but, if you approve, should like to introduce one or two modifications. It is intended to use a non-spillable accumulator cell for L.T. supply, and so the two valve filaments will be connected in parallel and not in series as in the original.

Secondly, I intend to dispense with long-wave reception. Will you please give me an amended circuit diagram showing the parts of the receiver affected by these modifications?

K. G. B.

Your proposed modifications are quite in order, and we give, as requested, an amended diagram (Fig. 2). For the sake of completeness we have shown the whole receiver circuit.

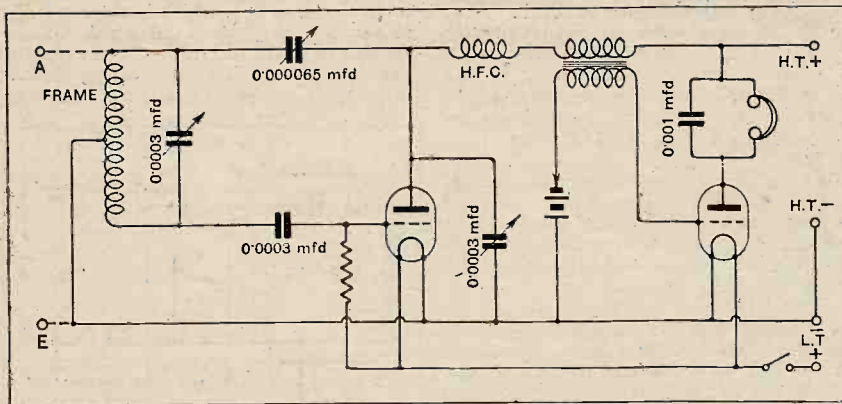

Fig. 2.—Circuit diagram for a compact det-L.F. portable set.

As the filaments are to be connected in series it will no longer be possible to obtain "free" grid bias for the output valve, and so a battery must be used as indicated. For headphone work one or two cells will, of course, be ample.

o o o o

Volts on the Plate.

Will you please tell me how to estimate the voltage actually applied to the anode of a valve? I am particularly concerned with my detector, which has in series with its plate a coupling-resistance of 80,000 ohms, and a feed resistance of 20,000 ohms. H.T. current is derived from a D.C. eliminator (220-volt mains), and I believe that about 20 volts is lost in the smoothing circuits.—S. B. C.

Before you can calculate the voltage actually applied to the anode, you must know the current passing through the circuit: as this circuit includes the valve, of which the resistance cannot readily be estimated, a measurement will be necessary. The voltage absorbed in the external load is then ascertained by multiplying its total value in ohms (in your case, $80,000 + 20,000 = 100,000$ ohms) by the current passing, expressed as a fraction of an amp.

By subtracting the voltage dissipated across the external resistance from the total applied to the circuit, you will be

able to ascertain the voltage existing between the plate and filament of the valve itself.

o o o o

Short-circuiting the H.F. Component.

I have found that in cases where instability is traced to the action of H.F. currents in the anode circuit of the detector valve, a by-pass condenser of 0.002 mfd., or even more, will generally effect a cure. This extra capacity is, of course, connected between plate and filament of the detector, and seems to be much more effective than a condenser of from 0.0001 to 0.0005 mfd., which is usually recommended in this position. Is there any objection to using a capacity of the order mentioned?

V. R. R.

It is quite understandable that a large anode-filament capacity should be more effective as an H.F. by-pass than the size

of the condenser usually specified; but it must be remembered that this is one of the many occasions where a compromise must be effected. If the condenser is too big the characteristics of the succeeding L.F. amplifier will be seriously affected—generally in the direction of a serious loss of high notes.

o o o o

A Common H.T. Feed.

I have an H.T. accumulator battery giving 180 volts, and in the design of my new receiver am undecided whether to provide tappings for the anode supply of those valves requiring less than the maximum voltage, or to fit voltage-absorbing resistance where necessary. A word of advice on this subject would be welcome.

I take it that it is desirable that all the cells should be discharged more or less equally.

S. F. F.

If you do not object to the slight extra cost entailed by fitting feed resistances in the various anode circuits, we think there can be no doubt that this is the best course; although an accumulator H.T. battery has a low internal resistance as compared with dry cells, it is quite possible that there may be sufficient resistance to have a prejudicial effect on quality of reproduction, which can be guarded against by fitting these resistances, in conjunction, of course, with by-pass condensers.

Condenser Noises.

I have attempted to modify my det.-L.F. set for ultra-short-wave reception, and have met with a fair measure of success, except for trouble with the tuning condenser. Rotation of its dial through about half its travel produces harsh, grating sounds in the phones, and renders impossible any successful reception of this part of the tuning scale. Can you tell me what to do to put matters right?

A. L. J.

It is possible that your condenser is of a type intended purely for reception on the normal wavelengths, and that no particular precautions are taken to ensure perfectly constant electrical connection to the rotor. Probably you will be able to improve matters by fitting a pigtail connector of flexible wire between the rotating spindle and the terminal which is joined to the rotor. This, of course, will be supplementary to the existing connection.

Balsa Wood.

I was interested in the description of a loud speaker with a Balsa wood diaphragm which appeared in your issue of April 9th, and should like to try some experiments with this material. Can you tell me where it can be obtained?

D. C. W.

We suggest that you should apply to the Balsa Wood Company, Ltd., 4, Great Queen Street, London, W.C.2.

FOREIGN BROADCAST GUIDE.**SAN SEBASTIAN (EAJ 8)**
(Spain).

Geographical Position: 1° 59' W. 43° 21' N.
Approximate air line from London: 570 miles.

Wavelength: 459 m. Frequency: 653 kc.
Power: 0.5 kW.

Time*: Greenwich Mean Time.

* Spain has not adopted B.S.T. this year.

Standard Daily Transmissions.

Main evening programme: 21.00 or 22.00 B.S.T. until midnight or 01.00. Frequent relays are made of operatic performances or concerts from Casino and public squares.

Male announcers. Call (Phonetic): *Ay-ah chota ocho oon-ee-own-ay Radio San Sebast-ee-yahn, instarl-ardour en ell montay Ee-geld-owe.*

Closes down with a peal of bells, followed by Spanish National Anthem and the words: *Buenas noches, Señores.*

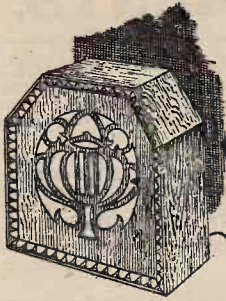

Everybody's calling for

Player's please



We Regret the Delay in deliveries of the R.G.D. Radiogramophone



during our removal to larger and more modern works, and beg to say that all orders can now be dealt with speedily from our new address.

The All Electric R.G.D. Radiogramophone for A.C. or D.C. mains with coil-driven speaker.

Mahogany Oak
£80 £75

We shall be pleased to supply literature on application.

The Radiogramophone Development Co.
72, MOOR STREET, BIRMINGHAM.



THE VERY LATEST IN VALVES!

LONG LIFE! VOLUME!
SENSITIVITY!

Colloidal Cathodes the secret!

The plating, with Colloidal deposits, of the incandescent cathode of the new Vatea Valve is the secret of its durability, sensitivity and volume. Amazing selectivity and incredibly improved reception are the direct result of this very latest achievement in valve design and filament construction. Replace your present valves with Vatea Valves and you will be amazed at the shortcomings of the old type.

H.F. and G.P
6/-
SUPER POWER 7/6
2 and 4 VOLTS.

VATEA

THE NEW VALVES

STYLE

ABBEY RADIO,
47, Victoria Street, London, S.W.1.
Telephone No. : Victoria 3914.

MISCELLANEOUS ADVERTISEMENTS.

NOTICES.

THE CHARGE FOR ADVERTISEMENTS in these columns is:

12 words or less, 2/- and 2d. for every additional word.

Each paragraph is charged separately and name and address must be counted.

SERIES DISCOUNTS are allowed to Trade Advertisers as follows on orders for consecutive insertions, provided a contract is placed in advance, and in the absence of fresh instructions the entire "copy" is repeated from the previous issue: 13 consecutive insertions 5%; 26 consecutive, 10%; 52 consecutive, 15%.

ADVERTISEMENTS for these columns are accepted up to FIRST POST on THURSDAY MORNING (previous to date of issue) at the Head Offices of "The Wireless World," Dorset House, Tudor Street, London, E.C.4, or on WEDNESDAY MORNING at the Branch Offices, 19, Hertford Street, Coventry; Guildhall Buildings, Navigation Street, Birmingham; 260, Deansgate, Manchester; 101, St. Vincent Street, Glasgow, G.2.

Advertisements that arrive too late for a particular issue will automatically be inserted in the following issue unless accompanied by instructions to the contrary. All advertisements in this section must be strictly prepaid.

The proprietors retain the right to refuse or withdraw advertisements at their discretion.

Postal Orders and Cheques sent in payment for advertisements should be made payable to **ILLIFFE & SONS Ltd., and crossed & Co.** Notes being untraceable if lost in transit should not be sent as remittances.

All letters relating to advertisements should quote the number which is printed at the end of each advertisement, and the date of the issue in which it appeared.

The proprietors are not responsible for clerical or printers' errors, although every care is taken to avoid mistakes.

NUMBERED ADDRESSES.

For the convenience of private advertisers, letters may be addressed to numbers at "The Wireless World" Office. When this is desired, the sum of 6d. to defray the cost of registration and to cover postage on replies must be added to the advertisement charge, which must include the words Box 000, c/o "The Wireless World." Only the number will appear in the advertisement. All replies should be addressed No. 000, c/o "The Wireless World," Dorset House, Tudor Street, London, E.C.4. Readers who reply to Box No. advertisements are warned against sending remittance through the post except in registered envelopes; in all such cases the use of the Deposit System is recommended, and the envelope should be clearly marked "Deposit Department."

DEPOSIT SYSTEM.

Readers who hesitate to send money to unknown persons may deal in perfect safety by availing themselves of our Deposit System. If the money be deposited with "The Wireless World," both parties are advised of its receipt.

The time allowed for decision is three days, counting from receipt of goods, after which period, if buyer decides not to retain goods, they must be returned to sender. If a sale is effected, buyer instructs us to remit amount to seller, but if not, seller instructs us to return amount to depositor. Carriage is paid by the buyer, but in the event of no sale, and subject to there being no different arrangement between buyer and seller, each pays carriage one way. The seller takes the risk of loss or damage in transit, for which we take no responsibility. For all transactions up to £10, a deposit fee of 1/- is charged; on transactions over £10 and under £50, the fee is 2/6; over £50, 5/-. All deposit matters are dealt with at Dorset House, Tudor Street, London, E.C.4, and cheques and money orders should be made payable to Illiffe & Sons Limited.

SPECIAL NOTE.—Readers who reply to advertisements and receive no answer to their enquiries are requested to regard the silence as an indication that the goods advertised have already been disposed of. Advertisers often receive so many enquiries that it is quite impossible to reply to each one by post.

"WIRELESS WORLD" INFORMATION COUPON

This Coupon must accompany any Question sent in before
JUNE 11th, 1930

For Particulars of Free Service, see Rules on page 595.

Mention of "The Wireless World," when writing to advertisers, will ensure prompt attention.



ALL WIRELESS WORLD COILS, DIALS & CABINETS
Short Wave Coils, etc.

B&J. Wireless Co.
2, 3, & 4, Athelstane Mews, Stroud Green Rd., N.4.
Archway 1695.

POWER CHOKES

guaranteed twelve months substantially built, for smoothing circuits in eliminators dealing with currents up to 300 milliamperes, inductance 30 henries, 8/6 post free

REPAIRS

to any make of L.F. Transformer, Loudspeaker or Headphones. All repairs dispatched within 48 HOURS. TWELVE MONTHS' GUARANTEE with each repair. 4/- Post Free. Terms to Trade

TRANSFORMER REPAIR CO.

Dept. W.,
953, GARRATT LANE, Tooting, London, S.W.17.

BE SAFE!

FOR RADIO PART EXCHANGE

APPLEBY'S

"Where it all began."

CHAPEL ST., MARYLEBONE, LONDON, N.W.1.
Paddington 8828 (3 lines).

Particulars upon request.



THE Scientific Logarithmic Horn

Read what "Wireless World" said in May 28th issue:—

"No noticeable horn resonances... clear and crisp... middle register and bass well brought out... Combination of Unit and Horn very sensitive... Good volume with small output valve."

Length 5 feet. Flare 25 inches. Specially designed for home use. Inconspicuous and of pleasing appearance. Can be suspended in corner of room and will harmonise with all furnishings.

Equalled only by a good moving coil speaker. Will satisfy the most critical ear.

Horn with Baldwin Type Balanced Armature Unit. Complete £2:0:0. Horn with Brown U/GA Unit. Complete £2:18:6. A combination making the finest loud speaker obtainable. Satisfaction guaranteed.

19/6

HORN ONLY

SCIENTIFIC SUPPLY STORES,
126, Newington Causeway, London, S.E.1

IMPORTANT NOTICE.

Owing to the Whitsun Holidays, the next issue of "THE WIRELESS WORLD" (dated June 11th) is closing for press earlier than usual.

In accordance with the Notice that appeared last week, the latest date upon which Miscellaneous Advertisements could be accepted for the above issue was **FIRST POST WEDNESDAY, June 4th.**

RECEIVERS FOR SALE.

SCOTT SESSIONS and Co., Great Britain's Radio Doctors.—Read advertisement under Miscellaneous. [0264]

HIRE a McMichael Portable Set, by day or week, from Alexander Black, Wireless Doctor and Consultant, 55, Ebury St., S.W.1. Sloane 1655. [0328]

STEREOPHONIC Couplers!—Send for new leaflet giving full particulars; the world's finest coupling device, amazing tone, many used in talkies.—N. Bonavia-Hunt, 96, Broadhurst Gardens, N.W.6. [9476]

LISSEN, Cossor, Mullard, Osram sets, etc., and spare parts supplied; cash or easy payments; Provident and other trading checks accepted.—Acacia Stores, Ltd., 229-231, Upper Tooting Rd., S.W.17. [9564]

THREE-VALVE Set, with loud-speaker, 2 pairs Brown's A phones, large Geophone Crystal set, many components; lot, first £5.—Smith, Newbiggin, Drumchapel, Glasgow. [9630]

FOR Sale, Orgola Senior (in mahogany cabinet), with or without 6-volt valves, also Ekco eliminator, D.C., model No. 5T60.—Offers to L. Alexander, 9, Queen's Parade, Muswell Hill, N.10. [9626]

PHILIPS 4-valve All Electric Receiver, 230 volts, latest model, for sale.—Vandervell, 15c, Cliford St., Bond St., W.1. [9627]

MARCONI Straight Eight, just overhauled by makers, new valves fitted, long and short wave coils, Marconi H.T. eliminator, 240v. x 50c. and 6v. accumulator; no reasonable offer refused.—Apply H. Ellis, 22, Market Place, Burslem, Stoke-on-Trent. [9621]

ALL Mains Sets for Sale Privately, Philips 2511, £25; Burndept 5-valve, all wave, £25; Foreign Listener's Four, experimental board, £12; all A.C. 200-220; can be seen any evening by appointment.—T. A. Clements, 76, Norbury Court Rd., S.W.16. Tel.: Pollards 2931. [9620]

GETTING Down To It!

A GOOD Portable for £9/19/6, complete with 5 standard English valves and English batteries, weighing 22lb., in a strong case of pleasing and simple design. Lizard grained finish, one-dial tuning, of performance and tone surpassing many portables of three times the price. No rash claims are made—produced by Appleby's, and is real value for money.

FOR Some Time Past there Has Been a Want for a Simple Straight Portable—for the individual who requires it as a portable—when he is in motion, but—the price must be reasonably low, for its use does not justify a heavy outlay to the person, whatever the depth of his pocket, mainly using a permanent receiver.

THEREFORE Appleby's have deviated from Their Usual Programme of Money's No Object and Got Down to It.

WHY Not Invest in One? A portable banishes dull moments, it's a companion you can switch off, and it does not cost a lot to take around.

GET One—it's worth it. It's produced by Appleby's, and, in its class, is worthy of a treasured name.

IF You Live Away from London, and cannot inspect before purchase, buy one anyway, because, well, it's Appleby's, and the portable won't leave if it's wrong.

£9/19/6 complete from Appleby's, Chapel St., Marylebone, London, N.W.1. Phone: Paddington 8828 (3 lines). [0338]

PORTABLES.—5-valve complete suitcase models, new, £6/10; D.C. mains set, 2-valve, 110v., D.P., complete, £4; send for free list of real cheap components.—Butlin, 143b. Preston Rd., Brighton. [9670]

RADIO-GRAMOPHONES.—Rhapsody-Twin to be disposed of by Liquidator, Reproduction, Ltd., 5, Dysart St., Wilson St., E.C.2, at less than one-third list, mains mahogany 5v. M.C. L.S., electric motor; also oak and mahogany corner L.S. baffles. [9661]

BERCLIF D.C.2 All Mains Receiver, 200 to 250 volts D.C.; price £14/10; with valves and royalties; suitable for M.C. speaker; particulars free; trade inquiries specially invited.—Simmonds Bros., Shireland Rd., Smethwick. [8734]

Receivers for Sale.—Contd.

RECEIVERS Constructed, modernised or converted; H.T. eliminators (new), from 48/-; stamp for particulars.—H. Burdett, B.Sc., Firth Park Crescent, Sheffield. [9662a]

YOUR Old Receiver or Components Taken in Part Exchange for New; write to us before purchasing elsewhere, and obtain expert advice from wireless engineer of 25 years' professional wireless experience; send a list of components or the components themselves, and we will quote you by return post; thousands of satisfied clients.—Scientific Development Co., 57, Guildhall St., Preston. [0226]

RADIO-GRAMOPHONE 3v. S.G.P., A.C. mains, 200-250v., 18 guineas.—Evenings, 20, West Hampstead News, West Hampstead, N.W.6. [9654]

PHILIPS 3-valve All Main Type 2514, practically new, 200 volts 50 cycles; £16.—6, Corporation Rd., Croydon. [9646]

MARCONI 44 valves, perfect condition, cost £27; too powerful; £17, or Philips Three and £10, or near—Nowwood, George Rd., Solihull, Birmingham. [9640]

ACCUMULATOR HIRE.

DON'T Buy Accumulators or Dry Batteries, join our C.A.V. low and high-tension accumulator hire service, the largest and best in London; better and cheaper reception with no trouble; regular deliveries within 12 miles of Charing Cross; no deposit, payment on each delivery or by quarterly subscription; over 10,000 satisfied users; explanatory folder post free; phone or write to-day.—Radio Service (London), Ltd., 105, Torriano Av., N.W.5. Phone: North 0623-4-5. [8751]

ACCUMULATORS—BATTERIES.

WET H.T. Replacements.—Sacs (capped or uncapped), highest grade, No. 1, 10d. per doz.; No. 2, 1/9 per doz.—See below.

ZINCS.—Best quality (wired), No. 1, 8d. per doz.; No. 2, 9d. per doz.; orders valued 5/- carriage paid, otherwise 6d. for postage.—British Battery Co., Clarendon Rd., Watford, Herts. [0258]

EDISWAN H.T. Accumulators, 144v., oil covered, in good condition; £2.—41, Berwick Rd., Wood Green. [9633]

120 V. Exide H.T. Accumulator, W.H.10, perfect; view Sutton.—Box 6279, c/o *The Wireless World*. [9668]

CHARGERS AND ELIMINATORS.

CHEBROS.—Chebros for all types of transformers and chokes, high grade instruments at a very moderate price; enquiries invited.—Chester Bros., 244, Dalston Lane, London, E.8. [5290]

TANTALUM and Lioniium for A.C. Rectifiers; for inexpensive chargers; blue prints for H.T. and L.T., 1/- each; Lioniium electrodes, 2-3 and 5-8 amps.—Blackwell's Metallurgical Works, Ltd., Garston, Liverpool. [8298]

PHILIPSON'S Safety High Tension Supply Units for A.C. and D.C. Mains, 200-250 volts 40-60 cycles, also 230 volts 25 cycles.

10/- Down and Small Monthly Payments Secures the Finest H.T. Supply Available.

PHILIPSON'S Safety H.T. Units are Guaranteed for 12 Months Against All Defects.

ALL Models Sold on 7 Days' Approval to Ensure Complete Satisfaction.

PHILIPSON'S Safety H.T. Units are the Cheapest to Install and the Cheapest to Run; £1/17/6 to £6.

WRITE for Our Booklet "Radio Power," which gives illustrations and full particulars.

PHILIPSON'S Safety Loud Speaker Output Filters for All Receivers, power valve, or Pentode; a remarkable output filter at a very low price; 16/6.

PHILIPSON and Co., Ltd., Radio Engineers, Astley Bridge, Bolton. Phone: 2038 Bolton. [0318]

ALWAYS Potential Dividers, 20 m.a. type, all values, with 5 variable tappings; 2/6, post free.—Below.

ALWAYS Potential Dividers, 50 m.a. type, wire wound, 5 tapping, 20,000 ohms; 4/8, post free.—Below.

IF Your Dealer Does Not Stock, send direct and ask for complete list of Always Resistances.—Abingdon Wireless Supplies, Abingdon, Berks. [9478]

GECOPHONE 200-260 A.C., 2 variable tappings, output tapping 200 volts, 40 milliamps; £6. cost £9.—59, Atherley Rd., Southampton. [9651]

ZAMPA H.T. Eliminator Kit, comprising rectifying unit (incorporating transformer, condensers, Westinghouse H.T. 3), necessary condensers, choke, terminals, baseboard, etc., output 120 volts at 20 m.a., complete; 45/-; 7 days' approval against cash; other Zampa kits and transformers on request; amateur constructors' enquiries invited.—Mic Wireless Co., Market St., Wellingborough. [9636]

HAVE YOU SEEN THE LOTUS ALL ELECTRIC TRANSPORTABLE?



3 Valves Only yet giving 5 Valve Power

All Electric, instead of Battery operated; employing only three valves instead of the usual four or five, yet losing nothing in strength or clarity, the Lotus S.G.P. All Mains Transportable Receiver stands alone in its class.

Entirely self-contained—needs no aerial or earth wires—Loud Speaker included in cabinet—mounted on turntable for directional reception—running costs approximately 4/- per annum.

Prices: Oak Cabinet, £25. 4s. cash, or £2. 7s. down and 11 equal monthly instalments. Mahogany or Walnut Cabinet, £26. 5s. cash, or £2. 9s. down and 11 equal monthly instalments.

Write for full particulars:

LOTUS ALL ELECTRIC TRANSPORTABLE

Garnett, Whiteley & Co. Ltd. (Dept. "W.W." 8), Lotus Works, Mill Lane, Liverpool.

Chargers and Eliminators.—Contd.

REGENTONE Portable Model A.C. Eliminator, almost new; 55/-.—Freeth, 40, Aberfoyle Rd., Streatham Vale, S.W.16. [9653]

RADIELLE Model G.P. (200-250 A.C.), output 200 volt 55 ma., and 2 variable tappings; cost £9/17/6, sell £3/10; brand new, sent c.o.d.—Priestley, 74, Aberdeen Rd., Highbury, London, N.5. [9655]

POST Free Bargains. — Approval, guaranteed, shrouded ironcore smoothing chokes, 500 ohm, 20 ma., 2/-; ditto windings, tapped, capped, 0-300-500 ohms., 5/-; multi panel 4-pole lever change-over switches, 1/-.—Oliver, 325, Kennington Rd., London. [9652]

CHARGING Kits, low tension, 2, 4, 6-volts, 30/- cash.—Radio, 70, Washington Rd., Sheffield. [9647]

SAVAGE'S Specialise in Wireless Power from the Mains, reliable apparatus at reasonable prices.

SAVAGE'S.—Transformer laminations and Bakelite hobbins; intending home constructors should write for list.

SAVAGE'S.—Reliable smoothing condensers, 1,500 volt D.C. test, 1 mfd., 2/-; 2 mfd., 3/-; 4 mfd., 5/3; 500 volt D.C. test, 1 mfd., 1/6; 2 mfd., 2/3; 4 mfd., 3/9.

SAVAGE'S.—Super smoothing and output chokes, many types available; write for list.

SAVAGE'S.—Mains transformer for Westinghouse H.T.4 unit, with additional winding, 4 volts centre tapped 3 amps, 23/-; transformers for other Westinghouse units available.

SAVAGE'S.—Mains equipment for new Foreign Listeners Four, transformer N.F.L.4, 33/-; smoothing choke, C32G, 20/-; output choke C32O, 20/-.

SAVAGE'S Mains Equipment for Power Pentode Two Transformer, P.P.2, 33/-; output choke, L.C.36P.G., 19/6; smoothing choke, L.C.36G, 18/-.

SAVAGE'S.—Mains transformer B.T.4, 500-0-500 volts, 120 m. amps., 7½ volts 3 amps., 6 volts 3 amps., 4 volts 2 amps., 4 volts 1 amp., 4 volts 1 amp., all centre tapped, specially developed for automatic bias; 57/6.

SAVAGE'S.—Mains transformers and power chokes are carefully and individually constructed from first class materials, with an exceptionally generous margin of safety.

SAVAGE'S, 146, Bishopsgate, London, E.C.2. Phone: Bishopsgate 6998. [9165]

CABINETS.

DIGBY'S Cabinets.—Table models in solid oak and mahogany; from 11/6 to 71/-.

DIGBY'S Cabinets, fitted with Radion or Resiston ebonite if required.

DIGBY'S Cabinets.—Pedestal model, with separate battery components; from 56/- to £12.

DIGBY'S Cabinets Made to Customers' Own Designs.

DIGBY'S Cabinets.—Write for new 16-page art catalogue.—F. Digby, 9, The Oval, Hackney Rd., E.2. Phone: Bishopsgate 6458. [0128]

KAY'S Cabinets, the greatest range of pedestal cabinets in the kingdom; original creative designs at prices 50% lower than elsewhere; quotations for specials by return; delivery at short notice guaranteed.

RADIOGRAM Cabinets.—A variety of really practical and exclusive models from 60/-; illustrated lists free.

H. KAY, Wireless Cabinet Manufacturer, Mount Pleasant Rd., London, N.17. Phone: Walthamstow 1626. 8963

COILS, TRANSFORMERS, ETC.

TRANSFORMERS and Chokes for Battery Eliminators.—Chester Bros., 244, Dalston Lane, London, E.8. [8652]

1,000 ohms Decoupling Resistances, specified for Power Pentode Two; 1/6 each.—Groves Brothers.

600 ohms Decoupling Resistances, specified for Groves Kilo Mag Four; 1/6 each, post free.—Groves Brothers.

120 and 1,000 ohms Resistances for new Foreign Listeners Four; 1/6 each, post free.—Groves Brothers.

NEW Kilo-Mag Four Coils, 37/6 set; slotted coil formers, for winding, Kilo-Mag Four 12/6 set, 1950 Everyman Four 8/6 set; Kitset 10/6 set; Ideal home receiver 9/- set, all post free.—Groves Brothers, St. Mary's Place, Shrewsbury. [9361]

BAND-PASS Filter H.F. Transformers and Aerial Units, for flat top tuning and no cutting of sidebands, dual wave; 18/6 each.—Groves Brothers, St. Mary's Place Shrewsbury. [9362]

BERCLIF Coils, the standard of excellence, for all "Wireless World" receivers; latest lists post free; trade supplied, all quantities.—Simmonds Bros., Shireland Rd., Smethwick. [8735]

DEAF AIDS

(INEXPENSIVE)

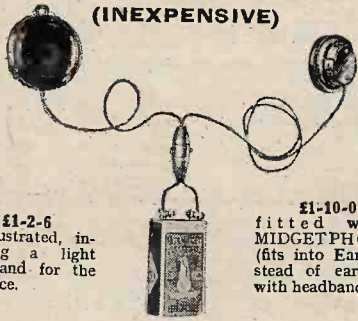

£1-2-6 as illustrated, including a light headband for the earpiece.

£1-10-0 fitted with MIDGETPHONE (fits into Ear) instead of earpiece with headband.

THIS Aid comprises the latest sensitive SUPER-MICROPHONE (to be attached to Coat or Dress, conveniently concealed), a SMALL BATTERY (for the pocket), and a SMALL EARPIECE which can be held to the deaf ear by hand or by a light headband supplied with the Aid. All speech and sound reaching the Super-Microphone is loudly heard in the earpiece. The battery can be switched off when the Aid is not in use.

Full particulars post free.

FREDK. ADOLPH, Actual Maker, 27, Fitzroy St., London, W.1. Phone: Museum 8329.

Is your set Thirsty?

Is your receiver getting all the power it requires to give its best? No? Have you tried the mains? Build an eliminator that will give unsurpassable service with



POWER TRANSFORMERS

Used in conjunction with a Westinghouse metal rectifier your set need never be thirsty.



21". The type illustrated is W.14 for mains of 200-250v. 50 cycles.

F. C. HEYBERD & CO., 10, Finsbury St., E.C. Phone: Clerkenwell 7216

Mention of "The Wireless World," when writing to advertisers, will ensure prompt attention.

Coils, Transformers, Etc.—Contd.

MILTRO Screen Grid Coils.—Important release to the general public; hitherto, only used by manufacturers of successful 3, 4, 5-valve sets; this compact tuned-anode and reaction coil has one-hole fixing incorporating wave-change switch; no screens required, even on screen-grid valve; price, with blue print, 7/9, post free, or c.o.d.—Miltro, 743, Commercial Rd., E.14. [9658]

MARCONIPHONE L.F. Transformers, as fitted in famous V.2 receiver, excellent for portables: 3/- each.—22, Cornwall Rd., Bedford. [9642]

FERRANTI A.F.5, O.P.M.1(c) and A.F.5c (for push pull circuit), all practically new; £2/10.—Money, 146, Fleet Rd., Hampstead, N.W.3. [9641]

GRAMOPHONES, PICK-UPS, ETC.

PAILLIARD Electric Gramophone Motors, with turntable, 200-250v. A.C., unique principle, no brushes or belt, silent, steady, only 2 main moving parts, automatic stop and switch; £4/10; sent on 7 days' approval against cash.—Watkins and Richardson, 1,148, London Rd., Norbury, S.W.16. [9489]

VARLEY; 25/-; with tone arm.—Fawkes, Queen's Rd., Cheadle-Hulme, Ches. [9634]

BURNDEPT Radio Gramophone, cost £44, accept £24; magnificent Stirling 4-valve cabinet set, cost £105; accept £20; Magnavox speaker, 6v., £5; B.T.H. latest pick-up and tone arm, 25/-; all privately owned and in perfect order; must sell.—"Beechcroft," Watling St., Radlett. [9625]

PICK-UPS, new T.S.G., efficient, easily fitted; 9/6, post 3d.; list components free.—Butlin, 143b, Preston Rd., Brighton. [9672]

MARCONIPHONE, 1930, latest type, unused; £2/2; A.F.3 transformer.—59, Atherley Rd., Southampton. [9650]

NEW Collaro Motor, cost £2/12, C27 model; accept £1/15; particulars gladly.—60, Sherburn Terrace, Consett. [9644]

B.T.H. Pick-ups and Tone Arms, cranked; 22/6 each; send for list.—G2VM, 27a, Bridget St., Rugby. [9639]

TRANSMITTERS.

CHEBROS. Chebros. Chebros transformers and chokes of all descriptions, special transformers for transmitting and modulation; chokes a speciality; enquiries invited.—Chester Bros., 244, Dalston Lane, London, E.8. [5240]

VALVES.

AMPLIFIER Valve.—If you require power you cannot do better than one of these:—

FILAMENT Volts 6, plate volts 400 (maximum), grid bias 84 volts (approx.), impedance 800 ohms, amplification factor 3.8, mutual conductance 4.35 m.a./volts; price £5/10; see article "The Wireless World," 24th July, 1929, then send to North London Valve Co., Ltd., 22½, Cazenove Rd., Stoke Newington, London, N.16. [9657]

LOUD-SPEAKERS.

BAKER'S SELHURST RADIO 36-page Booklet, "Sound Advice is Yours for the Asking"; write now for new edition; see displayed advertisement on page 13. [0231]

PERARDUA Moving Coil Reproducers.—These superlative instruments may be obtained for 15/- down, balance by 5 equal monthly payments; cash prices, 230-volt D.C., £3/3; 6-volt, £3.—R. Vevers, 4, York Rd., Maidenhead. [9551]

CELESTION C.14, as new; £6, or nearest offer.—Geddes, Jeweller, Arbroath. [9618]

AMPLION Lion L.C.41, oak cabinet, just overhauled by makers; no reasonable offer refused.—C. Tangye, Broome, near Stourbridge, Worcestershire. [9624]

BROWN Duplex Cont, V15, cost £12/10, perfect; £5/10.—59, Atherley Rd., Southampton. [9649]

BROWN Q Model, beautiful tone and quality; accept first £7.—Details, 60, Sherburn Terrace, Consett. [9643]

OXIDISED Copper Drum Type Loud Speaker Cabinets for 14in. Cone; 4/6; 7 days' approval against cash; cost double.—Mic Wireless Co., Market St., Wellesborough. [9637]

HIGHLY Sensitive Permanent Magnet Moving Coil Speakers, no mains or batteries necessary, complete with 35% cobalt steel magnets and high resistance moving coils; £3/10.—Duddles, 102, Cranford Lane, Heston, Middlesex. [9645]

Make Use of The Wireless World AND RADIO REVIEW DEPOSIT DEPARTMENT

A recent user writes:

"Please accept my thanks for the services rendered in the purchase of the eliminator which I have decided to keep. You can therefore forward the money to the seller with my thanks.

"I shall always praise your Deposit System which is the safest way of dealing with strangers that I know of."

W. H. THEWLIS, 49, Webster Street, OLDHAM, Lancashire.

Full particulars of "The Wireless World" Deposit System are given on the first page of Miscellaneous Advertisements.

w.w.94.

STUPENDOUS!

A recent advertiser in "THE WIRELESS WORLD" writes as follows:

"As the results from my advertisement in 'The Wireless World' were stupendous, I shall be glad if you will cancel my advertisement in next week's issue as I am cleared out.

I might add that 'The Wireless World' is the best journal I have read."

W. F. Macbeth, "Brænar," Ballymena, Ulster.

w.w.89.

Loud-Speakers.—Contd.

EPOCH Moving Coil Speakers are Masterpieces, designed and produced by master engineers.

EPOCH Moving Coil Speakers are the Standard by which other Speakers are Compared.

EPOCH Moving Coil Speakers are in Use in Many Editorial Offices.

EPOCH Moving Coil Speakers are in Use in Several Famous Laboratories.

EPOCH Moving Coil Speakers are in Use in Many Broadcasting Stations.

EPOCH Moving Coil Speakers are in Use by Most Prominent Musicians.

EPOCH Moving Coil Speakers Bring Unbounded Joy to Thousands upon Thousands of Homes.

EPOCH Moving Coil Speakers, the only speakers that give clear, uncoloured reproduction.

EPOCH Moving Coil Speakers do Render Speech Perfectly and Music Correctly.

EPOCH Moving Coil Speakers Provide the Perfect Illusion of the Artist's Presence.

EPOCH Moving Coil Speakers Represent the Finest Intrinsic Value Ever Offered.

EPOCH Moving Coil Speakers are Guaranteed for a Year, but last for ever.

EPOCH Moving Coil Speakers Bring the Grand Concert out of the Most Modest Set.

EPOCH—You can hear a hundred moving coil speakers, but Epoch is different.

EPOCH—If you own the best set, only by Epoch can you confirm it.

EPOCH—Away with the tin can and cracked banjo reproduction, and install an Epoch.

EPOCH—Away with the drumminess, droniness and huskiness of the average moving coil speakers.

EPOCH—The clearest, sharpest, cleanest reproduction—a marvel of accuracy and beauty.

EPOCH Moving Coil Speaker Models from £2/10 to £30.

EPOCH Moving Coil Speakers.—Models for every requirement and taste.

EPOCH Permanent Magnet Moving Coil Speakers.—Nine models from £3/15.

EPOCH Permanent Magnet Moving Coil Speakers Require no Mains or Batteries.

EPOCH Permanent Magnet Speakers are more Sensitive than most Energised Moving Coil Speakers.

EPOCH Energised Models are the Finest ever put on the Market.

EPOCH Super Cinema Speaker has Created the Biggest Sensation for Many Years.

EPOCH Super Cinema Model is many times as Sensitive as the so-called Supers.

EPOCH Super Cinema Speakers give Enormous Volume from a 1-watt Amplifier.

EPOCH Super Cinema Speakers are used on many 100-watt Amplifiers and never "rattle."

EPOCH Super Cinema Model is Standard on several Talkie Equipments.

EPOCH Super Cinema Model is already in use in over 200 Cinemas.

EPOCH Super Cinema are the only Moving Coil Speakers used in Large Theatres, unaided.

EPOCH Super Cinema Speakers provide alone the Upper as well as the Lower Register.

EPOCH—Other Moving Coil Speakers require the help of exponential horns to provide depth.

EPOCH—A list of many prominent cinemas using the Speakers supplied on request.

EPOCH Speakers are not Made of Tin or Aluminium Stampings, but are sound, solid, engineering jobs

EPOCH Heartily Invite Comparison, on all counts, with any make, regardless of price or claims.

EPOCH—Don't accept our quality claims without verification, but don't accept any other maker's either.

EPOCH—Order one of 7 days' approval, and test with a switch-over; the only real test.

EPOCH Moving Coil Speakers may be heard in our Demonstration Room Daily.

EPOCH—Our demonstration room is in the heart of London.

EPOCH—Its accessibility has been studied for the convenience of callers.

EPOCH—If you cannot call, write for booklet W.S.3, and approval terms.

EPOCH RADIO MANUFACTURING Co., Ltd.
Farringdon Av. (near Ludgate and Holborn Circuses). Phone: Central 1971. [8983]

Features that matter

It's when you begin to look into J.B. Condensers that you appreciate their precision, accuracy and finish.

This is the Universal Log—one of the most popular condensers this year, and one which will set the "fashion" for next season.

The frame construction is such that complete rigidity is assured.

PRICES:

•0005 - 9/6 •0003 - 9/-
•00025 - 8/9 •0015 - 8/9



This panel fixing bush can be transferred to the other end of the adjustable spindle, making the Condenser left hand.

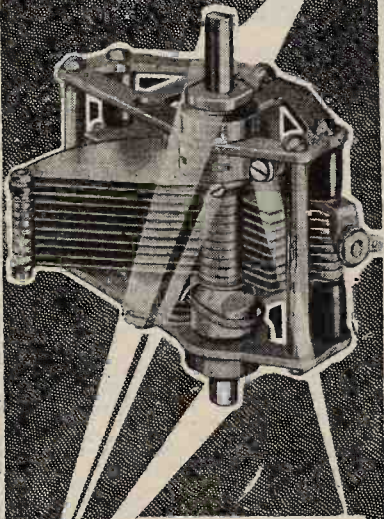

Showing the well-known J.B. adjustable tension to Centre Spindle, a feature every wireless enthusiast looks for in a Condenser.

This Steel Centre Spindle is adjustable for length by slacking the set screw. (This operation does not affect the alignment of the vanes.) Particularly useful for ganging and attaching to Thumb or Drum Control.

Advertisement of Jackson Brothers, 72, St. Thomas' Street, London, S.E.1. Telephone: Hop 1837.

COMPONENTS, ETC., FOR SALE.

BELLING-LEE Panel Fittings are designed to give an expert finish to any home-constructed set; catalogue post free.—Belling and Lee, Ltd., Queensway Works, Ponders End, Middlesex. [0018]

WESTON Model 301, milliameters, ammeters, and voltmeters, 21/- each; hot wire ammeters 0-1 amps., 4/-; 0-0.5 amp., 3/-; instrument repairs and alterations; send for list.—The Victoria Electrical Co., 47, High St., Battersea, S.W.11. Established 1910. [8626]

COMPONENTS Lent on Hire.—Details from Alexander Black, Wireless Doctor, 55, Ebury St., S.W.1. Sloane 1655. [0329]

1,000 ohms Decoupling Resistances, specified for Power Pentode Two; see advert. under Coils.—Groves Brothers. [9461]

DESIGNER has for Disposal, used on test for short period only, 2 Hegra dynamic speakers (equal to M.C.), 30/- each; 7-1 ratio Ferranti transformer, 25/-; 4 L.S.5A, 15/- each; pair Ferranti push-pull transformers, £1/10; 1 P.M.24A, 20/-; 1 A.C./P.1, 12/6; 3 D.E.L.610, 7/- each; 1 A.C./S., 15/-.—Box 6263, c/o The Wireless World. [9619]

BANKRUPT Bargains.—Falco L.F. transformers, 2/9; 0.0005 variable, 2/6; Triotron cone units, 8/6; others, 4/-; pick-ups, 9/6; H.F. chokes, 1/6; Ecco D.C. all-mains units, C2A, 75/-; all goods new; new list free.—Butlin, 145b, Preston Rd., Brighton. [9671]

FINAL Disposal of Parts by The Liquidator, Reproduction, Ltd., 5, Dysart St., Wilson St., E.C.2.

CALLERS Only.

GRAMOPHONE Motors, electric, G.E.C., 40/-; spring Garrard, 10/6; turntables, 10in. and 12in., 9d.; pick-ups, B.T.H., gilt, 22/6; accumulators, Exide 3C.Z.6 18/6, W.H.10 3/6; transformers, Telsen Ace 3/-, Magnavox output 25:1 5/-, Zenith power 1:1 30/-, Pye 680 6/-; chokes, H.F. Climax 2/6, Woodfull 9d., L.F. Rich and Bundy 5/-; condensers, variable, Burton 0.0005 1/9, 0.00025 1/6, G.E.C. 0.0005 3/6, Cyldon 0.00025 2/6, fixed, various capacities, 4d.; coils, Colvern, Reinartz, and base 1/-, dual range 1/3; R.C.C. Dubilier 1/6, Relays 2/6, Igranite res. 6d.; eliminators, Met-Vick L.T., 7/6; valves, Osram L.S.5A, L.S.5 7/6, H8 4/-, H610 3/-, Mullard P.M.5X 3/-, 25G 4/-, 26 7/6, Marconi L and H210 5/-, L410 3/-, Met-Vick A.C.P.1 7/6, A.C.R. 5/-; superhet. kits, wired, 5/-; also switches, grid leaks, panels, tone arms, wave traps, cones, tools, etc.; cowhide portable case, 17in. x 17in. x 9in., 15/-; converter, D.C. to A.C., £6; electric fan, 110 D.C., and fire, typists' tables, work benches, and stools. [9660]

M.C. Speakers, pick-ups, cone speakers, microphones, transformers, etc.; send for list.—G2VM, 27a, Bridget St., Rugby. [9638]

RADIO HOUSE, HUDDERSFIELD, issues the Reliability Wireless Guide, which will be sent post free upon request by Messrs, J. H. Taylor and Co., 15, Macaulay St., Huddersfield. [7823]

PART Exchange.—See our advertisement under Receivers for Sale.—Scientific Development Co., 57, Guildhall St., Preston. [0228]

A LIMITED Number Only, now is your chance.—All the following, unless otherwise stated, are genuine Burndep manufacture, and you know Burndep quality. Suitcase type portable cabinets in leather, inside measurements 14 1/2 in. x 14 1/2 in., slightly used, otherwise perfect, 12/6 each; Ethodyne solid mahogany cabinets to take panel 23in. x 10in., with raised panel, double front doors, in new condition, worth at least £7, our price 35/-. H.T. eliminator oak cabinets inside measurements 14in. x 8 1/2 in. x 7 1/2 in., deep, hinged lid, 6/- each, new condition; solid mahogany portable cabinets, inside measurements 14 1/2 in. x 14 1/2 in., condition as new, 25/- each, worth treble; double linen chassis, 19in. x 14 1/2 in. (this is a solid job, complete with centre chuck fitted all ready to have unit attached), our price 19/6 each, or with special bracket to mount Ormond unit, 22/-, practically any type unit can be mounted on these chassis.

HEAVY Duty Wire Wound Resistances, each one being tapped to give following resistances, No. 1182, 3,000-2,500-5,500 ohms; No. 1175, 330-600-750-1,350 ohms; No. 1177, 540-1,000-1,500-2,150 ohms; No. 1185, 5,000-7,500-12,500 ohms; No. 1186, 6,000-10,000-15,000-25,000 ohms; No. 1191, 62,500-125,000-250,000 ohms, all one price, 3/6 each; all above genuine and guaranteed Burndep manufacture.

WESTERN ELECTRIC 2-valve Amplifiers, in original cartons, brand new, each amplifier containing two transformers, one being tapped to volume control switch on panel, also output transformer, resistances, condensers, valve holders, etc., only 6 left, £1 each; also 8 only ditto 3-valve amplifiers, with one or two sundry parts damaged or missing, not in original cartons, to clear at 14/6 each, with guarantee of transformers, etc., being perfect; Burndep Radio Gramophone cabinets, in mahogany, condition as new, £8 each; all goods carriage paid.—Hughes and Sons, 149, Chepstow Rd., Newport, Mon. [9674]

**IN
"RADIO FOR THE
MILLION."**



5/9

Belling-Lee 9-way Battery Cord with Belling-Lee Wander Plugs and Spade Terminals.

Also specified:—Belling-Lee Terminals Price 6d.

BELLING-LEE
FOR EVERY RADIO CONNECTION

Advertisement of Belling & Lee Ltd.,
Queensway Works, Ponders End, Middlesex.

**TUBUS
CONDENSER**

Write for your copy of Test-Report & Illustrated Leaflet to

FONTEYN & Co. Ltd.
210, 6, Blandford Mews, Baker Street - W.1.

EXACT TUNERS

250 to 2,000 metres.

No further coils are required, tuning is as simple as A.B.C., see "Wireless World," January 25th: "We can strongly recommend these tuners." Send postcard for particulars and Circuits FREE to

THE EXACT MANUFACTURING CO.
Croft Works, Priory Place, COVENTRY.

**"APTUS" LINEN DIAPHRAGM
TRIPLE CHUCK ADAPTER
FITS ALL UNITS**



COMBINED BRASS AND CELLULOID WASHERS. PREVENTS RATTLE.

EXPERTS SAY:—"The most Successful Centre yet Devised."

PRICE 2/6
POST 3d.

"APTUS" DOPE .. 10 oz. 2/9
DOPE BRUSH .. 6d.
IRISH LINEN for 22 inch .. 7/6
8 ANGLE BRACKETS with:
Screws .. 1/6
RUBBER .. 6d. yard
SET (4) 2 B.A. RODS (18 NUTS and WASHERS) .. 1/6

UNITS. Post Free.
APTUS 17/8. BLUE SPOT 25/-.
HEGRA 19/- CHIMES 16/8. Etc.

**ORDERS OVER 10/-
POST FREE.**

Makers of "APTUS" Specialties.

MOORE & Co.
(Est. 50 YEARS)
101 & 103 Dale Street, LIVERPOOL
Phone: Cen. 5284. Grams: "Solutions."

Components, Etc., for Sale.—Contd.

LEWCO'S Dual Binocular Coils, 1 D.B.A., 2 D.B.G., 11/- each.—Isaac, 108, Shaftesbury Avenue, Southampton. [9617]

VARLEY Pentode Outfit Transformer, 12/-; type D R.C. compler 6/-; Gossor 410 L.F., 5/-; P.M. 24, 12/6; R.I. Push-pull, output, 15/-; general purpose transformer, 7/6.—Chapple, 9, Ryfold Rd., Wimbledon Park. [9628]

WILBURN and Co. for Magnavox and A.C. Equipment for Electric Dynamic Speakers.

MAGNAVOX for £3/3, carriage paid Great Britain, in manufacturer's sealed case.

MAGNAVOX D6, without speech transformer, 1929 model, 7/4in. cone, new; £3/3.

MAGNAVOX D6 Incorporates Hum Neutralising Coil, limited number of these speakers available.

A.C. Equipment, suitable for these speakers, mains transformer, 14 volts 2 amperes, 18/-; metal rectifier, 7 volts 2 amperes, 22/6.

ELECTROLYTIC Condensers, 2,000 mfd., 15/-; 10-volt 2 amperes rectifiers, 26/6.

WILBURN and Co., 23, Bride Lane, Ludgate Circus, E.C.4. Central 6994. [9673]

NEW Marconiphone Pick-up, 45/-; Amplion B.A.2 unit, 14/-—22, The Chase, Watford. [9669]

PYE 32 henry L.F. Choke, 6/-; R.I. and Varley H.F. choke, 6/-; 2v. P.M. screened grid valve, 8/-; 0.0002 Formo variable condenser, 2/-; 2 mfd. C.C.C., 2/-; 0.00025, 0.0001 T.C.C., 1/- each; 2 0.01 Dubilier condensers, 1/- each; Ferranti wire wound resistances, with holders, 10,000 ohms, 1-100,000 ohms, 1-2,000 ohms, 1-5000, ohms, 2/6 each.—Box 6277, c/o *The Wireless World* [9666]

NEW Kilo-Mag Four Coils, 26/- set; Mullard permacore transformer, 14/-—Box 6276, c/o *The Wireless World*. [9665]

M.C. Meters, 4in. C.Z. dials, Milliammeter (5, 25, 50), by Schall, cost £12, new condition £3/10; another, by Cavendish Electric (5, 25, 250), cost £10, £2/10; microammeter (0-500) and millivoltmeter (0-1,000), £2; voltmeters, G.E.C. 6in., 0-250 25/-; another, 0.5, 12/6; M-iron, 0-200, full scale, 10 m.a., 7/6; valves (new), 2 matched L.S.6As, L.S.5s, 1 L.S.5a, P625, half list; 104v., 10/-—Bennett, 90, Connor Rd., Dagenham. [9663]

A.F.3 Transformer, 10/-; Osram 8625's, 5/-; wanted, 50v. accumulator, choke.—73, Fairfax Rd., Herts. [9656]

WIRELESS Transmitting Sets for Morse Telegraphy or Distant Control of Models, etc., 1in. spark coil, condensers, spark gap, helix, etc., very compact, complete and ready to use, 12/6; high quality buzzer, good note, 3/6; heavy Morse tapping key with points, 3/6.—Below.

ELECTRIC Motors, 1/2 to 1 1/2 h.p., 110 to 220 volts D.C., silent running, carbon brushes, in perfect condition and working order, suitable for gramophones, television, or any small power uses, 10/-; a few with overheated windings, if rewound make good dynamos for H.T. accumulators, 6/-—Below.

COMPLETE Portable Telephone, magneto ringing, ready for use, 17/6; hand telephones, 4/6; 1,000 ohm H.F. chokes, 1/-; large earphones, 1/3; G.P.O. magnetic relays, high class instruments, 12/6; telegraphic relays, 6/6.—Below.

HIGHLY Sensitive Button Microphones, mounted in case with two terminals, all new, 2/-; watch type microphones, 2/6; breast plate microphones, with condenser and key switch, 7/6; microphone smoothing condensers, 6d.; microphone transformers, 2/6; 1in. spark coils, fully complete, 6/-; Ford ignition coils, 5/4in. spark, 4/-; 2in. spark coils, 17/6.—Below.

D.C. Electric Motors, all ball bearing and carbon brushes, 1/4 to 1 1/2 h.p., 110 volts, 30/-; ditto, 220 volts, 50/-; 6- and 12-volt car starter motors, 10/-; 1 1/2 h.p. Crompton motors, 220 volts, ring roller bearings, shunt wound, as new, 65/-; 110v. motor blower, 1/2 h.p. motor, 4in. outlets, 45/-; ditto, enclosed, 2in. outlet, 40/-—Below.

DYNAMOS shunt wound for charging or lighting, 50 volts 4 amps., 35/-; 100v. 3a., 45/-; 110v. 3 amp., ball bearing, 55/-; 20v. 8 amp., ball bearing, 30/-; 16v. 11a., 40/-; 100v. 10a., slow speed, £7/10; 75v. 20a., £8/10.—Below.

NEW Shunt Regulators, 100 volts to carry 10 amps., £20/-; other starters and regulators suitable for field rheostats or accumulator charging resistances, 2 amps., 7/6; 5 amps., 10/-; 8 amps., 12/6.—Below.

ALL Above Goods Guaranteed; cash with order or c.o.d.; all goods 3 days' approval from date of delivery; all letters answered.—Galpin, Binfield Heath, near Henley-on-Thames. [9648]

M-L 40-watt Converter 200v. D.C. to 230v. A.C., 50c., new, unused, £8; 6v. Marconi M.C., £2/10; Brown Mascot speaker, £2; 12 new type Hydra 2 mfd., 1/6 each.—10, Queensville Av., Stafford. [9662]

MISCELLANEOUS.

CALIBRATE Your Set with the C.D.E.S. Calibration Chart, 8d., post free.—C.D.E.S., 98, Cherry Orchard Rd., London. [8612]

**OVERSEAS READERS
WE SPECIALISE
IN OVERSEAS
BUSINESS.**

**PARTS, SPEAKERS, ELIMINATORS
OR COMPLETE SETS**

Write and tell us exactly what you require and we will buy it for you. It is our business to select suitable apparatus and thus ensure satisfaction to the user. Payment may be made either through "The Wireless World" deposit system, see page 8, or direct to us.

**THE
OVERSEAS TRADING CO.**
144, St. Vincent Street, GLASGOW,
Scotland.
"Tenacity." Glasgow.
Telegrams

BONA FIDE TRADERS' GUIDE.

Send for our comprehensive Illustrated List. QUICK SERVICE. QUICK SERVICE.

THE QUALITY HOUSE.

PERSEUS MFG. CO., LTD. (Dept. W.W.)
BRANSTONE RD., BURTON-ON-TRENT

METAL CABINETS

for all Wireless World sets from 22/6. Aluminium screening boxes, all sizes, to order. Standard size from stock, 6x6x6 1/2, price 4/- each.

W. H. PARKER, Sheetmetal Workers,
Back Autumn Terrace, Leeds Tel. 52859.

A 2 1/2. Stamp

brings you Post Free a **POLAR TUNING GRAPH** which enables you to record and identify any station by its wavelength.

Dept. "W."
WINGROVE & ROGERS Ltd.
188-9, Strand, London, W.C.2.



POLAR

Electrically sealed
METAL CABINETS

Complete with Base for 1930 Everman Four, New Kilomag Four, and W.W. Record III. Jacobean Finish.

TERMS: CASH WITH ORDER Price 57/6.

RIGBY & WOOLFENDEN, SHEET METAL WORKERS,
MILNROW RD., ROCHDALE.

TILTRACK
Registered Trade Mark
Patent STEEL STORES System

For the Wireless Experimenter, Factory, Factor and Retailer.

Full Particulars from Sole Manufacturer and Patentee:—
BERTRAM THOMAS, Worsley Street, Hulme, MANCHESTER.

Mention of "The Wireless World," when writing to advertisers, will ensure prompt attention.

Miscellaneous.—Contd.

ALEXANDER BLACK,

THE Original Wireless Doctor, will call (London and Home Counties) and cure your set.

CONSULTATIONS by Appointment Without Obligation, sets installed, maintained, and brought up to date, gramophone pick-ups, eliminators, and Webson moving coil speakers demonstrated; purity reproduction specialists.

55, Ebury St., Victoria, S.W.1. Sloane 1655. [0277]

EASY Payments.—We supply, by easy payments, components, accessories, and sets, any make; 10% down, balance spread over 11 months.—Send list of requirements to London Radio Supply Co., 11, Oat Lane, London, E.C.2. [0337]

SCOTT SESSIONS and Co., Great Britain's Radio doctors, officially approved as wireless repairers by Radio Society of Great Britain and Wireless League; old sets of every type repaired, rebuilt, modernised; send set for immediate quotation.

SCOTT SESSIONS and Co.—New sets constructed with your or our components, guaranteed finest workmanship; we specialise in "The Wireless World" circuits; remember, we have satisfied customers throughout the British Isles and in three Continents; if you so desire, we will design and construct high grade apparatus to suit your special circumstances for quality, range and selectivity.—Tel.: Tudor 5326. Muswell Hill, London, N.10. [0262]

COMFORTABLE Digs for Wireless Students Studying in London, good food; very moderate.—Moore, 41, Finborough Rd., South Kensington, S.W.10. Phone: Ken. 1427. [9664]

PATENT AGENTS.

PATENTS and Trade Marks, British and foreign.—Gee and Co. (H. T. P. Gee, Member R.S.G.B. and A.M.I.R.E.), 51-52, Chancery Lane, London, W.C.2. Phone: Holborn 1525. [0001]

REPAIRS.

SCOTT SESSIONS and Co., Great Britain's radio doctors; read advertisement under Miscellaneous column. [0263]

REPAIRS Returned Post Free, and to ensure satisfaction send remittance after approval of same.—Leeds Wireless Repair Service.

LOUD-SPEAKERS, headphones, rewound to any resistance and remagnetised, 3/-; transformers rewound, 4/-; Blue Spots, Triotrons and 4-pole units, 4/6; work guaranteed.—Leeds Wireless Repair Service, 5, Boston Place, Green Rd., Leeds. [9659]

GUARANTEED Repairs by Experts.—Loud-speakers, headphones, cone units, pick-ups, any type, rewound, remagnetised, and adjusted post free 4/-; transformers, from 4/-—Howell, 91, Morley Hill, Enfield, Middlesex. [9555]

WANTED.

ALL Types of Electrical and Wireless Apparatus Purchased for Cash; large quantities only.—T. W. Thompson and Co., 17, Strutton Ground, S.W.1. [0331]

WANTED, A.C. eliminator, 210v. 50 cycles, output 200v. 50 milliamps.—Electrician, Embassy Theatre, Swiss Cottage, London. [9623]

BELL Technical Journal, January, 1929, 0-1 Milli-ammeter.—Dale, 95, Mulgrave St., Liverpool. [9616]

EXCHANGE.

R.I. All-wave Tuner for A.F.5 Transformer; sell 15/-.—Thompson, "Northfield," Yeading Lane, Hayes. [9622]

WE Will Accept Your Surplus Apparatus (making you a high allowance) in part payment for any new apparatus; your enquiry will be dealt with promptly.—Bostock and Stonnill, 1, Westbourne Terrace, S.E.23. [9632]

PANATROPE Mahogany Gramophone Cabinet, purchased from Selfridges; would exchange for walnut, same make.—21, Sturges Av., Hendon, N.W.4. [9631]

COMPONENTS for 6-valve G.E.C. Superhet, frame, oscillators, loading coils, intermediate frequency transformer, and 7 new D.E.3 valves, also 14in. ultra cone chassis; what offers?—Wade, 9, Carlton Rd. Burnley. [9629]

SITUATIONS VACANT.

A MATEUR Constructors Wanted as Agents in A.C. Districts for Eliminator Kits, etc.—Details from Fel-Etric Radio, 56, Garden St., Sheffield. [9258]

WIRELESS Operating; fees payable after appointment; amateur Morse classes.—Manager, Wireless School, 21, Manor Gardens, London, N.7. [9378]

Situations Vacant.—Contd.

SOUND Reproducer Section of the British Thomson-Houston Co., Ltd., requires engineers; applicants must give full particulars of technical training and subsequent experience, especially in connection with talkie equipments.—Apply by letter to Construction Dept., B.T.H. Co., Ltd., Rugby. [9472]

WIRELESS Services.—The premier telegraph college in the British Isles (established 34 years) gives a sound training to all students, with assured positions on qualification; fees are not disguised under expensive board-residence scheme, but are payable by easy instalments, if desired.—Apply for Prospectus, Dept. "W.W.," The London Telegraph Training College, Ltd., Morse House, Earl's Court, S.W.5. [9615]

DRAUGHTSMAN Wanted, capable designing and drawing press tools for radio purposes, etc., must be prepared to take position on South Coast.—Write fully to Box 6265, c/o The Wireless World. [9635]

SITUATIONS WANTED.

JUNIOR Radio Engineer Wanted, S.E. district; state age, experience, salary.—Box 6278, c/o The Wireless World. [9667]

BOOKS, INSTRUCTION, ETC.

FREE: Inventor's Guide on Patents.—T. A. A., 253, (W), Gray's Inn Rd., London, W.C.1. [6373]

TELEVISION.—The complete authorised book on television (Baird Experimental) transmission and receiving, is now ready; order "Television To-day and To-morrow" (Moseley and Barton Chapple), 7/6 net.—Pitman's, Parker St., Kingsway, W.C.2. [9309]

STEP by Step Wireless.—A complete course of instruction for wireless engineers; send 1/- for first 4 weeks.—Clifford Pressland, A.M.I.E.E., Hampton-on-Thames. [0195]

MAKE A GRAMOPHONE AT



quartershop prices. Or buy Cabinets for Wireless. Order Set as shown. British spring motor. Velvet turntable, swan arm, metal soundbox, amplifier, needle cups, for £1 17 3 h.p., and build your own Cabinet. Portable Gramophones from 19/6, postage 1/6. Motors from 8/6. Lists free. 64-pp. Catalogue, Drawing and How to Make Gramophones, 3d.

REGENT FITTINGS CO. (W.O.), 120, Old Street, London, E.C.1

ELEX

T.14 PLUGS & SOCKETS.

Standard Socket 1d. each. Plugs 3d. each, 6 colours. Name Plates, 40 kinds, 1d. each. Write for Hist X102.

J. J. EASTICK & SONS, 118, Bunhill Row, London, E.C.1.



From a recent advertiser's letter:

"I must say your paper is a good advertising agency."

C. R. PEARCE, St. Germans, Cornwall.

W.W.46

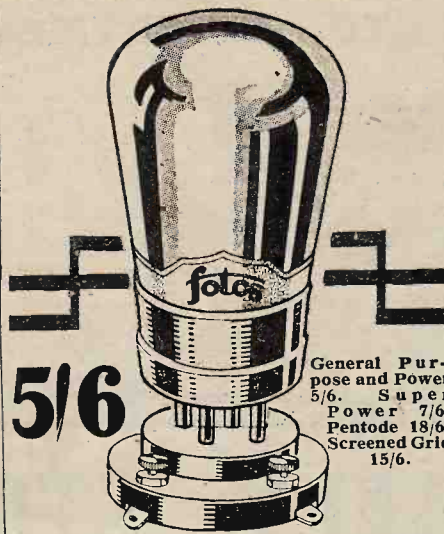

5/6

General Purpose and Power 5/6. Super Power 7/6. Pentode 18/6. Screened Grid 15/6.

Look after your Valves

and your set will look after itself!

Use—in this vital position—the valves that give better and longer reception—



Ask your Dealer or write for descriptive leaflet, B26.

CONCERTON RADIO & ELECTRICAL CO., LTD., 256/7, Bank Chambers, 329, High Holborn, London, W.C.

Telephone: Holborn 8667.



SEND TO-DAY FOR OUR FREE 36-PAGE BOOKLET "SOUND ADVICE."



Super Power Moving Coil Speaker.

The Finest High-grade Speaker in the World

PERFECT RECEPTION FOR MUSIC LOVERS

BAKER'S 'Selhurst'

RADIO WORKS
Office: 89, Selhurst Rd., S. Norwood, S.E.25.
Works: 42, Cherry Orchard Rd., E. Croydon.



EVERY FRIDAY, FOURPENCE

INDEX TO ADVERTISEMENTS.

Abbey Radio	PAGE 7	Gambrell Radio, Ltd.	PAGE 11	Philips Lamps, Ltd.	PAGE 3
Adolph, Fredk.	10	Garnett, Whiteley & Co., Ltd.	9	Player's	7
Appleby, E. Hetherington	8	General Electric Co., Ltd.	Cover iv.	Potter, H. B., & Co., Ltd.	4
B. & J. Wireless Co.	8	Heyberd, F. C., & Co.	10	Radiogramophone Development Co.	7
Baker's "Selhurst" Radio	13	Holzman, L.	Cover i.	Regent Fittings Co.	15
Belling & Lee, Ltd.	12	Hughes, F. A., & Co., Ltd.	Cover i.	Regent Radio Supply Co.	12
Benjamin Electric, Ltd.	12	Jackson Bros.	11	Rigby & Woolfenden	12
Burne-Jones & Co., Ltd. (Magnum)	12	Lisenin Wireless Co.	11	Scientific Supply Stores	8
Celestion, Ltd.	4	London Electric Wire Co. & Smiths, Ltd.	2	Telegraph Condenser Co., Ltd.	12
Cole, E. K., Ltd.	Cover i.	McMichael Lee, Ltd.	12	Thomas, Bertram	12
Concerton Radio & Electrical Co., Ltd.	13	M-L Magneto Synd., Ltd.	2	Transformer Repair Co.	8
Eastick, J. J. & Sons	13	Moore & Co.	12	Varley (Oliver Pell Control, Ltd.)	12
Edison Swan Electric Co., Ltd.	3 & 4 & 6	Mullard Wireless Service Co., Ltd.	Cover i. & 1	Westinghouse Brake & Saxby Signal Co., Ltd.	Cover iii.
Electradix Radios	5	Overseas Trading Co.	12	Wilkins & Wright, Ltd.	12
Electroret Radio Co.	5	Paroussi, E.	12	Wingrove & Rogers, Ltd.	12
Ever Ready Co. (G.B.), Ltd.	Cover ii.	Parker, W. H.	12	Wright & Weaire, Ltd.	Cover iii.
Exact Manf. Co.	5	Perseus Manf. Co., Ltd.	12		
Exide Batteries	5	Partridge & Mee, Ltd.	14		
Fonteyn & Co., Ltd.	12				

PRACTICALLY STRAIGHT!

the primary inductance curve of the



INTERVALVE TRANSFORMER

This new transformer is far in advance of anything similar on the market! Where else do you get this almost perfect inductance ratio—practically a constant! The curve shown demonstrates that the inductance of the primary is within 11% of 85 Henries throughout the range of from 1 to 15 Millijamps. Owing to this constant inductance, all notes are amplified in their true proportions.

Again, owing to the practically constant inductance of the primary under varying D.C. currents, the voltage amplification curve is not affected even when very heavy plate current is flowing—12 to 14 Milliamps can easily be passed without the performance of the Transformer falling off in any way.

Like all PARMEKO components, it is robustly constructed of the very finest materials. It is section wound, and all sections impregnated so that the Transformer will work satisfactorily with voltages up to about 500.

Stocks are held at London and Leicester, or obtainable through your usual retailer. Send a post-card for further details.

Write now for descriptive leaflet of this, and Catalogue of other "PARMEKO" Products.

PARTRIDGE & MEE L^{TD.}

74 NEW OXFORD STREET, LONDON, W.C.1

'Phone : Museum 5070.

26 DOVER STREET, LEICESTER.

'Phone : Leicester 22276.

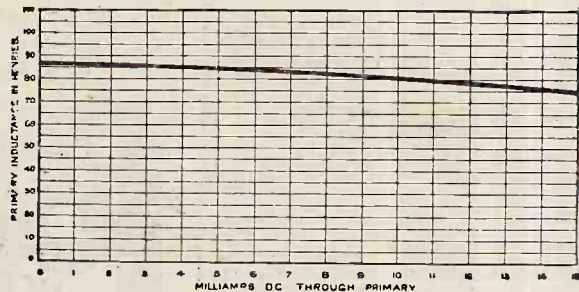

Primary inductance curve.

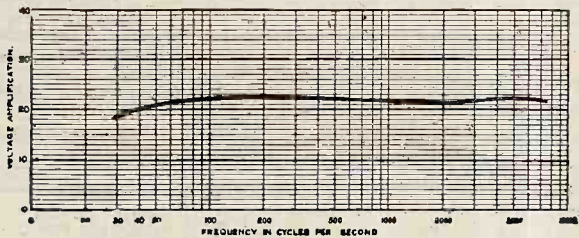

Voltage amplification curve.



Ratio 2 : 1.

PRICE 37'6

Mention of "The Wireless World," when writing to advertisers, will ensure prompt attention

Reliability is essential

This illustration shows a



METAL RECTIFIER

of six kilowatts output, mounted on top of a switchboard and transformer cubicle. Two of these sets are installed in sub-stations operating a large railway power signalling installation. The D.C. outputs are used for the operation of electric point machines, and these rectifiers have been delivering the necessary heavy output efficiently for nearly eighteen months.

The same degree of reliability and efficiency is obtainable from the smaller rectifiers for radio mains equipment.

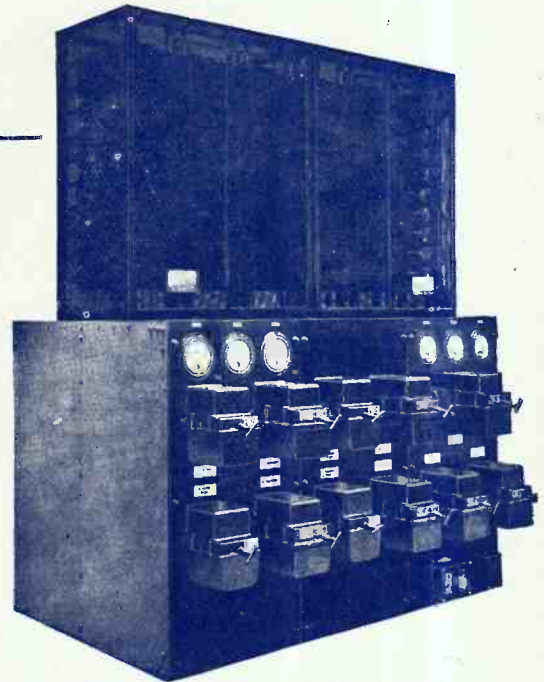

Full details and circuits for all units for radio mains equipment are given in our 32-page booklet, "The All Metal Way—1930." Send 2d. stamp for a copy to
The Westinghouse Brake & Saxby Signal Co., Ltd.
 82, York Road, King's Cross, London, N.1.

RADIO DATA CHARTS

A SERIES OF ABACS

providing most of the essential Data required in Receiver Design

By **R. T. BEATTY, M.A., B.E., D.Sc.**

"Radio Data Charts" provide designers of wireless apparatus with a ready and convenient means of solving problems without having recourse to complicated formulæ and mathematics.

By the use of the charts it is possible to tackle all the more familiar problems in radio receiver design; including, for example, finding the relationship between inductance capacity and frequency, and working out the design of high frequency transformers. All keen amateurs will appreciate this helpful book.

Price 4/6 net. By post 4/10.

From all leading booksellers or direct from the publishers.

Published from the Offices of
"THE WIRELESS WORLD,"

Dorset House, Tudor Street, London, E.C.4.
 W.W.93

GUARANTEED

WEARITE

COMPONENTS

MAINS TRANSFORMERS AND L.F. CHOKES

Type	Output	Use	Price.
T.1	4 v 5 a	For Heaters of A.C. Valves	25/-
T.2	4 v 5 a 5.5 v 2 a 250 v 80 m/a	For H.T. & L.T. For A.C. Valves Also U.5 Type Rectifier	37/6
T.3	135 v 50 m/a	For Westinghouse Rectifiers Styles H.T.3 & H.T.4	27/6
T.4	135 v 50 m/a 4 v 5 a	As T.3 with addition of windings for A.C. Valve Heater	32/6
T.5	230 v 50 m/a 4 v 5 a	For Westinghouse Rectifier Style H.T.1, also A.C. Valve Heater Winding	32/6

Type	CONSTANT INDUCTANCE L.F. CHOKES.			Price.
	Inductance (Henries)	Resistance (Ohms)	Current-carrying capacity	
L.T. 1	0.1	0.5	1.5 amps	18/6
L.T. 2	0.25	1.5	1.0 "	18/6
H.T. 1	10	190	120 m/a	21/-
H.T. 2	20	350	75 "	21/-
H.T. 3	40	850	50 "	21/-
H.T. 4	100	1850	25 "	21/-
H.T. 5	20	400	30 "	12/6
H.T. 6	60	2500	15 "	15/-

Special Transformer for "Orgola" High Power H.T. Supply Unit 30/-
 H.F. By-Pass Unit- 5/-

Write for free illustrated lists:

WRIGHT & WEIRE LTD.,
 740, HIGH ROAD, TOTTENHAM, N.17. Phone: Tottenham 3847/8.



Osram A.C. Mains Valves

The OSRAM M.S. 4 (Screen Grid) for CONTROLLED High Frequency Amplification

EXPERTS know that the true criterion of efficiency in a screen grid valve is *absence of self capacity*—a very high amplification factor alone does not necessarily mean more distant stations.

The OSRAM M.S.4 has the lowest self capacity in circuit of any screen grid valve—only 0.0025 micro-microfarad. This means that, actually, you can get more range on your set because the H.F. amplifier can easily be made perfectly stable.

The OSRAM M.S.4 improves the quality of the local station, due to absence of uncontrolled reaction effects, and makes station searching easy and sure.

PRICE 25/-

Made in England. Sold by all Wireless Dealers.



STABLE
all round the dial!

Characteristics:

Filament Volts	4.0
Filament Current	...	1.0 amp.	approx.	
Amplification Factor	550
Impedance...	500,000 ohms. (at screen volts 60)
Mutual Conductance	1.1
Anode Volts	200 max.

Advt. of The General Electric Co., Ltd., Magnet House, Kingsway, London, W.C.2.

Printed for the Publishers, ILIFFE & SONS LTD., Dorset House, Tudor Street, London, E.C.4, by The Cornwall Press Ltd., Paris Garden, Stamford Street, London, S.E.1.

Colonial and Foreign Agents:
 UNITED STATES—The International News Co., 131, Varick Street, New York. FRANCE—W. H. Smith & Son, 248, Rue Rivoli, Paris; Hachette et Cie, Rue Réaumur, Paris.
 BELGIUM—W. H. Smith & Son, 75, Marche aux Herbes, Brussels. INDIA—A. H. Wheeler & Co., Bombay, Allahabad and Calcutta. SOUTH AFRICA—Central News Agency, Ltd.
 AUSTRALIA—Gordon & Gotch, Ltd., Melbourne (Victoria), Sydney (N.S.W.), Brisbane (Queensland), Adelaide (S.A.), Perth (W.A.), and Launceston (Tasmania).
 CANADA—The American News Co., Ltd., Toronto, Winnipeg, Vancouver, Montreal, Ottawa, St. John, Halifax, Hamilton; Gordon & Gotch, Ltd., Toronto; Imperial News Co., Toronto, Montreal, Winnipeg, Vancouver, Victoria. NEW ZEALAND—Gordon & Gotch, Ltd., Wellington, Auckland, Christchurch and Dunedin.

The Wireless World

4^D

AND RADIO REVIEW

The Paper for Every Wireless Amateur

Wednesday, June 11th, 1930.

BurTON

SELF-LOCATING

VALVE
HOLDER



1/- each

Pentode
-Valve-
Holders
1/6 each

Patent No.
316798

MANUFACTURED BY
C. F. & H. BurTON

PROGRESS WORKS
WALSALL, ENG.



TELSEN
L.F. TRANSFORMERS

Radio's Choice

Have acquired a world-wide reputation for Quality and Value. Built by Specialists in Transformer construction they have set a Quality of Performance above reproach. Your Set will work better with a Telsen Transformer For one now!

Radiogrand 12/6
Ratios 3-1 & 5-1
Radiogram 7-1
Ratio Price 17/6.

TELSEN ELECTRIC
CO. LTD., Miller St.
Birmingham.

VIVIDLY NATURAL RADIO WITH THIS SUPREME SPEAKER



If your set is old or new, large or small, the Ultra Air Chrome Speaker will give you radio with a tmosphere, character, temperament and vitality. Vividly natural, playing, singing or talking, with perfect acoustic balance over the full compass of orchestra and voice From all dealers

50%

ULTRA
AIR CHROME SPEAKER

WITH THE DOUBLE LINEN DIAPHRAGM

ULTRA ELECTRIC LIMITED, 661, HARROW ROAD, LONDON, N.W.13

McMICHAEL PORTABLE RECEIVER

22 GNS.

Point No. 6.

MAINTENANCE.

The magnificent tonal qualities and the immense range of this instrument are obtained with remarkable low running costs.

Hear it at any high-class radio store or our London showrooms.

L. McMICHAEL LTD.,
Wexham Road, Slough, Bucks.
179, Strand, London, W.C.2.



TALKING ABOUT SERVICE

It would be an easy matter for us to say that Hydra condensers will give life-long service; in fact, there is nothing to prevent us from saying they will last for ever. Apart from the ethics involved there is no point in making such remarks because no man who knows anything of condensers would believe us. But what we will say, and say most definitely, is that Hydra condensers have stood up to more than ten years' work with never a sign of a breakdown, and this has happened not once but thousands of times.

The life of a condenser and the service that it will give depend on two very elementary things—the quality of the material used and the skill of the craftsmanship that fashions that material. For over thirty-two years the Hydra organisation has been giving of both the best.



LOUIS HOLZMAN
37, Newman Street, London, W.1.

Telephone : Museum 2641.

Mention of "The Wireless World," when writing to advertisers, will ensure prompt attention

EVERYTHING



ELECTRICAL

IMMENSE POWER WITH PERFECT PURITY

Radio Engineers throughout the world are realising that the true worth of a Power Valve lies in its permissible watts dissipation at the anode, this being a reliable guide to the useful power available to the loudspeaker.

The OSRAM P.X.4 is designed with characteristics so that, with an anode voltage of 200, the undistorted power output hitherto only obtainable by valves in the 400-volt class, is possible. You will not necessarily require all this power all the time, but the use of the OSRAM P.X.4 in the last stage of your A.C. set or radio gramophone means that the sudden loud passages can be handled by the loudspeaker with perfect purity—the piano will sound like a piano, and there will be no “cracked notes.”

OSRAM Power Valves have for years been the choice of experts in sound reproduction.

Characteristics:

Filament Volts	4.0
Filament Current	0.6 amp. approx.
Anode volts	200 max.
Anode dissipation	10 watts max.

PRICE 25/-

Instructions for use are enclosed in each carton.

**OSRAM
P.X.4**
(*Super Power*)
for A.C. Mains
sets & Radio
Gramophones



Osram
A.C. Mains
Valves
FOR ECONOMICAL WIRELESS

MADE IN ENGLAND

Sold by all Wireless Dealers

Advt. of The General Electric Co., Ltd., Magnet House, Kingsway, London, W.C.2.

* * Advertisements for "The Wireless World" are only accepted from firms we believe to be thoroughly reliable.

WINNERS

66P

66P - A BETTER UNIT

More Blue Spot units have been sold throughout the world than of any other make and the opinion of the millions of satisfied Blue Spot listeners is the genesis of the world wide reputation of Blue Spot units and speakers.

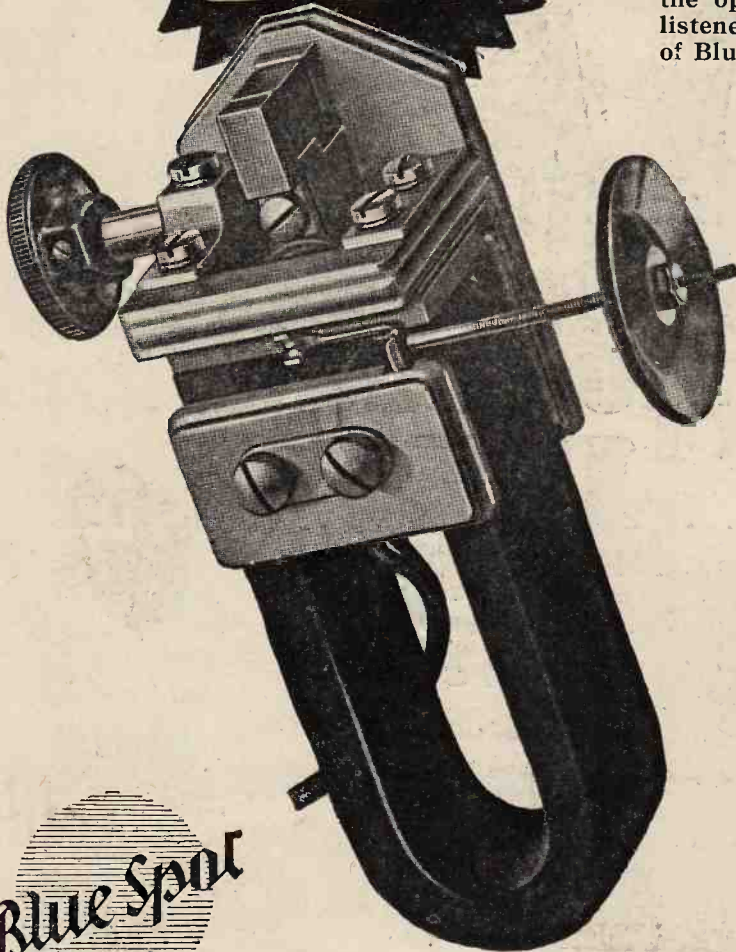

Those who have heard the 66K unit—and it therefore logically follows that they are Blue Spot enthusiasts—must appreciate the obvious difficulty of improving admittedly the foremost unit on the market. It can only be another Blue Spot unit that is an advance on the famous 66K.

Here it is. The new 66P unit! It is the logical development of the famous 66K unit and in its manufacture proved technical principles and extensive practical experience are incorporated, resulting in a unit which approaches perfection. Owing to the special improved details in design, covered by various patents and obtainable only in Blue Spot products, this unit will give remarkable results.

An entirely new method of moving the anchor between the four poles has been adopted and the precision of adjustment is so keen that it is now possible practically to place the anchor on the exact distance from the poles as is theoretically necessary to obtain the best effects as yielded by a magnetic unit under the best conditions.

The noticeable result of this increased sensitivity is the larger range of frequencies obtainable. In addition to the powerful reproduction of the bass register with its full beauty, the higher frequencies which largely determine the character of speech and music are also reproduced faithfully.



TRADE MARK

Blue Spot Power Unit Type 66P ..	27/6
Blue Spot Major Chassis Type 37P..	15/-
Blue Spot Special Chassis Type 31P ..	10/6
Blue Spot Minor Chassis Type 28P..	9/-
Permissible D.C. Current ..	30 m/a
D.C. Resistance	1,000 ohms

F. A. HUGHES & CO., LIMITED

Mention of "The Wireless World," when writing to advertisers, will ensure prompt attention.

FROM THE START

66R-BLUE SPOT'S MASTERPIECE

66R

Improved receivers and valves have necessitated the production of a new and better loud speaker unit capable of handling enormous outputs without in any way detracting from the Blue Spot standard of reproduction.

The new Blue Spot Power Unit type 66R will handle enormous outputs without distortion or rattle, and in this respect the advantage of the patented adjustment obtainable only in Blue Spot products is appreciated more than ever. The powerful electric energies acting upon the anchor, energies that converted into acoustic frequencies cause at the bass notes even a sensible vibration of the furniture and the floor, would wear out by friction any link or weak construction of the part supporting the anchor. The patented adjustment of the Blue Spot Unit will never wear out, but will work with just the same exact precision as on its first day.

This is one of the advantages that guarantee you the wonderful brilliance and volume of this Blue Spot Unit. The 66R Unit stands a triumphant tribute to the painstaking care and ingenuity of the Blue Spot designers.

- Blue Spot Power Unit
- Type 66R ... 35/-
- Blue Spot Major Chassis
- Type 37R ... 15/-
- Blue Spot Special
- Chassis Type 31R ... 10/6
- Permissible D.C.
- Current ... 50 m/a
- D.C. Resistance ... 500 chms.

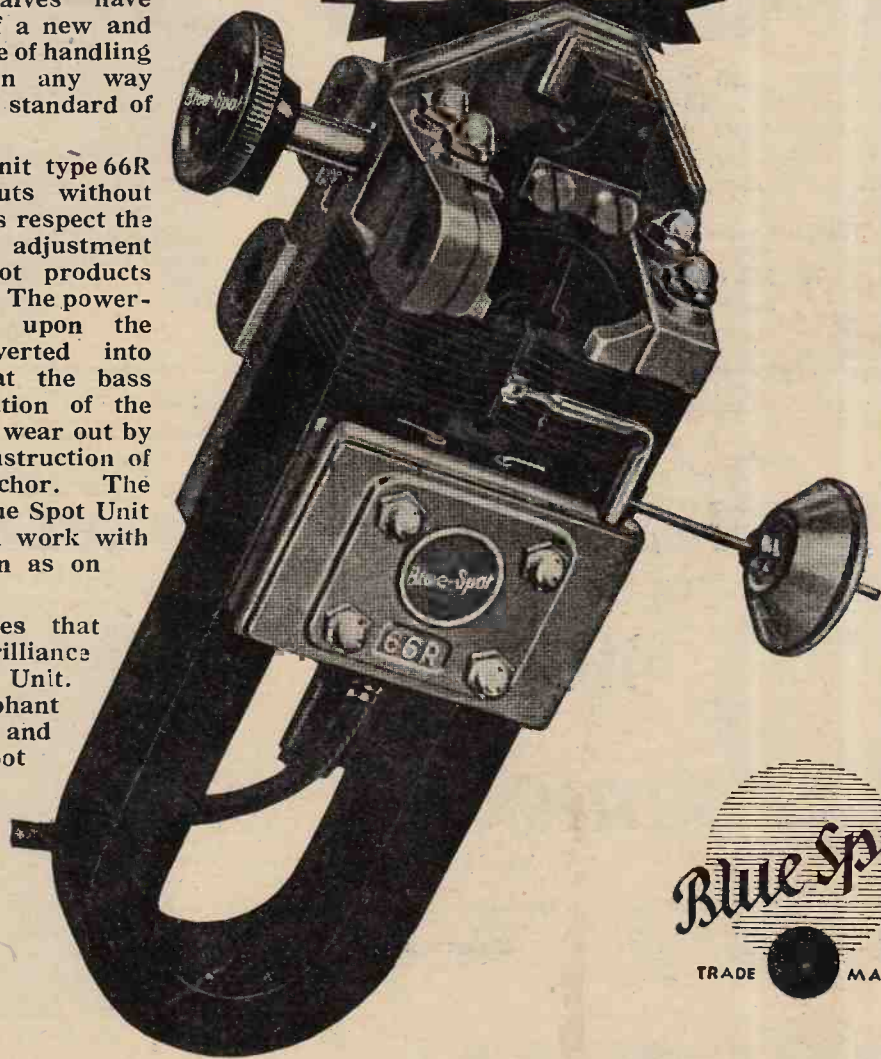

204-206 GREAT PORTLAND STREET . . . LONDON, W.1.

Phone: Museum 8630 (4 lines)
 Distributors for Northern England, Scotland and North Wales: H. C. RAWSON (Sheffield and London), Ltd., 100, London Road, Sheffield (Phone: Sheffield 26006) and 22, St. Mary's Parsonage, Manchester (Phone: Manchester City 3329).

D.C. to A.C.

If your supply mains are D.C. you can operate an A.C. All-Electric Receiver by using the



**D.C. to A.C.
ROTARY
TRANSFORMER**

Can be supplied to run from any voltage 12-250 V.D.C. 40 watt model £13; 85 watt model £19. Recommended and used by Philips Radio, Marconiphone, Burndep, Kolster-Brandes, M.P.A., Etc., Etc.

Write for Pamphlet 596/1 which gives full details

THE M-L MAGNETO SYND. LTD.,
Radio Dept., COVENTRY.

Telephone : 5001.



Godbolds

*Weston sets the
world's
standard*

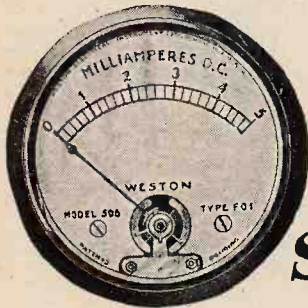

Our Model 506 MIL-AMMETER Panel Mounting type should be placed in the High Tension Circuit of the valve to ensure correct operation and to check distortion.

Prices £1 : 15 : 0—£2 : 15 : 0

WESTON
STANDARD THE WORLD OVER

Pioneers since 1888

WESTON ELECTRICAL INSTRUMENT CO., LTD.,
15, Great Saffron Hill, London, E.C.4.

A3

**"LION"
PORTABLE RADIO**
QUALITY
FIRST CONSIDERATION.



17
GNS.
Complete

*Including
All
Accessories
and
Royalty
and
Fully
Guaranteed*

UNSURPASSED
in Design, Workmanship and Finish with Perfect Simplicity of Control, giving an amazingly true Musical Performance, combined with Long Range & Selectivity.
MUST BE SEEN AND HEARD TO BE APPRECIATED.

Write for full illustrated pamphlet and ask for free demonstration.

HOLT & CROMPTON - 196, Shaftesbury Avenue - W.C.2

Temple Bar 5073.

AGENTS IN LONDON, SOUTH COAST AND MIDLANDS.

Mention of "The Wireless World," when writing to advertisers, will ensure prompt attention.

A4

Run your Portable from the Electric supply

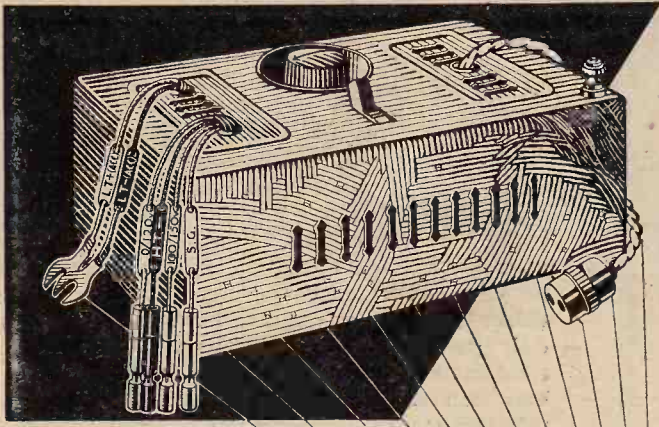

by connecting this New "Ekco" Unit

NO BATTERIES
ACCUMULATORS NOW
ALWAYS ON CHARGE

All you have to do is done in three minutes—Slip the "EKCO" ALL-POWER UNIT into the space previously occupied by your battery—connect your battery and accumulator leads to the "EKCO" Unit Terminals—plug the "EKCO" Adaptor into any electric light or power socket... and then, switch-on—that's all!

Specially designed to FIT SNUGLY in any portable, but also for use with all types of sets from one to five valves consuming up to 20 m/a. Constant power—no hum—negligible upkeep costs—lasts a lifetime.

British Made for D.C. and A.C. Mains. Westinghouse metal rectifier—flexible output leads and variable output tapping in A.C. Models.

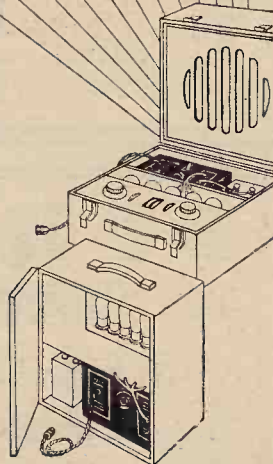

Model C.P.1. for A.C. Mains combines Trickle Charger and H.T. unit. Tappings: S.G.; 0-120; 120/150 volts (100 volts only, if required) £6. 0. 0.

Model 1V.20 for A.C. Mains. Tappings: S.G.; 0-120; 120/150 volts (100 volts only, if required) £4. 12. 6.

Model 1V.20 for D.C. Mains. Tappings: S.G.; 0-120; 120/150 volts. £2. 10. 0.



POWER SUPPLY UNITS for PORTABLES



Obtainable on Easy Payments. Write for NEW illustrated literature!
E. K. Cole, Ltd., Dept. W, "Ekco" Works, Leigh-on-Sea.

Just plug in—that's all!

318

A.5

Advertisements for "The Wireless World" are only accepted from firms we believe to be thoroughly reliable.

MULTI-VOLT TRANSFORMERS BY VARLEY

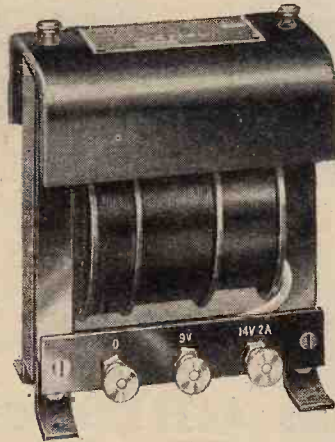

"Multi-volt Transformers are the natural outcome of VARLEY specialised experience." This was a spontaneous statement by one of the leading figures in the electrical and radio industry of the British Isles. This man knew VARLEY activities for many long years and—he expected VARLEY to make multi-volt Transformers

VARLEY has produced a range of Multi-volt Transformers and they have been a great success. Every detail of design has been given special attention, yet this care and skill has not affected the price. They represent real economy.

Whether you decide to use Westinghouse Metal Rectifiers, Igranic-Elkon Metal Rectifiers or Valve Rectifiers—whether for H.T. supply only, L.T. supply only, or both together—Varley makes them all, and each is a master of its class.

Write for Section E. of our 1929/30 Catalogue for full particulars.

E.P. 6. For Westinghouse Metal Rectifiers (50 Watts) £2 : 5

E.P. 7. For Valve Rectifiers (50 Watts) £2 : 10

E.P. 8. For Valve Rectifiers (120 Watts) £3 : 10



Advertisement of Oliver Bell Control Ltd., Kingsway House, 103, Kingsway, London, W.C.2. Telephone: Holborn 5303.



Pat. No. 322907

TRIX SCREENED GRID 4

Full details from the manufacturers:
ERIC J. LEVER (TRIX) LTD.
8/9, Clerkenwell Green, London, E.C.1.
Phone: Clerkenwell 3014/5.

22 GNS.
Including Royalties.

THE Selectivity SET

with the exclusive
patented
features!

An adaptor enables the user to plug-in a connection for an H.T. Eliminator — automatically cutting out the internal battery. Upright type solid walnut hand-polished cabinet, fitted with turntable. Control panel at top for ease of tuning. Volume control. Plug for trickle charger and gramophone pick-up.



THERE is no better method of purchase than purchase by Part Exchange through a service properly conducted. It will be definitely to your advantage to utilise the radio part exchange and banking facilities offered in the name of Appleby. Thousands of your fellow readers do, and have done for years. Part exchange credit notes worth thousands of pounds have been duly honoured upon presentation. Not a single item of customers' property has ever been lost or mislaid. Particulars of this part exchange service, the first and largest in existence, will be forwarded upon request to The Secretary,

Appleby's
CHAPEL STREET, MARYLEBONE,
LONDON.

Paillard— ELECTRIC INDUCTION MOTOR

For alternating current only.
100 to 130 or 200 to 250 volts.
7 3/4 in. x 5 1/2 in. x 5 1/2 in.

Ideal for Radiograms.

NO INTERFERENCE. No Belt. No Brushes or commutator. Perfectly silent and no variation in speed of revolution, even with considerable fluctuation in mains voltage. Fitted by leading Radiogramophone Makers. Equipped with 12-inch Turntable, covered with velvet and Automatic Brake and Cut Out.

£4.17.6 (Without Unit Plate £4.10.0)

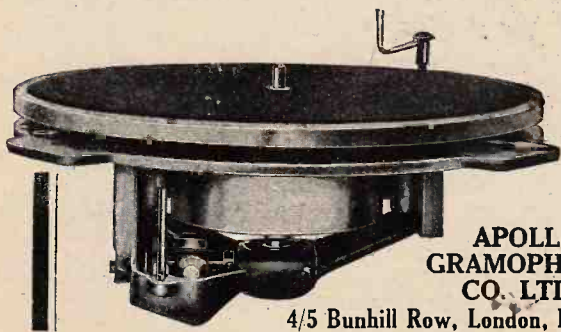

**APOLLO
GRAMOPHONE
CO. LTD.,**

4/5 Bunhill Row, London, E.C.1.

DONOTONE THE BEST LOUD SPEAKER

INTRODUCING THE NEW IDEAL MODEL

The patented tuned gongs absorb all unwanted resonances, and the special diaphragm, built in layers, imparts to this Speaker a tone which is amazing in its purity and also gives a marked increase in volume.

COME AND HEAR IT!

Price 6 GNS.

DEMONSTRATIONS DAILY.

THE DONOTONE (Regd.) LOUD SPEAKER
Dept. W, 40, Farnival Street, Holborn, London, E.C.4

Phone: HOLBORN 0523.

Mention of "The Wireless World," when writing to advertisers, will ensure prompt attention.



ALL POSITION NON-SPILLABLE



*The Original
Jelly Acid
Battery.*

The Perfect Battery for all Portables

It is only natural that the C.A.V. Jelly Acid Battery should have its imitators. It is a compliment that reflects the marvellous success of a battery already standardised in many popular portable sets, and which is invariably recommended in the constructional articles of the Wireless Press.

The preparation of the special C.A.V. Jelly Acid remains the secret of our chemists, however, and is not to be found in any other battery. Its use in conjunction with the special container provides a battery which is the lightest and most compact obtainable. It gives maximum capacity in any position, and is absolutely unspillable. It is the battery for *your* portable set.

Our latest Radio Battery Catalogue No. H4 will gladly be forwarded on application.



C.A.V. Vandervell & Co. Ltd.
ACTON, LONDON, W.3

C.A.V. H.T. Accumulator

We shall be glad to send you particulars of the C.A.V. H.T. Accumulator supplied in 10 volt units or 30 volt groups of 2,500, 5,000 and 10,000 milliamp hours capacity. This entirely new and original H.T. is suitable for all classes of Receivers.

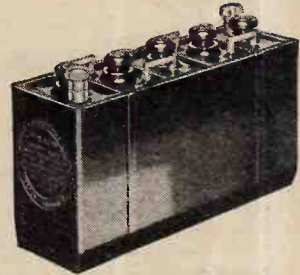

EDISON BELL RADIO

Pick-up & Arm

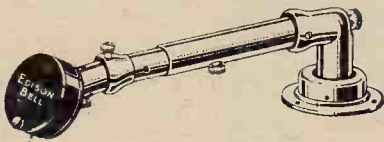

THE Edison Bell Pick-up is the outcome of intensive research which had as its objective the production of an electrical reproducer which would have extreme sensitivity at all frequencies with a rising characteristic towards the lower frequencies permitting emphasis of the bass notes, lightness and freedom from record wearing tendencies.

The model illustrated embodies all these desirable features and a glance at the response curve, as published by "The Wireless World" from their own observations, will clearly show the excellence of this instrument's performance.

Cat. No. 407. Complete with Arm and Rest in nickel or gilt finish. PRICE 37/6

Full details: EDISON BELL LTD.,
Glengall Road, London, S.E.15.

5-Valve De Luxe PICNIC PORTABLE



THE Picnic Portable was designed to be a companion all the year round—in the home—when motoring—up the river—touring, etc., etc. It is soundly constructed and contains five valves, 2 H.F., Detector, and 2 L.F., in blue leatherola Cabinet. Total weight 26 lbs.

Complete with Mullard Valves, H.T.,
Non-spill L.T., & new type Cone Speaker.

De Luxe Model:
£17-17-0

Including Royalties.

THE NEW NOVOTONE COMPENSATOR

For use with Pick-ups having a High Impedance.

THE STANDARD NOVOTONE was designed to suit the majority of pick-ups obtainable, but, lately, customers have enquired whether we had one suitable for use with the "Marconi" pick-up.

THE NEW TYPE "H" NOVOTONE, which has been specially designed by Dr. McLachlan, meets this demand and is recommended for use with all pickups having a high impedance.

PRODUCTION IS IN FULL SWING.
ORDER NOW. IMMEDIATE DELIVERY.

Only the Novotone gives Perfect Compensation.

REALISM FROM RECORDS

is an accomplished fact only when you use the
NOVOTONE COMPENSATOR

Pick-up users should send p.c. for 16-page "Novotone" Book—Free.

GAMBRELL RADIO LTD.
6, Buckingham Street, Strand, London, W.C.2.

The New TYPE "H"

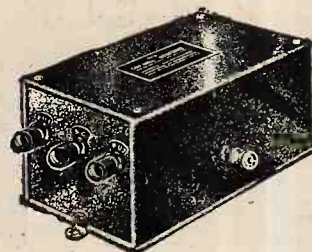

NOVOTONE

For High Impedance
Pick-ups.

TYPE "H"

Blue finish case, £5

STANDARD

Black finish case, £5

From Dealers or direct.

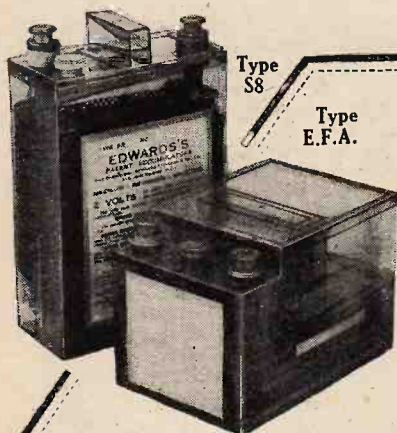

FREE ACID ALWAYS

THE
FEATURE OF
EDWARDS'
ACCUMULATORS

To ensure free circulation of acid we use perforated ebonite separators, NOT glass-wood, wood or jelly. There is no possibility of acid creeping through vent and there is no corrosion of terminals.

Filler Caps are not removed when charging, consequently the case is always clean and dry.

UPRIGHT TYPE: Made specially for cabinet type receivers. Even if knocked over acid cannot escape.

ATTACHE CASE TYPE: Made specially for attache case portables. **NON-SPILLING IN ANY POSITION.**

QUALITY ACCUMULATORS OF GOOD REPUTE

Made to fit any set, upright or attache case.

ROWLAND EDWARDS & CO., LTD.,
317, HIGH HOLBORN, W.C.1. Phone: Hol. 1331.

We Regret the Delay in deliveries of the R.G.D. Radiogramophone



during our removal to larger and more modern works, and beg to say that all orders can now be dealt with speedily from our new address.

The All Electric R.G.D. Radiogramophone for A.C. or D.C. mains with coil-driven speaker.

Mahogany Oak
£80 £75

We shall be pleased to supply literature on application.

The Radiogramophone Development Co.
72, MOOR STREET, BIRMINGHAM.

Mention of "The Wireless World," when writing to advertisers, will ensure prompt attention.

"TILTRACK"

Registered Trade Mark
Patent STEEL STORES System

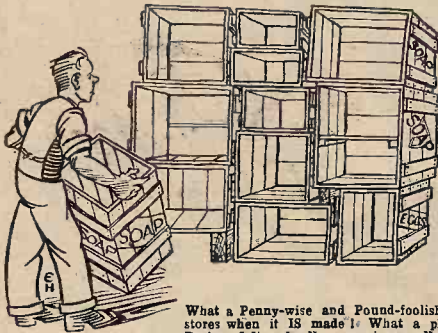

Are
YOUR
Stores
made
from
Soap-
boxes?

What a Penny-wise and Pound-foolish proceeding! What a stores when it is made! What a place to lose goods in! Dark and dismal. No convenience. No method. No efficiency. What a difference with "TILTRACKS." All Steel. Goods found instantly. Trays tilted to give maximum illumination and rapid removal of goods. They save many pounds per year—to say nothing of the conservation of temper and energy.

"TILTRACKS" ARE MADE IN MANY STYLES: For the Experimenter, The Factor, and The Manufacturer. Send to-day for Lists.

THE "BENCHRACK" (Tiltrack Principle)

A real help for storing small parts such as Terminals, Nuts, Washers Insulators, etc. Made to stand on the work bench, it enables all small parts needed for the job in progress to be stored where they are immediately to hand. All the trays are tilted so that the parts stored can be seen at a glance, and the front faces of the trays are rounded so that the smallest parts can be swept up the slope with the fingers of one hand. Each tray is provided with patent hinging partitions which can be moved quickly to make larger or smaller compartments. Being so accessible these racks greatly facilitate stocktaking. The Experimenter will do his jobs much quicker and with greater pleasure, and the Factory will save many pounds per year by installing this Benchrack.

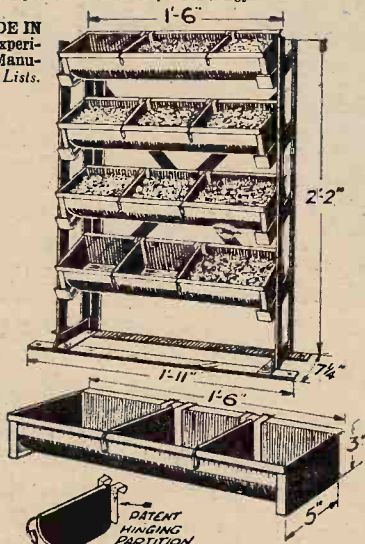

30/- F.O.R.

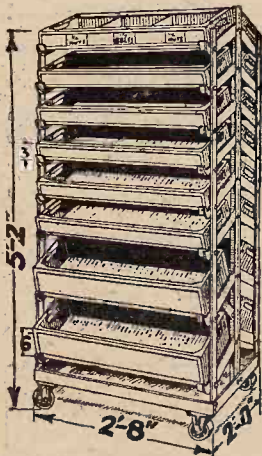

"TILTRACK" WHEELED TRUCK

It wheels to the job. A big time saver.

Particulars from Manufacturer and Patent

BERTRAM THOMAS, Worsley Street, Hulme, MANCHESTER.
London Office and Showroom:—28, Victoria Street, S.W.1.



"TILTRACK" (Senior)

For storing all kinds of goods. Approx. size of Trays, 2' 6" x 12" x 6".

MUSIC ANYWHERE from ANYWHERE



DESIGNED and made with the same meticulous care and on the same principles as all Philips' products, this Portable Set embodies several distinct features, each marking a definite step forward in the history of modern radio. The simple, almost severe, design of the cabinet enables it to harmonise with any type of furniture, while the aerial, speaker, and batteries are all contained in the cabinet, leaving no unsightly wires to spoil its appearance. A single thumb control actuates two tuning circuits, which ensures easy reception of the leading British and Continental stations. Even the controls are out of sight when the set is not in use.

When the cabinet is closed the receiver is automatically switched off and cannot be used again until the operating panel is unlocked.

For Summer Radio Philips Portable, Type 2522, Price £27.10.0 or on convenient easy payment terms.

MORE THAN A PORTABLE A PHILIPS PORTABLE

Made by the manufacturers of the famous Philips Argenta electric lamps, all-electric radio receivers, commercial and industrial fittings, and neon signs.

PHILIPS LAMPS LTD., Philips House, 145, Charing Cross Road, London, W.C.2.

Arks SC.11.

A HIGHER CONDUCTANCE MUTUAL THAN ANY OTHER BATTERY-HEATED POWER VALVE.



**P. 240
PRICE
15/-**

With Mazda valves in all positions your set will give a performance many times better than before.

The Amazing

MAZDA RADIO VALVES

For a given type of valve the higher its amplification factor and the lower its impedance the better the performance which can be expected of it. The Mazda P.240 has the highest magnification factor for its impedance of any 2-volt power valve. This quality is expressed as mutual conductance and the higher the mutual conductance figures the better the valve.

It can therefore be truthfully claimed that the P.240 is the finest 2-volt power valve on the market—without exception.

THESE FIGURES PROVE IT . . .

Amplification Factor	-	-	-	7
Anode A.C. Resistance (ohms)	-	-	-	1,900
Mutual A.C. Conductance (MA/V)	-	-	-	3.7



THE EDISON SWAN ELECTRIC CO., LTD.,
Radio Division,
1a, Newman Street, Oxford Street, W.1.
Showrooms in all the Principal Towns.

EDISWAN

7.51.

Mention of "The Wireless World," when writing to advertisers, will ensure prompt attention.

A10

The Wireless World

AND
RADIO REVIEW
(18th Year of Publication)

No. 563.

WEDNESDAY, JUNE 11TH, 1930.

VOL. XXVI. No. 24.

Editor: HUGH S. POCOCK.
Assistant Editor: F. H. HAYNES.
Editorial Offices: 116-117, FLEET STREET, LONDON, E.C.4
Editorial Telephone: City 9472 (5 lines).
Advertising and Publishing Offices:
DORSET HOUSE, TUDOR STREET, LONDON, E.C.4.
Telephone: City 2847 (13 lines). Telegrams: "Ethaworld, Fleet, London."
COVENTRY: Hertford Street.
Telegrams: "Cyclist, Coventry." Telephone: 5210 Coventry.
BIRMINGHAM: Guildhall Buildings, Navigation Street.
Telegrams: "Autopress, Birmingham." Telephone: 2970 and 2971 Midland.
MANCHESTER: 260, Deansgate.
Telegrams: "Iliffe, Manchester." Telephone: 8970 City (4 lines).
GLASGOW: 101, St. Vincent Street, C.2.
Telegrams: "Iliffe, Glasgow." Telephone: Central 4857.
PUBLISHED WEEKLY.
Subscription Rates: Home, £1 1s. 8d.; Canada, £1 1s. 8d.;
other countries abroad, £1 3s. 10d. per annum.
Entered as Second Class Matter at New York, N.Y.
As many of the circuits and apparatus described in these pages are covered by patents, readers are advised, before making use of them, to satisfy themselves that they would not be infringing patents.

CONTENTS OF THIS ISSUE.

	PAGE
EDITORIAL VIEWS	597
PRESENT-DAY PORTABLES	598
HINTS AND TIPS FOR PORTABLE USERS	602
BUYERS' GUIDE TO 1930 PORTABLE SETS	604
THE PORTABLE OF 2030. BY N. P. VINCER-MINTER	620
REPRESENTATIVE PORTABLES REVIEWED	623
CURRENT TOPICS	628
LABORATORY TESTS ON PORTABLE ACCESSORIES	630
CORRESPONDENCE	633
BROADCAST BREVITIES	635
READERS' PROBLEMS	636

FOUR YEARS OF PORTABLES.

THERE were some who despised 'portables,' and others who visualised them as the only acceptable form of wireless receiver. Less than four years ago the enthusiast regarded the portable as a receiver in which the desirable conditions for good performance had necessarily been sacrificed, while, on the other hand, the convenient form of the portable made a strong appeal to those less exacting. But our views change.

Thinking of holidays reminds us of the need for a portable, and it is now rather the hardened old-timer loathe to leave his listening entirely behind who is the first to support the suggestion of taking a set. Portable-set performance has changed vastly in the course of a brief career. Scarcely any other factor than the enormous improvements which have been made in the valve is responsible for this progress. With valve goodness directly related to the amount of current passed by the filament, which, in turn, controls the weight and bulk of a set, we at once appreciate the well-founded

reasoning by which the portables of old were condemned. No further attempts are now made to reduce filament current accepting a certain minimum beyond which there is no need to go, valve performance having been brought up to a standard far beyond anticipation. Until comparatively recently an H.F. amplification of ten times for a single stage, giving, it was hoped, a hundred times magnification in respect of two tuned stages, was considered to be high. Even this value for H.F. amplification could not be applied to the portable owing to the need for three tuning controls, a critical adjustment of neutralising and generous screening. Tuning on two wave ranges made the use of the two neutralised stages unworkable.

Tuned Stage Replaces Aperiodic Amplifier.

Thus, the aperiodic H.F. amplifier formed the basis of portable-set design and, perhaps, not without distress to the enthusiast, gave such good results that the portable established itself as a useful receiver. The aperiodic amplifier provided little more than two circuits in a threshold condition of regeneration, and set sensitiveness was, no doubt, entirely the result of reaction. In the portables of to-day we find the screen-grid amplifier giving considerable H.F. amplification with stability, and providing a tuned circuit readily adjustable to the two wave ranges.

Now, the listener views the portable as his ideal receiver in that it is self contained, of compact and pleasing appearance, and ready for use anywhere. In achieving these desirable features the set has, nevertheless, been designed to be reliable and modest in cost of upkeep.

Combining Portable and All-mains Set.

While we have sometimes wondered why the portable is purely a British production, the reason for its popularity is to be found in an early appreciation of the need for a self-contained set. As to its future, some doubt has been expressed owing to the rapid growth of the all-mains-operated receiver. On this point, however, we would say, first, that the portable is the only set of equivalent utility when mains are not available, and secondly, that the distinction between portable and all-mains receiver is likely to go. Looking through the collection of technical data and set specifications given in the following pages, we see that portable-set design has consolidated itself, except in respect of one feature, where we find the beginnings of the all-mains portable convertible or adaptable from battery to mains operation.



HAS portable receiver design advanced during the past year, and are the portables offered to-day appreciably better than their predecessors? To answer this question it has been necessary to scrutinise the specifications of some seventy sets. In addition, reception tests with half a dozen sets considered to be representative of the various types served to demonstrate, by comparison with older models, the benefit bestowed by this season's revised designs. Without proceeding further in our investigation, the answer to the question becomes obvious. There has been no drastic change in principle, few innovations, neither is performance markedly better. These findings do not signify stagnation in portable set production, but indicate a stability which, though perhaps rare in radio, is an accepted condition when reliability is reached. Incidentally, the position of the portable is that it is as popular to-day as previously.

To explain this we must take into account that the high-powered stations of the regional scheme enormously increase the area of reliable reception, while the vogue of the self-contained set, typified also in the all-mains receiver, will stay. Mains sets will rival the portable, but rather than the one type eclipsing the other, it is safer to say that the line of demarcation will be less definite. Herein is the most important development—self-contained sets externally following the portable and transportable types, yet fitted or adapted for all-mains working. Whereas last year no example existed of an all-mains operated portable, at least four models are to be found among the portable set specifications. On the border line we have the partially mains-operated set in which the H.T. battery has been replaced by an H.T. eliminator of equivalent dimensions. Such a modification removes the outstanding drawback in the way of quality reception with the portable, that of the limitation in H.T. potential and current supply. One can predict the production of the all-mains portable, compact and convenient to transport and operate, and arranged by simple adjustment for use with any supply voltage.

An analysis of the actual circuit arrangement does

not support the hope of a radical change predicted two years ago, and emphasised again in our review of last year. A figure, amounting to no less than 65 per cent., represents the number of aperiodic H.F. couplings as a part of the total H.F. stages in all the sets scrutinised. It was forecast that a decline in the use of H.F. aperiodic couplings would come about, and although the figures confirm this, the change is slow. It is, perhaps, a misnomer to term the aperiodic H.F. stage an amplifier, as the H.F. amplification which might be provided by the valve and associated coupling is prevented from occurring owing to the presence of the anode to grid capacity. In a few instances, screen-grid valves have found their way into aperiodic-coupled stages, and while this arrangement removes the out of phase anode to grid coupling, which tends to nullify the signal voltage on the grid amplification, is, nevertheless, limited by

virtue of the relation between valve and anode-circuit resistance. Five-valve sets with two simple aperiodic H.F. stages still remain in large numbers, and their station-getting properties are no doubt due to the benefits bestowed by critical adjustment of incidental and intentional reaction. In testing receivers, it is interesting to observe

that those models fitted with a tuned H.F. stage will function when the reaction coupling is at zero, while the set with two aperiodic H.F. couplings is, as a rule, absolutely silent, even when near a broadcasting station, unless reaction is applied.

There is, therefore, an increasing use of the single-tuned stage associated with the screen-grid valve, and good performance is invariably obtained from sets so fitted. In confirmation of this observation, the charts clearly reveal the following changes: (1) A large increase in the number of four-valve sets with a corresponding decline in the five-valve class; (2) A doubling of the percentage figure representing the use of screened valves; (3) An increase in the number of two-dial sets; (4) The introduction of ganged tuning; (5) The more generous use of screening; (6) An increase from 8 to 72 per cent. for tuned good H.F. amplifiers, which includes the single H.F. stage sets. These tuned single

THERE is no better guide to the best than an analysis of the features to be found in all. By a comparison of present-day practice in portable design with that of previous years we see both the innovations and the trend so that those details which make a set "modern" are clearly revealed. Portables have not changed to any great extent this season but the increase in the use of the tuned H.F. stage in place of the all-aperiodic amplifier is significant. Most important is the combining of the portable and the all-mains set.

PORTABLE SETS of 1930

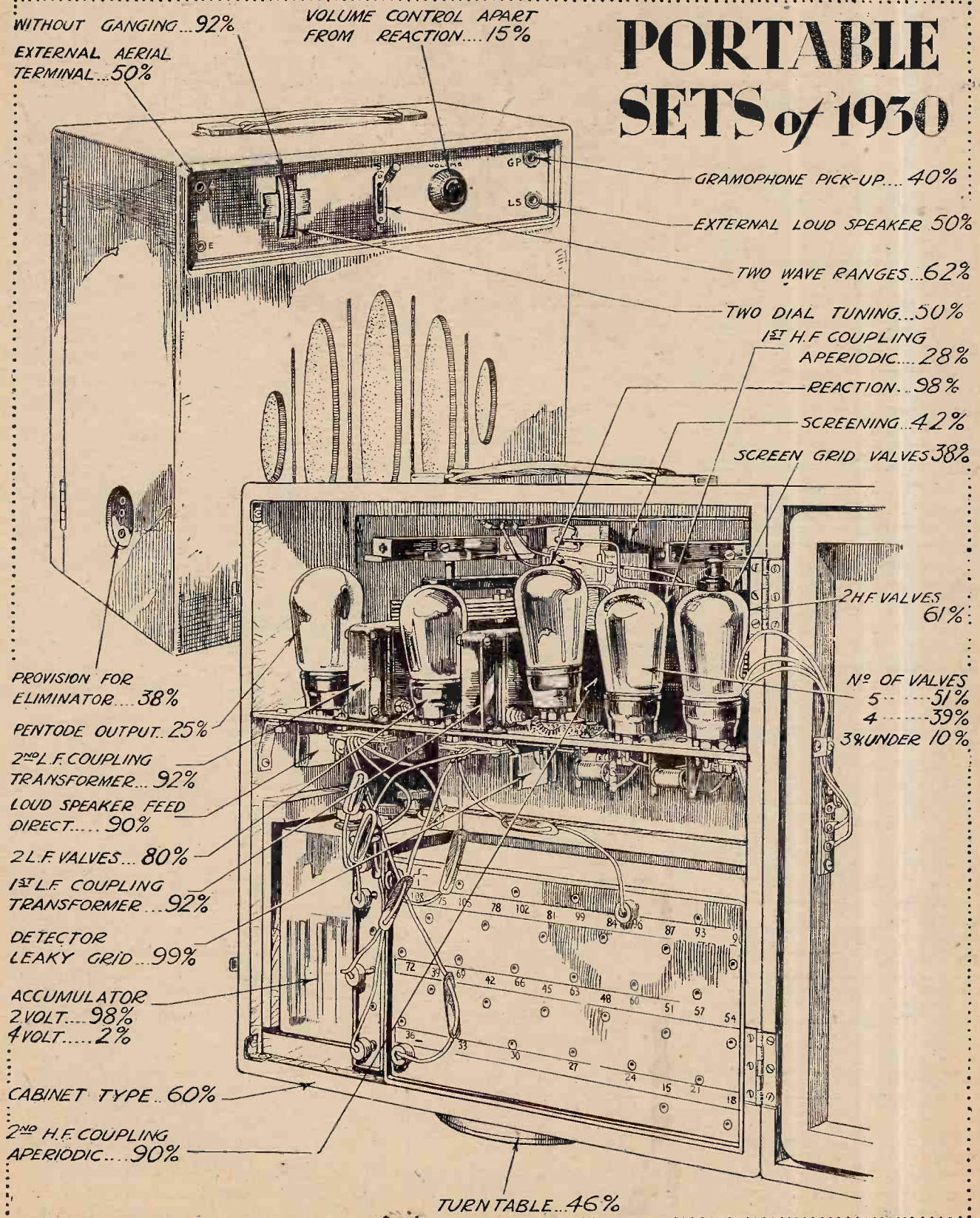

Present-day Portables.—

stage H.F. sets give better amplification when the long-wave coils are switched into circuit, a condition only to be expected as a result of the improved performance of the tuned circuit.

Increased H.F. amplification has not brought about a change in the methods of detection, and the anode-

rotating coil in place of the fixed winding and capacity feed-back.

Coming to the L.F. stages, a decline is found in the use of resistance coupling, for reason of its low-stage gain, the limited value of H.T. available, and the fact that by its use there may be a tendency to accentuate the bass frequencies. This last circumstance is all-

important, as it is the bass frequencies that bring about the overloading of the meagre output valves normally used in portables. Quality can be quite good with the portable, providing the generous grid swings of the bass are partially rejected in the L.F. amplifier, while by the use of a suitable loud speaker a uniform frequency response level can be restored to a satisfactory extent.

An important change coming about in the output stage is the increase in the use of the pentode. For a given consumption of H.T. current at the restricted H.T. potential of the bat-

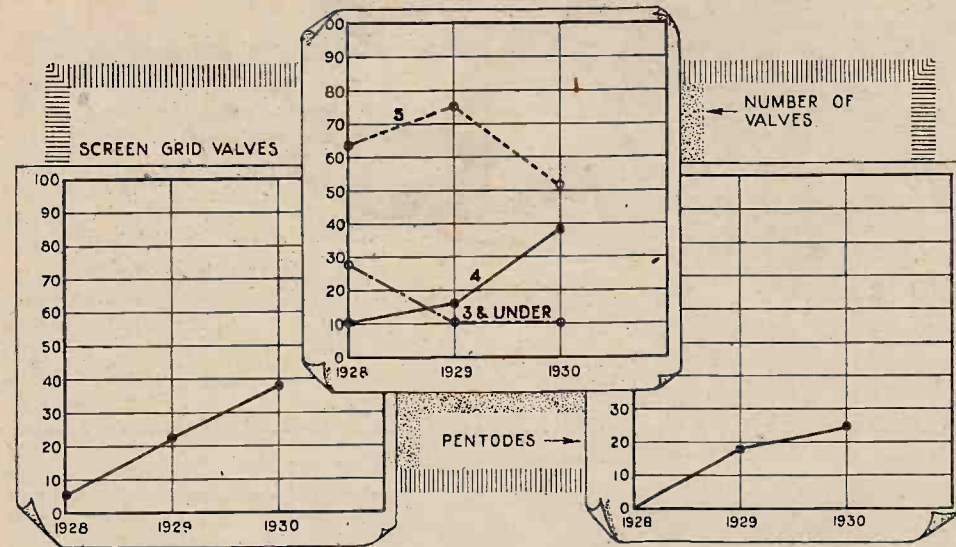

tery-operated portable, the pentode gives an appreciably greater power output than the triode, and no longer can it be asserted that the requirements for quality reproduction cannot be satisfactorily maintained. Manufacturers hesitate in the adoption of the pentode because as a single-stage L.F. amplifier it is considered inadequate for distant station reception, and

the bend method is still practically non-existent. Leaky grid is universally used and, as far as can be ascertained, normal values of condenser and leak are adopted in every instance. The evidence of fading is largely removed by the use of the leaky-grid detector. Were a figure given in respect of the methods of reaction coupling, we should find a small increase in the use of the

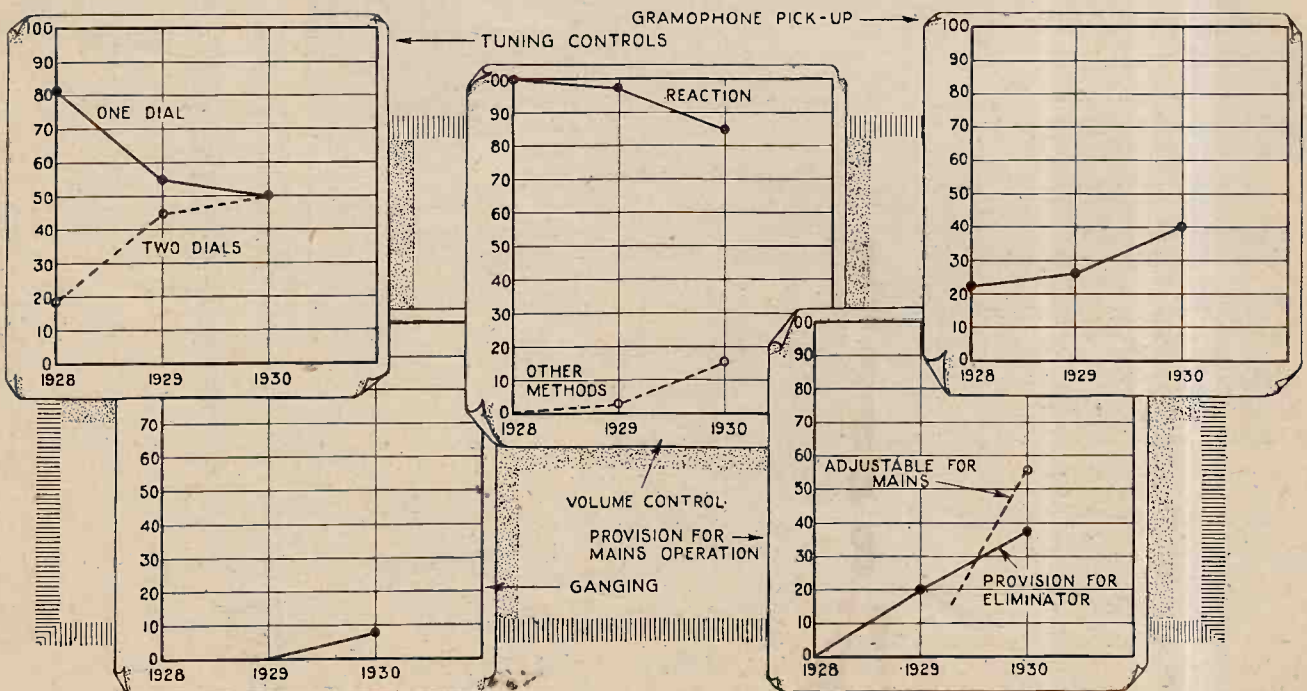

Present-day Portables.—

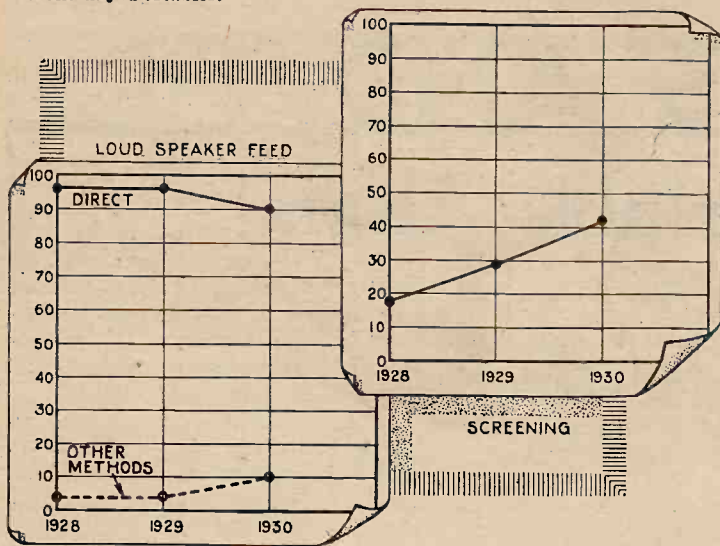

when used in a second stage it is overloaded. Pentode valves available are mostly designed to consume more current from the H.T. battery than can normally be allowed, giving, of course, a greater power output than any portable set triode.

It is now well known that the cost of running a portable is entirely dependent upon the H.T. current consumed. While heavy current consumption, combined with the use of a generous output valve, is the straightforward method of obtaining good quality, it now seems the practice to limit the current taken and to compensate in the rest of the equipment for the reduction in the permissible signal handling properties of the output. Few battery-operated portables consume more than the economical limit of 10 mA., and it is stated elsewhere in this issue that a set of good performance consumes only 8 mA. Several sets of last year required as much as 20 mA., making the cost of H.T. battery maintenance more than four times that of this season's sets.

Nine out of ten sets of last season depended upon the use of reaction as a means of volume control. While swinging the frame is also useful for this purpose, it is now to be noted that there is a growing use of a control following the detector. The reason for this is the more uniform regulation of volume which results as compared with the reaction method, and the fact that tuning which may be critical and interlocked with the adjustment of two dials is not affected.

It is interesting to observe among the specifications that the suitcase type of portables are increasing in number, in the face of a prediction that they would tend to become extinct. Apart from matters of taste, it is probable that manufacturers favour these models as they afford a means of swinging the frame away from

the bulk of the apparatus, and, therefore, give better reception.

Among minor fitments, one notes the general provision for the use of gramophone pick-up, facilities for charging the L.T. accumulator without its removal from the set, the provision of a turn-table now in almost all instances, and a small decline in the use of four-volt accumulators as opposed to two. Sets are no less heavy than formally, and it is obvious that any move in the direction of lightness now means the undesirable cutting down in the sizes of the components. Sets are invariably calibrated in wavelengths and stations, and, on an average, the more successful models will give a daylight reception on the two wave ranges of some six stations in London, and double this number after dark. Foreign instruments and apparatus were not excluded when seeking the information from which this analysis was compiled, but the fact that every set seen was British-made is no longer entirely due to the patent licensing restrictions. The portable is a highly developed product brought into being by an early appreciation of the need for a self-contained set.

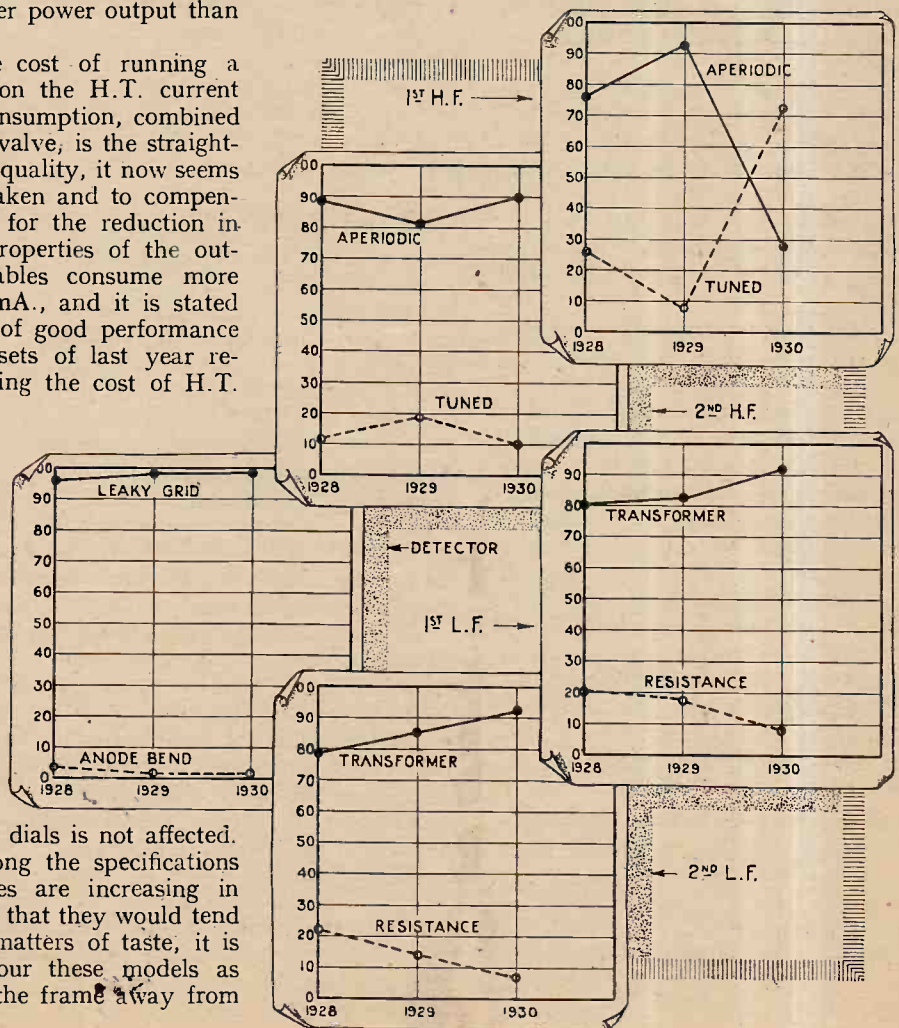



HINTS AND TIPS

for Portable Users

Some Practical Suggestions for Increasing the Efficiency of Self-contained Sets.

SCREENING THE DETECTOR.

In the design and construction of high-efficiency sets, it is usual to take great pains in the screening of the H.F. valves and their associated apparatus—and then to forget the detector.

Puzzling effects generally manifest themselves in the form of instability, which sometimes is traceable to electrostatic pick-up by the connections, or even the electrodes, of this valve, and, where results are unsatisfactory, it is worth while trying the effect of screening it in an earthed metal container.

Incidentally, it should, perhaps, be pointed out that the term "earthed," as applied to a self-contained or portable set, must not of necessity be taken in its literal sense; the majority of portables work without an earth. It is to be understood that the part in question is connected to the H.T.-L.T. interconnection bus-bar, which in every set is the datum line or earth line. One will seldom go far wrong in thus "earthing" any stray pieces of metal, such as loud speaker frames, the metal cases of by-pass condensers, L.F. transformer shrouds, and, of course, screens of every sort.

ELIMINATING THE H.F. AMPLIFIER.

Although there is some risk in attempting to make provisions for cutting out a tuned high-frequency amplifier, it is generally fairly easy to eliminate aperiodic H.F. stages, and it is worth while trying to do so when the receiver is used largely for

reception of a near-by station, for which an unassisted detector would be adequate.

To make the alteration, the existing connection to the first valve grid terminal should be transferred to the detector-grid condenser, after having removed the wire that is connected to that point. A filament switch must, of course, be added for the H.F. valves.

SPARE THE H.T. BATTERY.

The cost of H.T. battery renewals is one of the most serious items in the maintenance of a portable receiver, and where economy must be observed, it is useful to know of any means whereby the drain on the cells may be reduced. Of course, good quality and adequate volume cannot be obtained without the dissipation of a reasonable amount of power in the output valve anode circuit, but where really good reproduction can hardly be expected—as when receiving stations at the extreme limit of range—or when full volume is not required, current consumption can be reduced by applying to the output valve a negative bias rather higher than that normally used. The same results could be brought about by reducing anode pressure, but this course would lead to unequal discharge of the various sections of the battery, and would generally be less convenient.

In any case, one's guiding principle should be to work with as much negative bias as possible, consistent with good quality; it should

be remembered that individual valves vary as to their best operating conditions, and so the manufacturers' suggestions cannot be taken as final in every case.

It is sometimes forgotten that as the H.T. battery voltage drops—as it inevitably must do in the course of use—a slight reduction in negative bias is called for, if quality is to be maintained. Naturally, as H.T. voltage falls, the maximum intensity or undistorted power output that is obtainable will also be reduced.

o o o o

FRAME AERIALS BY RULE OF THUMB.

The following rule, though not infallible, is sufficiently accurate to be useful.

Assuming a frame of fairly normal dimensions and construction, an inductance suitable for covering the medium broadcasting waveband will be afforded if a total length of 75 feet of wire is used; similarly, for the longer waveband, 250 feet will be required.

o o o o

A PILOT LAMP.

The importance of saving anode current has already been urged; it may, perhaps, be permissible to point out, particularly to the forgetful listener, that the cells may be almost completely exhausted if the set is left overnight with its valves "on." This risk of doing this is greatly lessened if a pilot lamp, preferably one showing a red light, is fitted. These lamps are now available with metal filaments taking quite a small current, and they can be installed in existing sets without very much difficulty from the mechanical point of view; as far as electrical connections are concerned, all that is necessary is to run a pair of leads from the lamp holder to the filament terminals of the most convenient valve holder.

Hints and Tips for Portable Users.—

MOUNTING THE FRAME AERIAL.

When long range is particularly desired, it is worth while remembering that, all other things being equal, a frame aerial built in the lid of a portable set container in such a position that it is not in immediate proximity to a considerable mass of metal is likely to be rather more effective as a collector than when its windings surround the majority, if not all, of the apparatus used in the construction of the set.

In any case, it is advisable to make allowance for a certain amount of spacing—at least three-quarters of an inch—between the frame and large masses of metal, such as screening boxes, H.T. batteries and accumulator.

modified "Hartley" detector with throttle-controlled reaction, and a transformer-coupled L.F. magnifier. The point of interest is that the set was constructed to fit into the cubby-hole of a saloon car; in view of the limitations of space, considerable care had to be taken both in choice of components and in layout. The set was intended purely for use with headphones.

One of the car battery cells was used for L.T. supply, connections to it being made with the help of strong spring clips, while H.T. current was derived from a 36-volt dry battery placed in the rear luggage locker and connected by a concealed twin flexible lead running the length of the car.

As an aerial, two parallel lengths

SCREENED LOUD SPEAKER LEADS.

In spite of the most elaborate precautions with regard to the disposal of H.F. currents in the anode circuit of the detector valve, it is not unusual to find that a residue is left in the anode circuit of the output valve. If this is passed back to the frame aerial, instability may result, and so it is a good plan to wire the loud speaker with twin armatured flexible cable having a metallic sheathing, which, incidentally, should be earthed.

In cases where this armatured wire is not readily obtainable from wireless dealers, it is useful to know that it is generally stocked by dealers in motor car accessories.

o o o o

VOLUME CONTROL.

Although a completely unobjectionable input (or predetection) volume control has yet to be devised, it is probably true to say that we come nearer to achievement of the ideal in the portable receiver, without having made any special efforts to do so. If directional effects are fairly well marked, nearly perfect adjustment of intensity can be made by orientation of the frame aerial.

In order that critical adjustment may be made, it is almost essential that the set should be fitted with a turntable, and if it does not already include this device, it may be worth while to add it.

o o o o

SECURING THE BATTERIES.

Methods of securing both H.T. and L.T. batteries in portable receivers are not always beyond reproach, as they are sometimes merely placed in a compartment of approximately the right size, and no particular precautions are taken to prevent them from moving about. If it is likely that the receiver is to receive rough treatment, it may be advisable to improve matters in this respect. As packing material to place between H.T. and L.T. batteries, and also between these batteries and the sides of the container, it is difficult to find a better material than sponge rubber sheet, which is obtainable in various thicknesses. It has the necessary resiliency, is not affected by accumulator acid, and can be washed if necessary.

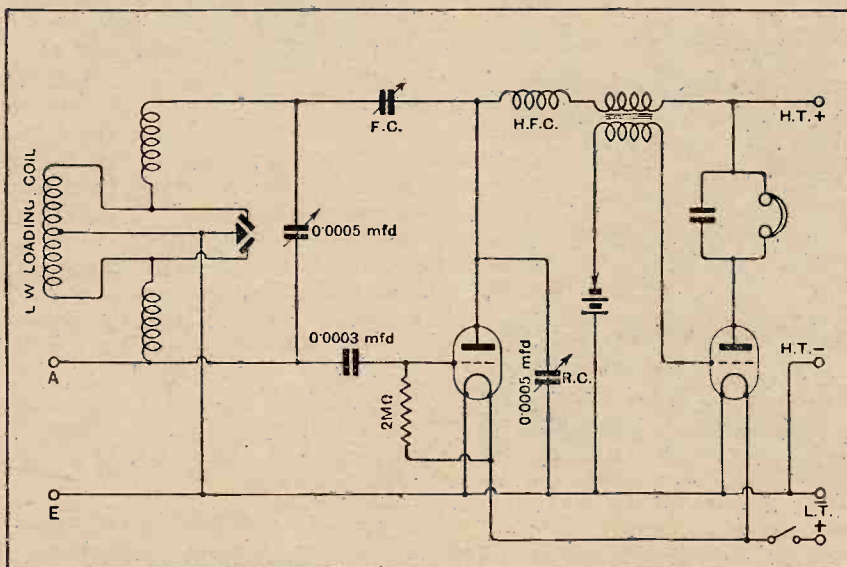

Circuit diagram of a built-in receiver for the car. The reaction feed condenser (F.C.) may be of the semi-variable variety, with a maximum capacity of 0.0001 mfd. or even less.

THE CUBBY-HOLE PORTABLE.

The writer of these notes recently had an opportunity of examining and operating an exceedingly neat and compact two-valve det.-L.F. receiver made by a reader of *The Wireless World* for use in his car. The set seemed so practical in its design, and was so satisfactory in its performance, that it is thought likely that a few details concerning it may be of interest to others.

A theoretical diagram, reproduced on this page, shows that there is nothing abnormal or particularly intriguing with regard to the circuit arrangement, which consists of a

of wire were stretched under the roof and were concealed by the inner covering. A lead-in wire—which, incidentally, was the only visible external connection—was neatly cleated to the near-side front pillar. Of course, an earth—or rather a counterpoise—connection was obtained by making a junction to a convenient point on the metal chassis.

The car body was of the fabric variety, and, judging by results, the framework must have been mainly of wood, as the aerial seemed to be quite an efficient collector, despite its small size.

Buyers Guide to 1930 PORTABLE SETS

Abridged Specifications of Self-contained Sets.

IN the following pages are given the essential details of self-contained receivers on the British market. These specifications are prepared from information supplied by the manufacturers, and no efforts have been spared to ensure that the list shall be as nearly complete as possible.

What Constitutes a Portable?

The guiding principle in choosing sets for inclusion in this list is that they should be truly self-contained, needing no external apparatus whatsoever for their operation. Exceptions exist in the case of mains-driven receivers, which, of course, require a connection to the supply mains, and also with regard to sets made up in two units—generally with a separate battery box. Receivers which are self-contained except for aerial-earth connections have been ruled out, though one or two sets designed for use with an exceptionally short aerial are included.

Except where stated to the contrary, it is to be assumed that

- (a) The set is fed from batteries.
- (b) Waveband switching is included, and that both medium and long broadcast wavebands are covered.
- (c) The price quoted is for the complete receiver, with batteries and royalties.

A word as to definitions; There is no clear dividing line between "portable" and "transportable" sets, but it may be taken that the first-mentioned is generally housed in a container of suitcase type, and is designed for convenience of use out-of-doors or when travelling. The "transportable," on the other hand, is primarily intended merely to be moved from room to room, and so greater attention is usually paid to its appearance.

Self-contained mains-driven sets are gaining ground; they should clearly be placed in the "transportable" category, although a few of them are made in "portable" form.

o o o o o o o o o o

ADEY.

One-valve Model.

Two-dial tuning. Provision for connection of external loud speaker. Dimen-

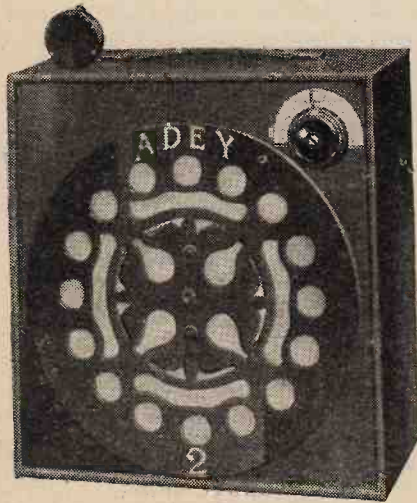

Adey 4-valve Portable.

sions $10\frac{1}{2} \times 10\frac{1}{2} \times 4$ in. Weight 8 lb. Price, including headphones, £3 17s. 5d.

The capacity of the 2-volt low-tension battery is 8 amp. hours.

Two-valve Model.

Detector followed by pentode. Two tuning dials. Provision for connection of external loud speaker and battery charger if required. Dimensions $12 \times 12 \times 7$ in. Weight 16 lb. Price £3 15s.

The capacity of the low-tension battery is 12 amp hours. The total H.T. consumption is about 3 mA. at 81 volts.

Four-valve Model.

Two H.F. stages followed by detector and pentode output. Two-dial tuning. Reaction is included. Dimensions $12 \times 12 \times 7$ in. Weight 17 lb. Price £12 15s.

Adey Radio, Ltd., 99, Mortimer Street, Regent Street, London, W.1.

o o o o

ADVANCE.

Cabinet Portable.

Five valves; two aperiodic H.F. stages, grid detector and two transformer-coupled L.F. amplifiers. Single tuned circuit and reaction on to the frame aerial. Dimensions $16 \times 17 \times 9$ in. Weight 28 lb. Price £18 18s.

A ~~transportable~~ and waterproof canvas

cover are included in the price quoted. Total anode current consumption amounts to 8.5 milliamps.

The Advance Radio Co., Ltd., Carlton House, Lower Regent Street, London, S.W.1.

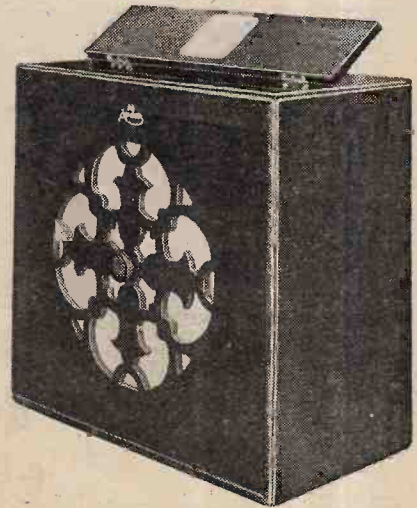

Advance Cabinet Receiver.

Buyers' Guide to 1930 Portable Sets.—

ÆONIC.

Suitcase V.

Two aperiodically coupled H.F. triodes, detector linked to first L.F. valve by resistance coupling; loud speaker



Æonic Portable.

coupled direct to last valve. Volume control by Reinartz reaction. Dimensions 15×12×9in. Weight 27 lb. Price, in real hide, £16 16s.

There is one-dial tuning, and the total anode current is 9 mA.

Screened Grid IV.

One screen-grid H.F. valve coupled by tuned anode to detector. There are two L.F. stages, the last valve being of the P.215 type. Volume control by reaction. L.T. battery 2 volts 35 amp. hours. Dimensions 15×12×9in. Weight 27 lb. Price, in antique hide, £19 19s.



New Amplion Portable.

Two-dial tuning is provided, and metal screening is generously used. The total anode current is 10 mA. at 108 volts.

Æonic Radio, Ltd., 90, Regent Street, London, W.1.

A 19

AMPLION.

Two Screen-grid.

Four valves; two S.G. high-frequency valves, coupled by tuned anode and choke, grid detector, and transformer-coupled pentode valve. Dimensions 16×15½×10in. Weight 37 lb. Price £24 15s.

Suitcase covered in real hide, with oxidised brown metal fittings. The loud speaker is operated by a balanced armature unit, of which the impedance is arranged to suit a pentode. Provision is made for the use of an eliminator.

Graham Amplion, Ltd., 26, Savile Row, Regent Street, London, W.1.

o o o o

APPLEBY.

Suitcase Portable.

Five valves; two aperiodic H.F. stages coupled by iron-cored chokes, grid detector, and two transformer-coupled L.F. magnifiers. Single-dial tuning and reaction. Dimensions, when closed, 15½×12¾×9in. Weight 21 lb. 9 oz. Price £9 19s. 6d.

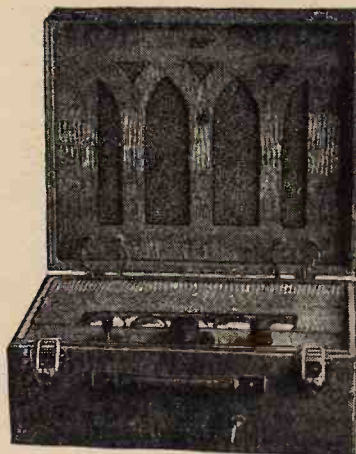

Appleby Portable.

A low-priced suitcase-type portable, fitted with standard British valves and batteries. The case is covered with embossed grained cloth, and is fitted with safety clasps.

E. Hetherington Appleby, 44, Chapel Street, Marylebone, London, N.W.1.

o o o o

ASHLEY.

Upright Transportable.

A four-valve H.F.-det.-2 L.F. receiver with screen-grid H.F. amplifier coupled by the tuned-grid method to a grid detector; there is magnetic reaction between anode and grid circuits of this latter valve. The L.F. amplifier comprises two transformer-coupled stages. Two tuning controls. Dimensions 15¼×7½×7¾in. Weight 33 lb. Price £22.

An alternative model is made for A.C. mains operation. A turntable is fitted, and there are sockets for the connection of an external aerial-earth system. The reaction coil is progressively coupled to the long- or medium-wave grid coils by

rotation of its control in opposite directions from the zero point.

Ashley Wireless Telephone Co. (1925), Ltd., Finch Place, Falkland Street, London Road, Liverpool.

o o o o

AUTOMOBILE ACCESSORIES.

P.D. Melody Portable V.

Two H.F. valves, aperiodically coupled and separately anode fed. Leaky grid detector followed by two transformer-coupled L.F. stages. Volume control by

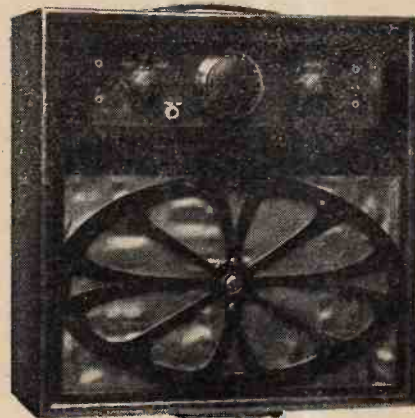

P.D. Melody V.

reaction. One-dial tuning. Loud speaker fed direct from last valve. Dimensions 17×17×8in. Weight 26 lb. Price £16 16s.; de luxe model £18 18s.

There is provision for a gramophone pick-up and the receiver is adaptable for all-mains operation. Terminals are provided for external loud speaker connection. The total anode current is 7 mA. at 102 volts.

Automobile Accessories (Bristol), Ltd., Sion Road, Bedminster, Bristol.

o o o o

BURNDIPT.

Screened Portable, Type No. 1840.

An H.F.-det.-2 L.F. combination with tuned anode and transformer coupling



Burndept Suitcase Receiver.

Buyers' Guide to 1930 Portable Sets.— for the H.F. and L.F. stages respectively. Two tuning controls with reaction. Dimensions $8\frac{1}{2} \times 14\frac{3}{4} \times 14\frac{3}{4}$ in. Weight 30 lb. Price £19 19s.

Suitcase type of receiver, covered in dark brown hide with large crocodile grain finish. The cone loud speaker is driven by a balanced armature unit.

Super-screened Portable, Type No. 1800.

Specification similar to that of receiver type No. 1840, but fitted in a polished hide case, medium brown colour, with small crocodile grain. The interior of the receiver is finished in polished walnut. Price £23 10s. An otherwise similar receiver (type No. 1801) has a polished mahogany interior.

Burndep Wireless (1928), Ltd., 283, Regent Street, London, W.1.

o o o o

BURTON.

Portable.

One S.G. high-frequency amplifier, coupled by the tuned anode method to a grid detector; two transformer-coupled L.F. magnifiers. Two tuning controls with reaction. Dimensions $17\frac{1}{2} \times 15\frac{1}{2} \times 8$ in. Price £18 18s.

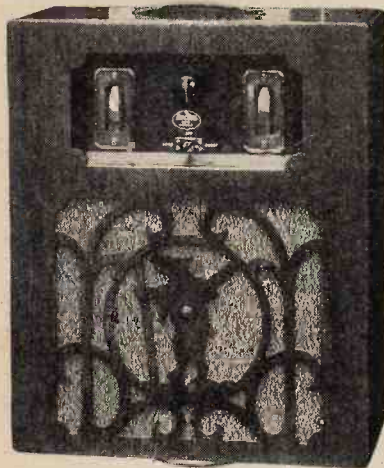

Burton Empire Receiver.

An upright transportable type of set with the receiver proper built as a chassis unit. Differential reaction control is fitted, and the anode circuits are extensively decoupled. The tuned circuits are matched so that the condenser dial readings may coincide as far as possible.

C. F. and H. Burton, Progress Works, Bernard Street, Walsall.

o o o o

CASTAPHONE.

Dual-wave S.4.

One screen-grid H.F. valve choke-coupled to leaky grid detector. Two L.F. stages, transformer- and resistance-coupled respectively. Loud speaker fed direct from last valve. Dimensions $17 \times 17 \times 8$ in. Weight 26 lb. Price £18 18s.

Provision is made for the use of an ex-

ternal eliminator. There is one-dial tuning. The total anode current is 6 mA. at 103 volts.

Gordon Castagnoli, Culver Street, Colchester.



Castaphone Transportable.

o o o o

CHAKOPHONE.

Eagle Screened Four.

Two H.F. stages. The first contains a screen-grid valve, parallel tuned grid-coupled to an aperiodic triode, followed by an anode bend detector. There is one L.F. stage. Generous screening in the H.F. amplifier is provided, and the volume control is by means of swinging coil reaction. Dimensions $17 \times 9 \times 13$ in. Weight 28 lb. Price, in rexine, £17 17s.

The receiver is adaptable for H.T. feed from D.C. mains. There are two tuning controls. The total anode current is 8 mA. at 99 volts.

Eagle "All-in-Three."

A detector - two - L.F. combination. Volume control by means of capacity-controlled reaction. Loud speaker fed direct from last valve. Dimensions $14 \times 14 \times 7$ in. Weight 28 lb. Price £11.

The total anode current is 6 mA. at 90 volts and the capacity of the two-volt L.T. battery is 45 amp. hours.

Eagle "All-in-Two."

A two-valve set consisting of a leaky grid detector, transformer-coupled to a pentode. Volume control by reaction. Loud speaker fed direct from last valve. Dimensions $14 \times 14 \times 7$ in. Weight 28 lb.

The total anode current is 6 mA. at 90 volts, and the two-volt L.T. battery has a capacity of 45 amp. hours. There is provision for externally connecting a H.T. eliminator for D.C. mains.

"Warwick" Portable Five.

Two aperiodically coupled H.F. stages, followed by anode bend detection. There are two transformer-coupled L.F. valves. One-dial tuning and volume control by reaction. Dimensions $17 \times 13 \times 7$ in. Weight 34 lb. Price £16 16s.

Provision is made for a gramophone pick-up. The total anode current is

10 mA. at 108 volts, and the two-volt L.T. battery has a capacity of 48 amp. hours.

Warwick "Junior Five."

Two choke-coupled H.F. stages, followed by an anode bend detector, which, in turn, is linked to two L.F. transformer stages. One-dial tuning. Volume control by capacity-controlled reaction. Dimensions $17 \times 9 \times 12$ in. Weight 26 lb. Price, in polished walnut, £14 14s.

There is provision for connecting a H.T. eliminator for D.C. mains. The total anode current is 8 mA. at 90 volts. The capacity of the two-volt L.T. battery is 24 amp. hours.

Warwick "Junior Four."

Two choke-coupled H.F. valves, anode bend detector, followed by one transformer L.F. stage (pentode). Volume control by reaction. Loud speaker fed direct from last valve. Dimensions $17 \times 9 \times 12$ in. Weight 20 lb. Price, in polished walnut, £13 13s.

The H.T. battery volts are 66, and the capacity of the two-volt L.T., accumulator is 24 amp. hours.

Eagle Engineering Co., Ltd., Warwick.



Chakophone Eagle Screened Four.

o o o o

CLASSIC RADIO.

"Ariel" Five-valve Model.

Two choke-coupled H.F. valves. Leaky grid detector, followed by two transformer-coupled L.F. stages. One-dial tuning and a control of volume by reaction. Dimensions $15\frac{1}{2} \times 12\frac{1}{2} \times 8\frac{1}{2}$ in. Weight 25 lb. Price £14 14s.

The total anode current passed by the set is 6 mA. at 100 volts.

"Ariel" Pigmy.

Four valves; tuned-grid S.G. stage, followed by leaky grid detector, which, in turn, is linked to two transformer-coupled L.F. valves. Two-dial tuning and a control of reaction. Loud speaker fed directly from the last valve. Dimen-

Buyers' Guide to 1930 Portable Sets.—
sions $12\frac{1}{2} \times 12\frac{1}{2} \times 8\frac{1}{4}$ in. Weight 24½ lb.
Price, in blue fabrikoid, £18 18s.

The H.F. amplifier is generously
screened. The total anode current is
7 mA. at 99 volts, while the capacity of
the two-volt L.T. battery is 20 amp.
hours.



Classic Portable.

Suitcase Model.

Four valves; tuned anode H.F. stage,
using S.G. valve. Leaky grid detector,
followed by two transformer L.F. stages.
Two tuning controls and a capacity
control of reaction. Dimensions $17 \times 14 \times 9\frac{1}{2}$ in.
Weight 31 lb. Price, in antique hide,
£21.

The total anode current is about 11 mA.
at 120 volts.

Classic Radio and Gramophone Co.,
Ltd., 25, Eccleston Street, London,
S.W.1.

o o o o

COLUMBIA.

Model 303A.

Two H.F. stages (one tuned, one aperi-

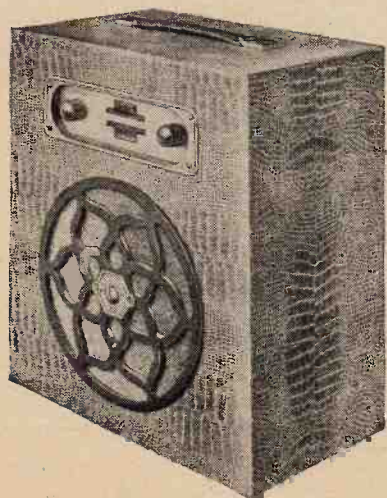

Columbia 2-H.F. Receiver.

odic), grid detector, and two transformer-
coupled L.F. magnifiers. Two tuning
controls with reaction. Dimensions
 $16\frac{1}{2} \times 13\frac{3}{4} \times 8\frac{3}{4}$ in. Weight 28 lb. Price
£17 17s.

A transportable receiver in an oak case,
mounted on a turntable. Provision is
made for using an eliminator; the accu-
mulator cell has a capacity of 30 ampere
hours.

Type 303B.

Specification as for Model 303A, but
mounted in case covered with blue croco-
dile cloth. The external metal parts are
silver oxidised. Price £19 19s.

Model 303C.

Five valves; two aperiodic H.F. stages,
grid detector, and two transformer-
coupled L.F. magnifiers: single tuning
control with reaction. Dimensions
 $16\frac{1}{2} \times 13\frac{3}{4} \times 8\frac{3}{4}$ in. Weight 28 lb. Price
£17 17s.

In upright oak cabinet fitted with turn-
table. This set is similar to Model 303A,
although it has but a single tuning con-
trol.

Model 303D.

Similar to Model 303C, but mounted in
a case covered with blue crocodile leather
cloth, and metal parts silver oxidised.
Price £19 19s.

Columbia Graphophone Company, Ltd.,
92, Clerkenwell Road, London, E.C.1.

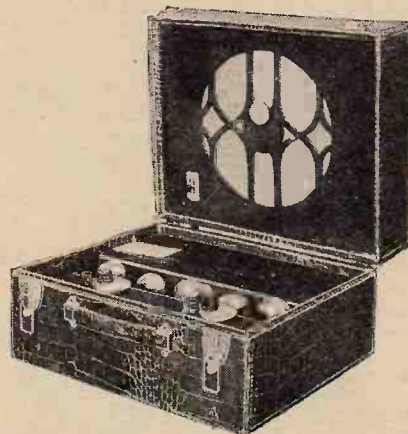

Silvert Suitcase Model.

o o o o

CONTAL RADIO.

"The Silvert" Upright Model.

Two H.F. valves coupled by leaky grid
detector to two L.F. stages. Volume
control by reaction. Dimensions
 $16 \times 12 \times 9$ in. Weight 28 lb. Price
£12 12s.

There is provision for connecting ex-
ternal loud speaker, and the set is adapt-
able for all-mains operation. The total
anode current is 12 mA. at 108 volts.

"The Silvert" Suitcase Model.

Circuit details the same as those of the
upright model. Dimensions $15\frac{1}{2} \times 13\frac{1}{2} \times 9\frac{1}{2}$ in.
Weight 28 lb. Price £12 12s.

Contal Radio, Ltd., 8, Spital Square,
Bishopsgate, London, E.C.1.

DAVEX.

Transportable V.

Two aperiodic H.F. stages, grid detec-
tor, and two transformer-coupled L.F.
magnifiers. Single tuning control with
reaction. Dimensions $16\frac{1}{2} \times 17 \times 7\frac{1}{2}$ in. Price
£15 15s.

In solid oak upright cabinet, fitted with
Ultra Air Chrome or Mullard loud
speaker.



Davex Suitcase Receiver.

Portable Screen Grid IV.

One S.G. high-frequency valve, with
aperiodic coupling to a leaky-grid detec-
tor, and two transformer-coupled L.F.
magnifiers. One tuning control with re-
action. Dimensions $16 \times 9\frac{1}{2} \times 13$ in. Price
£17 10s.

Available in blue, brown, or maroon
case, fitted with Ultra Air Chrome loud
speaker.

Popular Suitcase V.

Two aperiodic H.F. amplifiers, with
grid detector, followed by resistance- and
transformer-coupled L.F. amplifier. Single
tuning control with reaction. Dimensions
 $16 \times 9\frac{1}{2} \times 13$ in. Price £13 5s.

In brown crocodile suitcase.

St. Mary's Motor Company, St. Mary's
Road, Market Harborough.



Decca Transportable.

Buyers' Guide to 1930 Portable Sets.—

DECCA.

Transportable Model 21.

Two aperiodic H.F. stages and grid detector, followed by transformer- and resistance-coupled L.F. magnifiers (in that order). Single tuning control with reaction. Dimensions $17 \times 19 \times 8\frac{1}{4}$ in. Weight 36 lb. Price £22 1s.

Mounted in upright oak cabinet, fitted with figured walnut doors for the control panel. A turntable is fitted, and the accumulator is of the non-spillable type with jelly electrolyte.

Transportable Model 16.

Five valves; two aperiodic H.F. stages, grid detector; and two L.F. amplifiers with transformer and resistance coupling, in that order. Single-tuning control with reaction. Dimensions $16\frac{1}{2} \times 15\frac{3}{4} \times 8\frac{3}{4}$ in. Weight 34 lb. Price £16 16s.

In oak cabinet with fretted front. A turntable is fitted.

The Decca Gramophone Co., Ltd., 1 and 3, Brixton Road, London, S.W.9.



Defex Straight Five.

o o o o

DETEX.

Straight Five.

Two aperiodic H.F. stages, grid detector, and two transformer-coupled L.F. magnifiers. One tuning control with reaction. Dimensions $14 \times 14 \times 8$ in. Weight 23 lb. Price £8 8s.

A low-priced suitcase portable of conventional design, in a case covered with fabric—blue, red, green morocco or imitation lizard, to choice. Fitted with 100-volt H.T. battery and 20-ampere-hour accumulator.

Detex Distributors, Ltd., 66, Victoria Street, London, S.W.1.

o o o o

DORIAN.

Screened Grid Four.

S.G. high-frequency stage, grid detector, and two L.F. stages, with leaky-grid detection. Two tuning controls with re-

action. Dimensions $9\frac{1}{2} \times 15 \times 13\frac{1}{2}$ in. Weight 33 lb. Price £19 19s.



Dorian S.G. Four.

A suitcase receiver with Celestion loud speaker and frame aerial mounted in the lid. A turntable is fitted to the base of the case.

The Dorian Wireless Co., Ltd., 18, Shepherd's Bush Green, London, W.12.

o o o o

DUBILIER.

"Westminster" Portable Radio Gramophone.

Four-valve set; the first screen-grid stage is tuned grid coupled to a second S.G. valve, which is aperiodically linked to a leaky grid detector. There is one pentode L.F. stage, which is directly coupled to the loud speaker. Two-dial tuning and reaction control. Dimensions $20 \times 18 \times 9\frac{1}{2}$ in. Weight 58 lb. Price, including turntable, £30 9s.

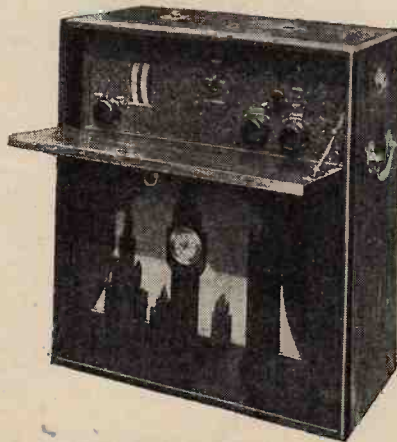

Dubilier Westminster Radio-gramophone.

There is provision for gramophone pick-up. Special attention has been paid to screening the H.F. stages. The total anode current is 7 mA. at 120 volts.

Dubilier Condenser Co. (1925), Ltd., Ducon Works, Victoria Road, North Acton, London, W.3.

DUNHAM.

Portable Five.

Two aperiodic H.F. stages, grid detector, and resistance- and transformer-coupled L.F. magnifiers (in that order); one tuning control with reaction. Dimensions $9\frac{1}{2} \times 15\frac{1}{2} \times 12\frac{1}{2}$ in. Weight 25 lb. Price £17 17s.

Suitcase receiver, with provision for using external aerial and earth. Container covered in leather or Rexine lizard skin.

Screened Grid Portable.

S.G. high-frequency amplifier, grid detector, and two transformer-coupled L.F. stages. Two tuning controls with reaction. Dimensions $9\frac{1}{2} \times 15\frac{1}{2} \times 12\frac{1}{2}$ in. Weight 23 lb. Price £21.

Suitcase receiver, covered in Rexine lizard skin or leather. Tuning controls are so mounted that both circuits can be tuned simultaneously with one hand, the other hand being left free to manipulate the reaction knob. One condenser scale is calibrated on both medium and long wavebands.

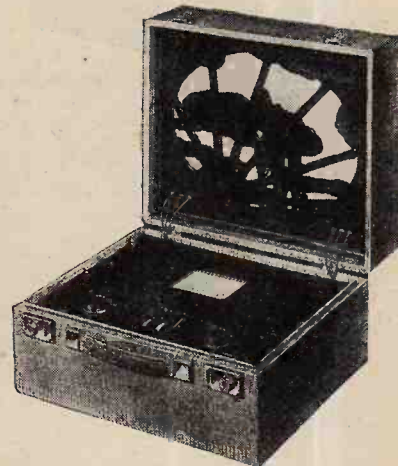

Dunham Screen-grid Receiver.

Transportable.

Two aperiodic H.F. stages, grid detector, and resistance- and transformer-coupled L.F. magnifiers. Single tuning control with reaction. Dimensions $18 \times 15\frac{1}{2} \times 7$ in. Weight 25 lb. Price £17 17s.

Upright cabinet receiver in polished oak, or Rexine lizard skin. A turntable is fitted.

Dunhams, Ltd., Bellerophon Works, New Wharf Road, London, N.1.

o o o o

ECONOMIC.

Metropolis.

A special superheterodyne circuit, in which screen-grid valves are used as first detector and for intermediate amplification, with a triode second detector and a pentode in the output position, together with a triode as separate oscillator. Two tuning controls. Dimensions $13 \times 12 \times 8$ in. Weight 22½ lb. Price £31 10s.

An H.T. voltmeter and a turntable are

Buyers' Guide to 1930 Portable Sets.— fitted. Volume is controlled by adjustment of voltage feed to the screens of the S.G. valves.
Faerie.

Two aperiodic H.F. stages, grid detector, and two transformer-coupled L.F. magnifiers. Single tuning control with reaction. Dimensions 13 x 12 x 8 in. Weight 22 lb. Price £14 14s.



Economic Metropolis Receiver.

A compact receiver fitted with turntable, 100-volt H.T. battery, and a 25 ampere-hour accumulator cell. A patented screened reaction system is included.

Economic Electric, Ltd., 10, Fitzroy Square, London, W.1.

o o o o

EDDYSTONE.

Scientific Portable Three.

One S.G. high-frequency valve, grid detector and pentode output valve. Two



Eddystone Three-valve Receiver.

A 23

tuning controls with reaction. Dimensions 15½ x 15½ x 10 in. Weight 34 lb. Price £26 15s.

A suitcase type of portable receiver. The fittings include a Celestion loud speaker, Exide L.T. accumulator and a triple-capacity H.T. battery.

Stratton and Co., Ltd., Balmoral Works, Bromsgrove Street, Birmingham.

o o o o

EDISON BELL.

"Maison" Screened Grid Three.

One H.F. stage, with S.G. tuned-anode coupling. Leaky-grid detector followed by pentode L.F. stage. The loud speaker is directly coupled to the last valve. Two-dial tuning and reaction control. An external loud speaker can be readily connected if required. Dimensions 18 x 15 x 7½ in. Weight 21 lb. Price in oak £14.

There is provision for connecting a gramophone pick-up, and the receiver is adaptable for all-mains operation. The total anode current is about 13 mA. at 99 volts, the two-volt L.T. battery has a capacity of 35 amp. hours.



Edison Bell Five-valve Receiver.

Picnic Portable.

Five valves; the two H.F. triodes are aperiodically coupled by 60,000-microhenry chokes. The leaky-grid detector is followed respectively by resistance- and transformer-coupled L.F. stages. Dimensions 13½ x 13½ x 10 in. Weight 26 lb. Price £16 16s., de luxe model £17 17s.

The total anode consumption of the receiver is about 8½ mA. at 99 volts, and the two-volt L.T. battery has a capacity of 35 amp. hours.

Edison Bell, Ltd., 169, Regent Street, London, W.1.

o o o o

EDISWAN.

A.C. All-Mains Transportable.

Four valves; one stage S.G. H.F. with tuned anode coupling, leaky-grid detector followed by two L.F. stages. Price £31 10s.

There is provision for connecting a gramophone pick-up, also terminals for an external loud speaker. The total anode current is about 16 mA. The loud

speaker consists of a balanced armature unit with corrugated cone:

The Edison Swan Electric Co., Ltd., 1a, Newman Street, London, W.1.

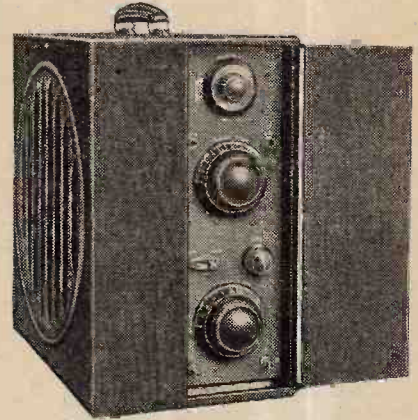

Ediswan Mains-driven Transportable.

o o o o

EFESCAPHONE.

"Ascot" Screened Four.

Four valves; one S.G. tuned H.F. amplifier followed by leaky-grid detection, two L.F. stages, the last coupled to the loud speaker by a transformer. Volume control by reaction. Provision for connection of external loud speaker. Dimensions 16½ x 15½ x 10 in. Weight 36 lb. Price in blue leatherette £17 17s., in solid hide £19 19s.

The total anode current is 9 mA. at 100 volts.



Efescaphone Ascot S.G. Receiver.

Efescaphone Regional Three.

Regenerative leaky-grid detector followed by two L.F. stages. One-dial tuning and a control of reaction. Dimensions 15½ x 13½ x 9½ in. Weight 36 lb. Price £12 15s.

The loud speaker is transformer-coupled and the total anode current is 4 mA. at 100 volts.

Falk, Stadelmann and Co., Ltd., Efesca Electrical Works, 83-93, Farringdon Road, London, E.C.1.

**Buyers' Guide to 1930 Portable Sets.—
G.E.C.**

Three-valve All-Electric, B.C.3038.

Point-8 type S.G. valve, with tuned anode coupling to D.8 detector, which in turn is connected via a Hiflux transformer to a P.T.625 pentode. Leaky-grid

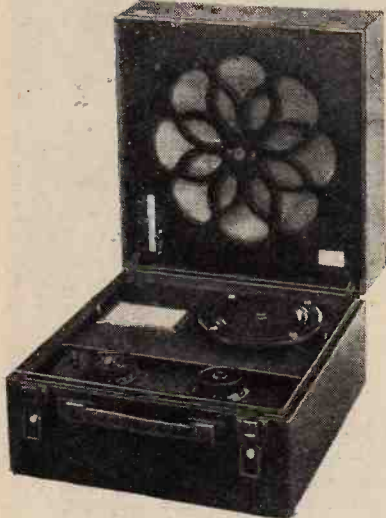

G.E.C. Screen-grid Four.

detection. Loud speaker filter-fed from last valve. Dimensions $11\frac{1}{4} \times 17 \times 17\frac{1}{2}$ in. Weight, with all-mains equipment, 50 lb. Price, including all-mains equipment, £28.

There is two-dial tuning and a control of reaction. Metal screening is generously used in the H.F. amplifier.

Screen-grid Four.

One H.F. stage with tuned-anode coupling followed by leaky-grid detection and two transformer-coupled L.F. stages. Two-dial tuning and a control of reaction. Dimensions $10\frac{1}{2} \times 15\frac{1}{2} \times 15\frac{3}{4}$ in. Weight 35 lb. Price £24 3s.

A turntable is fitted as standard. The total anode current is about 13 mA. at 100 volts, and the two-volt accumulator has a capacity of 20 amp. hours.

General Electric Co., Ltd., Magnet House, Kingsway, London, W.C.2

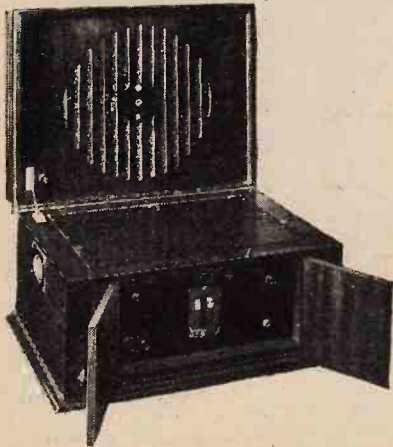

Gambrell Mains-driven Receiver.

GAMBRELL.

All-Electric Transportable.

S.G. high-frequency amplifier, grid detector and pentode output valve. Two tuning controls and reaction. Dimensions $21 \times 16 \times 14$ in. Weight 39 lb. Prices: for A.C. £32, for D.C. £29.

A self-contained mains-driven receiver of the portable type, with loud speaker in a folding lid and controls concealed by folding doors in the front section of the base.

Gambrell Radio, Ltd., 6, Buckingham Street, Strand, London, W.C.2.

o o o o

GODWINEX.

Model H.

Four valves; one S.G. high-frequency stage, coupled by tuned grid circuit to a grid detector, which is followed by two transformer-coupled L.F. magnifiers. Two tuning controls with reaction. Dimensions $15 \times 15 \times 10\frac{1}{2}$ in. Weight 30 lb. Price £22

Volume control is effected by applying positive or negative magnetic reaction. The receiver can be fed from the mains with the help of a specially made H.T. unit and trickle charger.

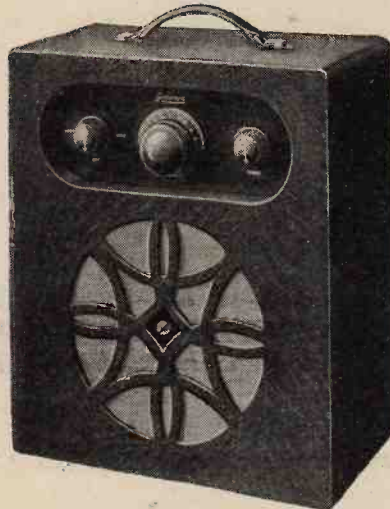

Godwinex Five-valve Model.

Model D.

Two aperiodic H.F. stages, with a grid detector, followed by resistance- and transformer-coupled L.F. magnifiers. One tuning control, with reaction. Dimensions $17 \times 14 \times 8$ in. Weight 25 lb. Price £16 16s.

An upright transportable receiver in oak cabinet, fitted with turntable. A special H.T. eliminator is made to suit the receiver.

J. Dyson and Co. (Works), Ltd., St. Stephen's House, 2, Coleman Street, London, E.C.2.

o o o o

GOODWIN RADIO.

Transportable Five.

Two aperiodic choke-coupled triodes. Leaky-grid detector followed by two transformer-coupled L.F. stages. One-dial tuning and a control of reaction. The loud speaker is fed direct from the last

valve. Dimensions $14 \times 8 \times 16\frac{1}{2}$ in. Weight 27 lb. Price £15 15s.

There is provision for a gramophone pick-up and the receiver is so arranged that it can be used with a combined H.T.



Goodwin Transportable Five

and trickle charger. A turntable and fuse are fitted as standard.

A suitcase model, weighing 21 lb., containing the same type of receiver, is also marketed at £15 15s.

Goodwin Radio, Ltd., 395, St. John Street, London, E.C.1.

o o o o

GOULD HARPER AND CO.

Transportable.

Two aperiodic H.F. stages, grid detector and two transformer-coupled L.F. magnifiers. Single tuning control with reaction. Dimensions $17 \times 17 \times 8\frac{1}{2}$ in. Weight 26 lb. Price £16 16s.

In upright mahogany cabinet, fitted with Six-Sixty loud speaker, and adaptable for all-mains operation. Space is provided in the cabinet for carrying a spare accumulator.

Gould Harper and Co., Tatnam Road, Poole, Dorset.

o o o o

HADDON POUPARD.

P.R.7 Transportable.

Five valves; two choke-coupled aperiodic H.F. valves followed by leaky-grid de-

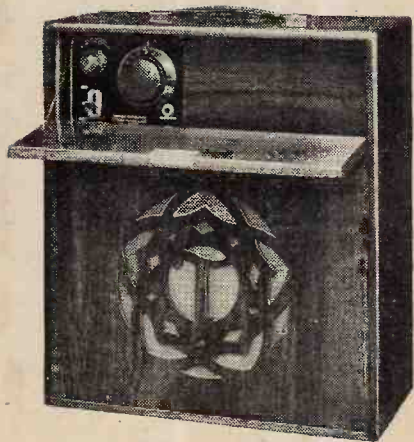

Haddon Poupard Transportable.

Buyers' Guide to 1930 Portable Sets,—
tector. Two transformer-coupled L.F. stages. Loud speaker fed direct from last valve. One-dial tuning and a capacity-control of reaction. Dimensions $16\frac{1}{2} \times 8\frac{1}{2} \times 18\frac{1}{2}$ in. Weight 36 lb. Price £22 1s.

There is provision for connecting a gramophone pick-up, and the receiver is adaptable for all-mains operation. The total anode current is 14 mA. at 120 volts, and the capacity of the two-volt L.T. battery 30 amp. hours. The low-tension accumulator can be charged without removal from the set.

*C. Haddon Poupard and Co., Ltd.,
Thermon Works, Ilford.*

o o o o

HART COLLINS.

Passport S.G. Four-Valve.

One S.G. H.F. stage transformer-coupled to leaky-grid detector. Two L.F. stages. Two-dial tuning and a control of reaction. There is provision for connecting an external loud speaker. Dimensions $14\frac{1}{2} \times 12 \times 8\frac{1}{2}$ in. Weight 25 lb. Price, standard model, £21 5s.; de luxe model, £23 10s.



Hart Collins S.G. Four-valve Receiver.

The anode current, which totals 7 mA., is provided by a 99-volt H.T. battery. The capacity of the L.T. accumulator is 25 amp. hours.

Hart Collins, Ltd., 38a, Bessborough Street, London, S.W.1.

o o o o

HOLT AND CROMPTON.

"Lion Cub."

Five valves; two aperiodic H.F. stages, using triodes. Leaky-grid detector followed by two transformer-coupled L.F. valves. One-dial tuning and a control of reaction. Adaptable for use with eliminator and trickle charger. Dimensions $16\frac{1}{2} \times 12 \times 7\frac{1}{2}$ in. Weight 26 lb. Price £17 17s.

A turntable is fitted as standard. The total anode current of 9 mA. is supplied by a 100-volt H.T. battery. The capacity of the L.T. accumulator is 25 amp. hours.

A 25



Holt and Crompton Lion Transportable.

"Lion Monarch."

Five valves; coupled as in the "Lion Cub." One-dial tuning and a volume control. Dimensions $16\frac{1}{2} \times 12\frac{1}{2} \times 8\frac{1}{2}$ in. Weight 29 lb. Price £19 19s.

Volume control consists of a high-resistance potentiometer shunted across the first L.F. transformer. The total anode current is 10 mA. at 120 volts.

Holt and Crompton, 196, Shaftesbury Avenue, London, W.C.2.

o o o o

I.D.S.

All-Mains Five, Type X2.

Five indirectly heated valves. The last valve is transformer-coupled to the loud speaker. Provision for connection of external loud speaker. Dimensions 16×8 in. Weight 15 lb. Price, for A.C. mains, £17 17s.; for D.C. mains, £16 16s.

Ideas Development Syndicate, Ltd., 4, Golden Square, Piccadilly Circus, London, W.1.

o o o o

IGRANIC.

Universal Portable.

Five valves; two H.F. stages with screen-grid valves, the first being coupled by the tuned anode method (neutralised) and the second by a resistance. A leaky-grid detector is followed by resistance- and transformer-coupled L.F. magnifiers. Tuning of the two tuned circuits is controlled by a single knob; reaction is fitted. Dimensions: Receiver, $16 \times 16\frac{1}{2} \times 8\frac{1}{2}$ in.; battery box, $13\frac{3}{8} \times 10\frac{3}{8} \times 5\frac{1}{4}$ in. Weight, complete, of both containers together, 50 lb. Price £33 2s. 6d.

A receiver of the suitcase type, with a separate container of small dimensions for accommodating the batteries. Volume is controlled by dimming the H.F. valve filaments.

Neutrosomic Seven.

A superheterodyne receiver, in which both detectors function on the anode-bend principle. There is potentiometer control

of input to the I.F. amplifier, and three tuning controls. Dimensions: Receiver, $16\frac{3}{8} \times 12\frac{1}{4} \times 10\frac{3}{8}$ in.; battery box, $14\frac{3}{8} \times 13\frac{1}{8} \times 13\frac{3}{8}$ in. Weight (two units), 70 lb. Price £69.

The receiver itself is housed in one container, while another case accommodates the loud speaker, frame aerial, and batteries; connection between the two is made by a multiple cable and plug. When in operation the loud speaker is removed from its container.

Igranic Electric Co., Ltd., 149, Queen Victoria Street, London, E.C.4.



Igranic Universal 2-H.F. Portable.

o o o o

KOLSTER-BRANDES.

K.-B. Portable.

Four valves; screen-grid H.F. valve transformer-coupled, leaky-grid detector followed by two transformer-coupled L.F. stages. Two-dial tuning and a control of volume by reaction and orientation of receiver. Loud speaker coupled directly to



Kolster-Brandes K.-B. Portable.

Buyers' Guide to 1930 Portable Sets.—
last valve. Dimensions $17 \times 16\frac{1}{2} \times 9\frac{1}{2}$ in.
Weight 36 lb. Price, in oak case
(K.-B.103) and in leather case (K.-B.156)
£18 18s.

*Kolster-Brandes, Ltd., 68-69, Shoe
Lane, London, E.C.4.*

o o o o

LAMPLUGH.

Suitcase Five.

Two aperiodic H.F. triodes, coupled to
a leaky-grid detector which in turn is
connected to two transformer L.F. stages.
One-dial tuning and reaction. Loud
speaker fed direct from last valve.
Weight 30 lb. Price, in imitation hide,
£16.

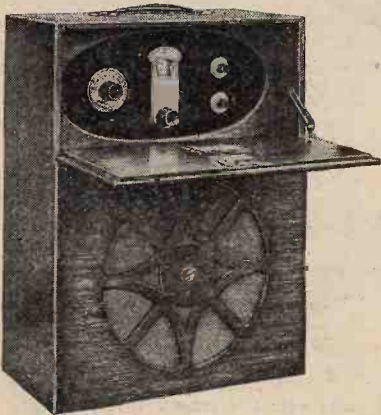

Lamplugh Transportable—five.

Transportable.

Same circuit as that of the Suitcase
Five. Weight 34 lb. Price £15 15s.

*S. A. Lamplugh, Ltd., King's Road,
Tyseley, Birmingham.*

o o o o

LANGHAM.

Popular Five.

Two aperiodic H.F. stages. Re-
generative leaky-grid detector followed by
two L.F. transformer stages. Dimensions
 $14\frac{3}{4} \times 14\frac{3}{4} \times 9\frac{1}{2}$ in. Weight 30 lb. Price, in
blue leather cloth, £18 18s.; in brown
leather cloth, £16 16s.

The total anode current is 7 mA. at 99
volts H.T. The capacity of the L.T. bat-
tery is 20 amp. hours. There is provision
for connecting a gramophone pick-up.

Screened-Grid Four.

One S.G. H.F. stage aperiodically
coupled to a leaky-grid detector. Two
L.F. stages, transformer- and resistance-
coupled in that order. One-dial tuning
and a capacity control of reaction. Dimen-
sions $15\frac{3}{4} \times 15\frac{3}{4} \times 9\frac{1}{2}$ in. Weight 30 lb.
Price £18 18s.

The total H.T. consumption is 11 mA.
at 99 volts. The ampere-hour capacity of
the L.T. accumulator is 20.

*Langham Radio, Ltd., 14-29, Windsor
Street, Islington, London, N.1.*

o o o o

LINDLEY.

Suitcase Portable.

Five valves; two H.F. valves linked to
a leaky-grid detector in turn followed by



Lindley Transportable Receiver.

two L.F. stages, resistance- and trans-
former-coupled respectively. Volume con-
trol by reaction. Provision for connec-
tion of external loud speaker. Dimensions
 $14 \times 13 \times 9$ in. Weight 25 lb. Price
£19 19s.

The capacity of the L.T. accumulator
is 20 amp. hours and the total anode cur-
rent of 8 mA. is provided by a 105-volt
H.T. battery.

Transportable.

Same circuit as that of Suitcase Port-
able. Dimensions $18 \times 15\frac{1}{2} \times 8$ in. Weight
30 lb. Price £19 19s.

*Lindley and Co., 14, Great Queen
Street, London, W.C.2.*

o o o o

LISSEN.

Two-valve A.C. Mains Transportable.

Grid detector, transformer-coupled to
pentode output valve. Single tuning con-
trol with reaction. Price £11 11s.

A self-contained set, driven entirely
from A.C. mains, except for a grid-bias
battery. Medium and long wavebands are
covered, and provision is made for con-
necting a gramophone pick-up. Construc-
tion is on the metal chassis principle.



Lissen Transportable Receiver.

Suitcase Portable.

Five valves; two aperiodic H.F. stages,
grid detector, and two transformer-

coupled L.F. magnifiers. One tuning con-
trol, with reaction. Price £19 19s.

A suitcase type of receiver. Anode cur-
rent consumption amounts to approxi-
mately 8 milliamperes.

Popular Portable.

Five valves; two aperiodic H.F. stages,
grid detector, and two transformer-
coupled L.F. magnifiers. Single tuning
control with reaction. Price £16 16s.

In leatherette-covered suitcase.

Four-Valve Transportable.

Two screen-grid H.F. valves with, re-
spectively, aperiodic and tuned couplings.
The grid detector is transformer-coupled
to a pentode. Two tuning controls with
reaction. Price £34 13s.

An upright transportable receiver in
walnut case.

*Lissen, Ltd., Lissen Works, Worpole
Road, Isleworth, Middlesex.*

o o o o

LOTUS.

Four-Valve S.G. Portable.

Two H.F. stages (one untuned, one
tuned) and grid detector, transformer-
coupled to pentode; two tuning controls
with reaction. Dimensions $15\frac{1}{4} \times 13\frac{1}{2} \times$
 $12\frac{1}{2}$ in. Weight 35 lb. Price £19 19s.

Mounted in a hide case, with metal re-
inforcement.



Lotus All-electric Transportable.

All-Electric Transportable.

Screen grid high-frequency valve
coupled by a tuned transformer to a grid
detector. The pentode output valve is also
transformer-coupled. Two tuning con-
trols and reaction. Dimensions $20 \times 16 \times$
 9 in. Weight 35 lb. Price £25 4s., in oak
container; £26 5s. in walnut or mahogany.

An upright transportable receiver, en-
tirely self-contained and operated from
A.C. mains. The tuning condensers are
operated by adjacent thumb dials.

*Garnett, Whiteley and Co., Ltd., Lotus
Works, Mill Lane, Liverpool.*

o o o o

LOUD SPEAKER COMPANY.

Enemains Portable.

Five valves; two aperiodic H.F. stages,
grid detector, and two transformer-
coupled L.F. magnifiers. Single tuning
control with reaction. Dimensions $18 \times$
 17×8 in. Weight, with A.C. eliminator,

Buyers' Guide to 1930 Portable Sets.— 40 lb.; with D.C. eliminator, 31 lb. Price, A.C. model, £36 15s.; D.C. model, £31 10s.

The set is designed specifically for use with either A.C. or D.C. mains supplies, the appropriate eliminators (housed in the cabinet) being readily interchangeable; alternatively, H.T. batteries and L.T. accumulator can be used. The A.C. eliminator is for H.T. and L.T., while D.C. is used for supplying anode current and for trickle-charging an L.T. battery. Provision is made for fitting a gramophone pick-up.

The Loud Speaker Co., Ltd., Palmer Works, 2, Palmer Street, Westminster, London, S.W.1.

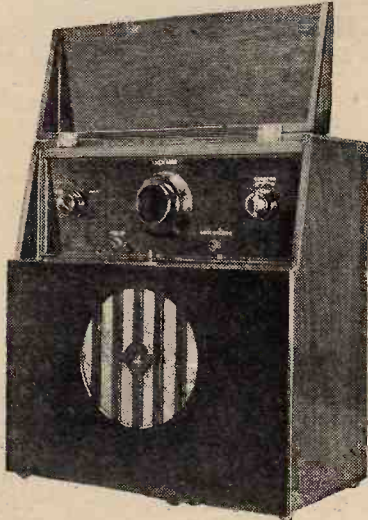

Enemains Portable.

o o o o

M.A.C.

Varsity Super Five.

Two aperiodic H.F. stages, grid detector, and two L.F. stages. Single tuning control with reaction. Dimensions 15½ × 9 × 12in. Weight 24 lb. Price £12.

A suitcase type of receiver, covered in morocco leatherette. Provision is made for the connection of a gramophone pick-up and for mains operation.

Manufacturers Accessories Co. (1928), Ltd., 85, Great Eastern Street, London, E.C.2.

o o o o

McMICHAEL.

Super Screened Four.

Two S.G. high-frequency valves, with tuned grid and aperiodic couplings, followed by a grid detector, transformer-coupled to a pentode. Single tuning control with reaction. Dimensions, 15½ × 18 × 7in. Weight 35 lb. Price £36 15s.

An upright transportable type of receiver with ganged tuning control. Volume is regulated by dimming the H.F. valve filaments. Provision is made for using an eliminator.

Super Range Transportable Four.

Circuit details similar to those of the Super Screened Four, but housed in a

table cabinet of unusual design, with an extended base, in the front of which the controls are mounted; above this base a



McMichael Super-range Portable.

loud speaker and frame aerial are built together as a unit. Dimensions 17 × 13½ × 24in. Weight 40 lb. Price £27 6s.

The receiver is intended rather for moving from room to room than from place to place.

Super Range Portable.

Four valves; S.G. high-frequency amplifier, coupled by the tuned grid method to a grid detector, which is followed by two transformer-coupled L.F. stages. Single-tuning control with reaction. Dimensions 15½ × 15 × 9in. Weight 30 lb. Price £23 2s.

Mounted in a leather suitcase. Ganged tuning of the two circuits is included, and provision is made for using an eliminator.

L. McMichael, Ltd., 179, Strand, London, W.C.2.

o o o o

MAGNUM.

Transportable Five.

Two aperiodic choke-coupled H.F. valves, leaky-grid detector followed by two transformer L.F. stages coupled respectively by transformer and resistance. One-dial tuning, loud speaker directly coupled to last valve. Dimensions

18 × 17 × 8½in. Weight 28 lb. Price, in polished mahogany, £18 18s.

The capacity of the 2-volt L.T. battery is 20 amp. hours. The total anode current is 7 mA. at 108 volts. There is provision for connecting an external loud speaker.

Suitcase Five.

Circuit details the same as that of the Transportable Five. Dimensions 15 × 15 × 9½in. Weight 27 lb. Price, in blue leatherette, £18 18s.

Burne-Jones and Co., Ltd., Magnum House, 296, Borough High Street, London, S.E.1.

o o o o

MAINS-RADIO.

M-R All-Electric Transportable Four.

The H.F. amplifier contains a Mazda AC/SG valve with parallel-fed tuned-grid circuit. Conventional leaky-grid detection with an AC/HL valve. Two L.F. stages, resistance and transformer-coupled, in that order. The output valve is transformer-coupled to the loud speaker. Dimensions 16½ × 15½ × 9in. Weight (including all-mains equipment) 45 lb. Price, including all-mains equipment and moving-coil speaker, £39 18s.



M-R All-electric Transportable.

An efficient litz-wound coil is incorporated in the H.F. stage, which is generously screened. The leaky-grid detector is followed by a variable resistance volume control, and there is provision for the connection of a gramophone pick-up.

M-R All-Electric Transportable Three.

One S.G. H.F. valve, parallel tuned-grid coupled to leaky-grid detector, which in turn is transformer-coupled to the power valve. The latter is transformer-coupled to the loud speaker. There is two-dial tuning and volume control is by means of orientation of the receiver. Dimensions 16½ × 15½ × 9in. Weight (including all-mains equipment) 38 lb. Price, including all-mains equipment and Ultra Air Chrome speaker, £29 8s.

There is provision for the connection of a gramophone pick-up. A low-loss

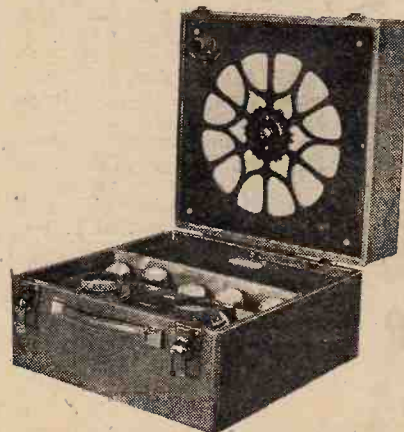

Magnum Suitcase Five.

Buyers' Guide to 1930 Portable Sets.—
litz-wound coil is used for the tuned-
grid inductance.

*Mains-Radio Mfg. Co., 42, Green
Lane, Thornton Heath, London, S.W.*

o o o o

MARCONIPHONE.

Model "55."

Two H.F. valves (triodes) semi-
aperiodically-coupled. Leaky-grid de-
tector followed by two transformer L.F.



Marconiphone "55" Portable.

stages. One-dial tuning, volume control
by reaction. Dimensions $14 \times 14\frac{1}{2} \times 7\frac{1}{2}$ in.
Weight 28 lb. Price, including turn-
table, £18 18s. Waterproof cover extra.

The total anode current is about 8 mA.
at 108 volts, and the 2-volt L.T. battery
has a capacity of 28 amp. hours.

*The Marconiphone Co., Ltd., 210-212,
Tottenham Court Road, London, W.1.*

o o o o

MINSTREL.

Type U.C. 10.

Five valves; two aperiodic H.F. stages,
grid detector, and transformer- and
resistance-coupled L.F. magnifiers (in
that order). Single tuning control
with reaction. Dimensions $15\frac{1}{2} \times 14\frac{1}{2} \times 7$ in.
Weight 24 lb. Price £16 16s.

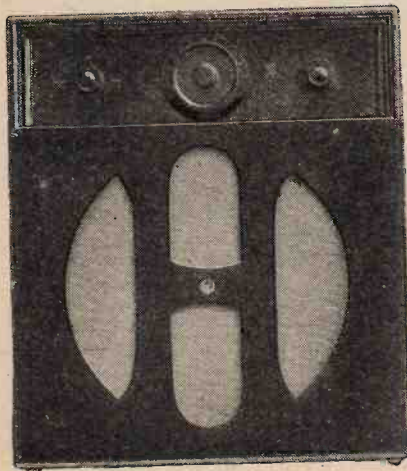

Minstrel Transportable (Harveyson).

An upright transportable receiver,
mounted in polished mahogany or oak
cabinet. A Celestion loud speaker is
fitted.

Minstrel Minor.

Two valves; grid detector, trans-
former-coupled to a pentode. Single-
tuning control with reaction. Dimen-
sions, $13 \times 13 \times 7$ in. Weight 17 lb. Price
£11 11s.

A compact two-valve upright receiver,
designed mainly for the reception of twin
Regional stations, which, it is claimed,
can be received at distances up to 35 or
40 miles. Aerial and earth sockets are
provided for use where greater range is
desired.

*E. R. Harveyson, Hatherton Terrace,
Hendon Lane, Finchley, London, N.3.*

o o o o

MONTAGUE RADIO.

Beethoven Minor.

Three valves; one triode H.F. valve
followed by leaky-grid detector and pen-
tode output. One-dial tuning and a
capacity control of reaction. Dimen-
sions $13\frac{1}{4} \times 8\frac{3}{8} \times 12\frac{1}{2}$ in. Weight 25 lb.
Price £10 10s.

The total anode current is 9 mA. at
108 volts, and the capacity of the L.T.
accumulator 15 amp. hours.



Beethoven Minor (Montague Radio).

Beethoven QCR Attaché Case.

Five valves; two aperiodic H.F. stages
followed by leaky-grid detector. Two
L.F. valves. One-dial tuning. Dimen-
sions $9\frac{1}{4} \times 15 \times 13\frac{1}{2}$ in. Weight 28 lb. Price
£22 1s.

A quasi-constant reaction circuit is
used in this receiver. Total H.T. con-
sumption 9mA. at 108 volts.

Beethoven S.G. Super-Four.

Two S.G. H.F. stages followed by
leaky-grid detector. One pentode L.F.
stage. Two-dial tuning and a capacity con-
trol of reaction. Dimensions $19 \times 14\frac{1}{2} \times 9$ in.
Weight 35 lb. Price, in walnut cabinet,
£26 5s.

The H.T. requirements of the set are
provided by a large-capacity 117-volt

battery and the total anode current is
11 mA.

*Montague Radio Inventions and De-
velopment Co., Ltd., 117, Regent Street,
London, W.1.*

o o o o

MORRIS.

Transportable.

Five valves; two aperiodic H.F. stages,
grid detector, and two transformer-
coupled L.F. magnifiers. Single tuning
control with reaction. Price £15 15s.



Morris Transportable.

In mahogany, walnut, or oak cabinet.
Safety fuses are fitted, and provision is
made for the use of a gramophone pick-
up; also for the connection of an external
aerial-earth system.

Portable.

Specification similar to that of the
Transportable receiver, except that this
set is mounted in a solid leather con-
tainer of the suitcase type. Price £12 12s.

*M. Morris (Gramophones), Ltd., 54,
City Road, London, E.C.1.*

o o o o

MURPHY RADIO.

Transportable.

Four valves; the single H.F. amplifier
contains a screen-grid valve parallel-fed

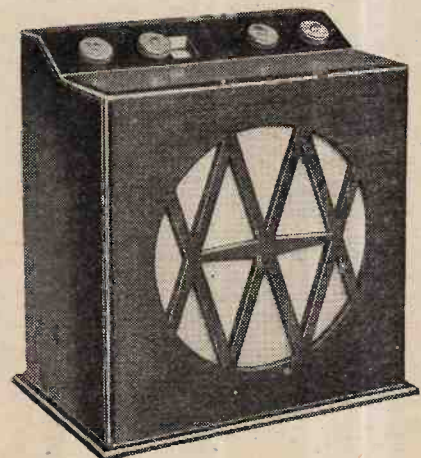

Murphy Transportable.

Buyers' Guide to 1930 Portable Sets.—
to a leaky-grid detector. There are two transformer L.F. stages. The loud speaker is directly coupled to the last valve. Provision for connection of an external loud speaker. Dimensions 16×15×10½in. Weight 32 lb. Price, including turntable, £17 17s.

The receiver is calibrated in wave-lengths and ganged tuning is used. Method of volume control is by dimming the filament of the S.G. valve. There is provision for connecting a gramophone pick-up. The total anode current is about 8 mA. at 108 volts.

Murphy Radio, Ltd., Broadwater Road, Welwyn Garden City, Herts.

NEOPHONE.

Type A.

Five valves; two aperiodic H.F. stages, grid detector, and two L.F. magnifiers. Single-tuning control with reaction. Dimensions 15½×13×9½in. Weight 28 lb. Price, in oak, £15 15s.; in mahogany, £16 5s.

Suit-case receiver, with Ever Ready H.T. and L.T. batteries. Fitted with Neophone seamless vulcanite cone loud speaker.

Type B.

Four valves; one aperiodic H.F. amplifier, grid detector, and two L.F. stages, with transformer and resistance

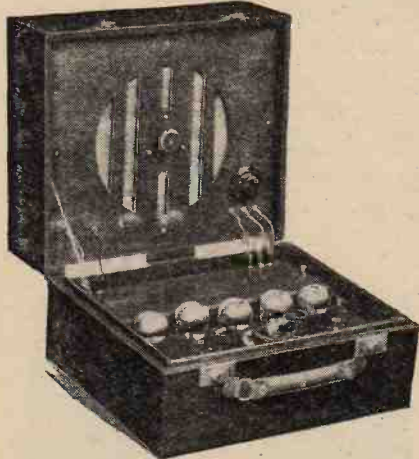

Neophone Type A.

couplings. Single-tuning control with reaction. Dimensions 13½×13½×9in. Weight 28 lb. Price £12 12s.

In polished oak container of suit-case type.

Type C.

Four valves; one screen-grid H.F. amplifier, grid detector, and two transformer-coupled L.F. magnifiers. Two tuning controls with reaction. Dimensions 16½×14½×8½in. Weight 28lb. Price £18 18s.

In polished oak suit-case. Fitted with Neophone seamless vulcanite cone diaphragm loud speaker. Tuning controls by means of edgewise dials.

The Neophone Engineering Co., 8, Garrick Street, London, W.C.2.

NULLI SECUNDUS.

Rover Screened Grid Four.

One S.G. high-frequency amplifier, grid detector, and two transformer-coupled L.F. stages; two tuning controls with reaction. Dimensions 13×15½×10in. Weight 25 lb. Price £22 1s. Provision is made for easy conversion



Nulli Secundus Portable (Creswick Atkinson).

for operation with indirectly heated A.C. valves. Anode consumption amounts to about 10 milliamps. A 22 ampere-hour L.T. cell is fitted.

All Mains Three.

The H.F. stage is coupled to a grid detector by the parallel-feed method. The output valve is a pentode, transformer-coupled to the detector. Two tuning controls, with capacity reaction. Dimensions 13×15½×10in. Weight 25 lb. Price £29 8s.

This set is made for operation entirely on A.C. mains (voltages 105-250), except that a grid-bias battery is fitted. An anode voltage of approximately 250 is applied to the pentode.

Universal Five.

Two aperiodic H.F. stages, grid detector, and two transformer-coupled L.F. magnifiers; one tuning control with reaction. Dimensions 12½×15½×9½in. Weight 23 lb. Price £16 16s.

Contained in red crocodile case, fitted with black bakelite panels.

C. Creswick Atkinson, M.I.R.E., 35b, High Street, Bedford.

o o o o

ORMOND.

Suitcase Portable.

Four valves; S.G. high-frequency amplifier, coupled by tuned anode to a grid detector, which is followed by two transformer-coupled L.F. stages. Two tuning controls, with reaction. Dimensions 16¼×13×9in. Weight 28 lb. Price £16 16s.

Fitted with Ormond 4-pole adjustable loud speaker unit and turntable. A jelly electrolyte accumulator of 23 ampere-hours is fitted.

Cabinet Portable.

Two aperiodic H.F. stages, grid detector, and transformer- and resistance-coupled L.F. stages (in that order).

Single tuning control with reaction. Dimensions 18½×14½×8½in. Weight 30 lb. Price, in oak, £15; in mahogany or walnut, £15 15s.

In upright cabinet. An H.T. eliminator may be used, and provision for external aerial and earth, and for external loud speaker, can be made at slight extra cost.

Screen Grid Transportable.

Four valves; S.G. high-frequency amplifier, coupled by tuned anode to the grid detector, which is followed by two transformer-coupled L.F. stages. Two tuning controls with reaction. Dimensions 18×14×8½in. Weight 30 lb. Price, in oak, £16 16s.; in mahogany, £17 17s.

In upright cabinet mounted on a turntable. An H.T. battery eliminator may be used.

Portable Five.

Two aperiodic H.F. stages, grid detector, and transformer- and resistance-coupled L.F. stages. Single tuning control with reaction. Dimensions 16¼×13×9in. Weight 28 lb. Price £15.

Ormond Engineering Co., Ltd., Ormond House, Rosebery Avenue, London, E.C.1.



Ormond S.G. Transportable.

P.B. RADIO.

Harmony Three.

Grid detector and two transformer-coupled L.F. stages: single tuning control with reaction. Dimensions 17×12×7½in. Weight 23 lb. Price £7 10s.

A transportable receiver in upright oak cabinet, with controls on recessed panel. Provision is made for using a gramophone pick-up, and an Exide accumulator is fitted.

P.B. Radio Co., 35, Oxford Street, London, W.1.

o o o o

PANDONA.

Standard Five, Cabinet Type.

Two aperiodic H.F. stages. Leaky-grid detector, followed by two transformer-coupled L.F. stages. One-dial tuning and a capacity control of reaction. Dimen-

Buyers' Guide to 1930 Portable Sets.—
sions 17 × 13 × 7in. Weight 28 lb. Price,
including turntable, £16 16s.

There is provision for connecting an
external loud speaker. Total H.T. con-
sumption 9 mA. at 90 volts.

Screened-Grid Four, Suitcase.

One S.G. H.F. tuned stage. Leaky-
grid detector followed by two transformer-

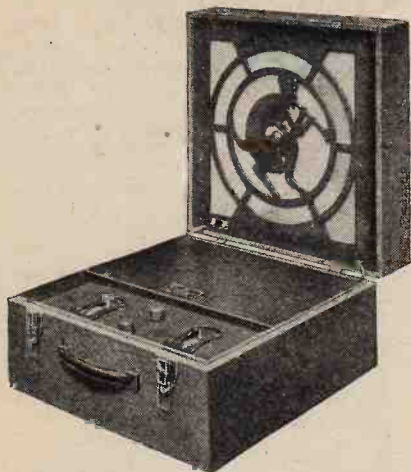

Pandona Suitcase Portable.

coupled L.F. stages. Two-dial tuning and
a capacity control of reaction. Loud
speaker fed direct from last valve.
Dimensions 17 × 16½ × 10in. Weight 32 lb.
Price, with turntable, £18 7s. 6d.

The total H.T. consumption is 10 mA.
at 90 volts, and the L.T. battery has a
capacity of 40 amp. hours.

Super Five.

Two aperiodic H.F. stages, followed
by leaky-grid detection. Two trans-
former-coupled L.F. stages. One-dial
tuning and a capacity control of reaction.
Provision for connection of external loud
speaker. Dimensions 17 × 16½ × 10in.
Weight 32 lb. Price, with turntable,
£18 7s. 6d.

A pilot lamp is provided which indi-
cates when the set is switched on. There

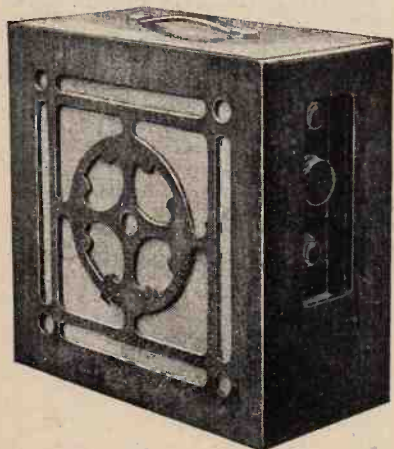

Pegasus Five-valve Portable.

is a four-volt L.T. battery having a capa-
city of 20 amp. hours. Total H.T. con-
sumption 10 mA. at 126 volts.

*Pandona, Ltd., 184, Aston Road, Bir-
mingham.*

o o o o

PEGASUS.

Pegasus "Star."

Five valves; two aperiodically coupled
H.F. stages, followed by leaky grid de-
tector; two transformer L.F. stages.
Loud speaker coupled direct to last
valve. Dimensions 16 × 16 × 8in. Weight
28 lb. Price £15 15s.

The total anode current is 7 mA. at
99 volts. The capacity of the L.T. accu-
mulator is 30 amp. hours.

Pegasus "Scout."

Five valves; same circuit as Pegasus
"Star." De luxe model, £17 17s.

*Pegasus, Ltd., Victoria Street, Chapel
Allerton, Leeds.*

o o o o

PHILIPS.

Model No. 2522.

Four valves; S.G. high-frequency valve,
coupled by tuned anode to a grid detec-
tor, which is followed by two transformer-
coupled L.F. magnifiers. Single-tuning
control with reaction. Dimensions 17½ ×
15 × 9in. Weight 47 lb. Price £27 10s.



Philips No. 2,522.

On upright transportable receiver, with
ganged tuning control operated by a
single thumb dial. Provision is made for
using an eliminator and for a gramophone
pick-up. A turntable is fitted. A water-
proof cover is also supplied with the set.

*Philips Lamps, Limited, Philips House,
145, Charing Cross Road, London, W.C.2.*

o o o o

PORTADYNE.

Portadyne Screened Grid Four.

Single stage S.G. H.F. amplifier.
Leaky-grid detector followed by two L.F.
transformer stages. Volume control by
resistance in screen-grid valve filament
circuit. Two-dial tuning and a control
of reaction. Dimensions 15 × 14 × 10½in.
Weight 30 lb. Price £23 2s. Junior
model, price £19 19s.

The total anode current is about 9 mA.
at 99 volts. The L.T. battery has a capa-
city of 26 amp. hours. There is provi-

sion for connecting an external loud
speaker.

Portadyne Regional Five.

Two aperiodic H.F. amplifiers, fol-
lowed by a leaky-grid detector. The two
L.F. stages are resistance and trans-
former-coupled in that order. One-dial
tuning and a control of reaction. Dimen-
sions 16 × 13 × 8½in. Weight 26 lb. Price
£17 17s.



Portadyne Regional Five.

The total anode current is 6 mA. at 99
volts, and the capacity of the L.T. bat-
tery 25 amp. hours. The loud speaker
is fed direct from the last valve.

*Whittingham Smith and Co., Chase
Estate, Park Royal, London, N.W.10.*

o o o o

PYE.

Model 25/C.

Five valves; two aperiodic H.F. ampli-
fiers followed by leaky-grid detector;
two transformer L.F. stages. One-dial
tuning and a control of reaction. Pro-
vision for connecting an external loud
speaker. Dimensions 15½ × 7½ × 14½in.
Weight 26½ lb. Price £19 19s.

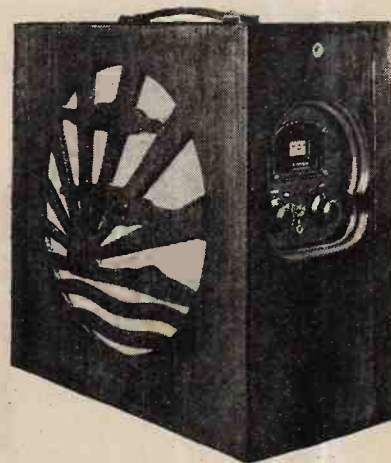

Pye Model 25/C.

Total anode current is 8 mA. at 108
volts. H.T. battery eliminator No. 924
can be supplied for this receiver at extra
cost.

*Pye Radio, Ltd., Paris House, Oxford
Circus, London, W.1.*

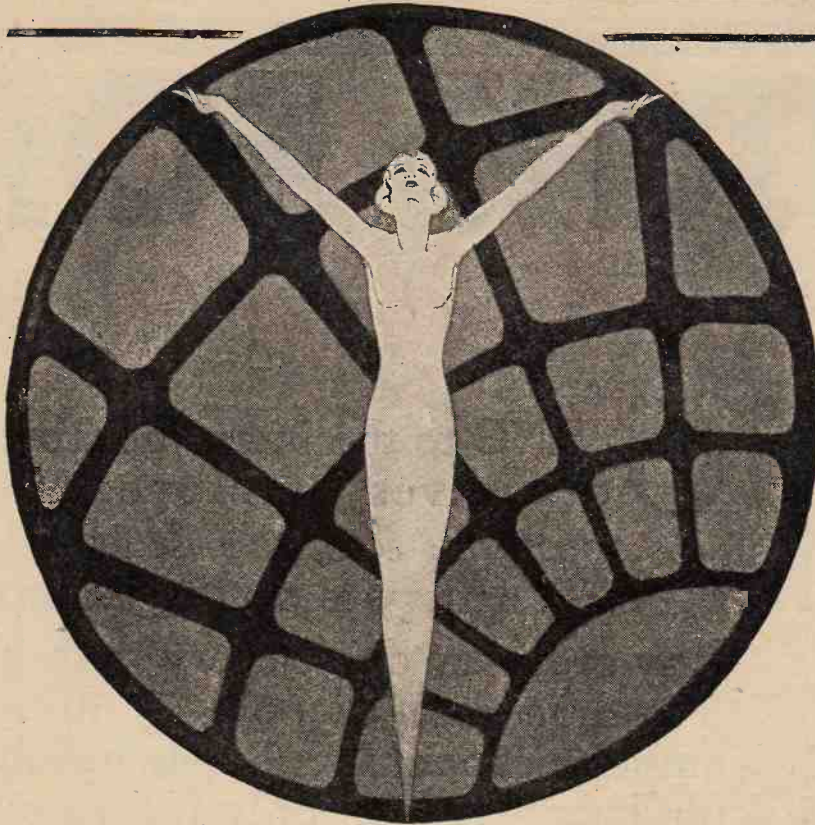

THE LURE of the ETHER

The whole broadcast waveband calls you. Enjoy its rich variety of programme at will—the ultra selectivity of the McMichael 1930 Super Range Portable Four is the key. It will bring in the station you desire with a power of volume and beauty of tone hitherto unrealized.

This magnificent Portable is perfected to a fine degree—the result of many years of radio research. Not only accomplishing a most satisfactory performance, but possessing the additional advantages of real portability and refined appearance, the McMichael 1930 Super Range Portable Four proves absolutely supreme.

Here are some outstanding details:

1. Screened Grid Amplification rendering the set highly selective and wide in range.
2. Single dial tuning and volume control making simplicity the keynote of its operation.
3. Low battery consumption ensuring economy of upkeep.

4. Fitted in a handsome furniture hide suitcase with patent locking clips which makes the set not only extremely convenient for picnics and parties, but quite suitable for the most luxurious surroundings.

The McMICHAEL 1930 SUPER RANGE FOUR (TABLE MODEL)

A model for the home where an outdoor aerial and earth are not desirable. Comprises a handsome walnut cabinet on a directional turntable, fitted with an exactly similar circuit to the suitcase Portable. The whole is completely self-contained with frame aerial and Loud Speaker ready for immediate use. An additional aerial and earth may be attached to add to the normal and very remarkable range.

Cash Price **26** GNS.

(Including all equipment and Royalties.)

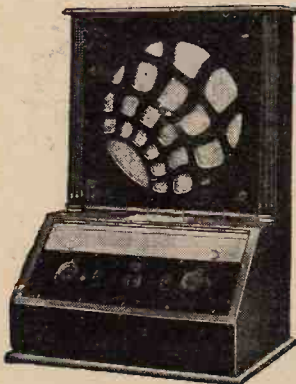

The McMICHAEL 1930 SUPER RANGE PORTABLE FOUR

Owing to the high degree of selectivity in this, and our other Screened Grid Portable Receivers, we are able to guarantee complete selectivity between all main B.B.C. stations under the new scheme of wavelengths, as proved by an actual test under the twin aerials at Brookman's Park, when both programmes were received separately without interference, and in addition a number of other British and foreign stations. This test was made on a standard "Super Range Four" receiver, under an independent Press observer, and was repeated at half-mile intervals with similar results.

Ask at any high-class radio store for a demonstration of this unique receiver—or call at our London Showrooms.

L.M. MICHAEL LTD

Manufacturers of Wireless and Scientific Apparatus
WEXHAM ROAD, SLOUGH, BUCKS.

Telephone: Slough 442.

Telegrams: Radiether, Slough.

London Showrooms: 179 Strand, W.C.2 (Telephone: Holborn 2466).



CASH PRICE **22** GNS.

Including all equipment and Royalties. Or by our special "Deferred Payments on Hire Purchase Terms" system, £5 down and 10 monthly payments of £2:1:0

PERTRIX FOR

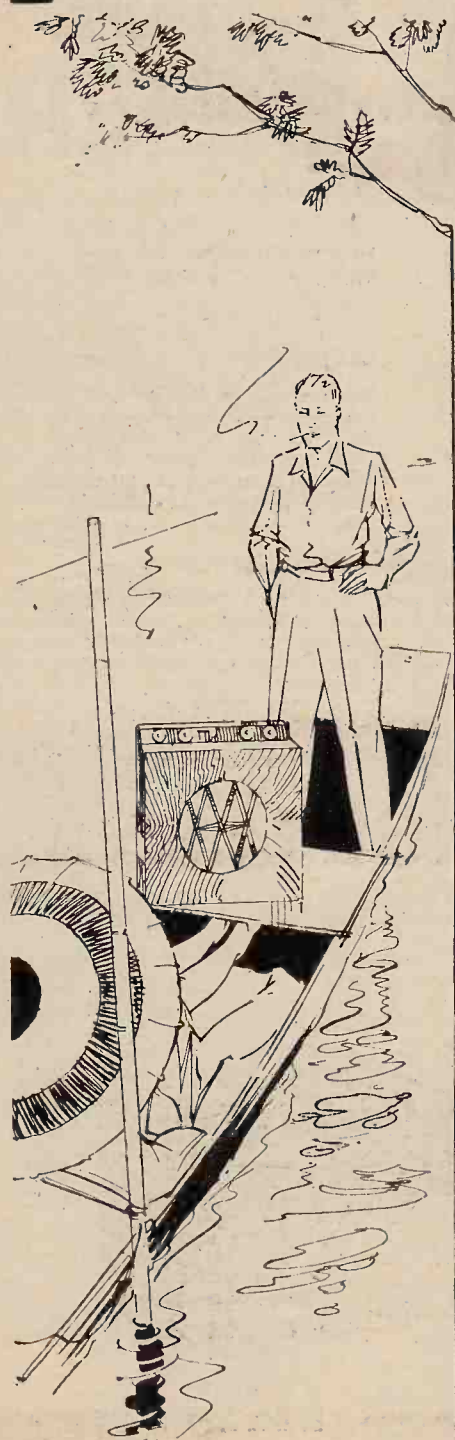

OWING to the larger number of valves employed in portable sets, the drain on the H.T. battery is much greater. Any ordinary dry battery with a discharge rate of only 6 milliamperes cannot stand up to its job for long. It lasts only for a few weeks and then dies suddenly.

That is why you want a Pertrix H.T. battery in your portable set. Pertrix *Standard* Capacity dry batteries are easily able to withstand a discharge rate of 12 milliamperes.

60% Longer Life and more

**What a
LIFE!!!**

PORTABLES!!



A Pertrix cell after 6 months' use.



An ordinary sal-ammoniac cell (taken from a battery with a discharge rate of 7 m/a) after 4 months' use.

Why the Pertrix Battery lasts 60% longer.

Look at these photographs. They show you clearly why Pertrix batteries have such an amazingly long life.

Pertrix batteries contain

NO SAL-AMMONIAC

and consequently never become corroded and choked. It is the sal-ammoniac in ordinary H.T. batteries which causes all this malignant corrosion—strangling the vital spark of life from the cells.

- BUY A PERTRIX battery for silent reception.
- BUY A PERTRIX for 60% longer life.
- BUY A PERTRIX for 12 milliampere discharge.

Ask your dealer for a Pertrix battery; H.T. Supply, Grid Bias, Flash Lamp, etc., etc.

Leaflet containing full details can be obtained by writing to Dept. B.

PERTRIX Ltd., Britannia House, 233, Shaftesbury Avenue, London, W.C.2.

PRICES

Volts.	Dimensions in inches.			Price.
	Length.	Breadth.	Height.	
* 60	8½	3¾	3¼	8/-
* 99	9¾	5¾	3¼	13/-
† 99	9¾	5¼	3	13/-
* 108	10¼	5¾	3¼	14/-
† 108	10	5¼	3	14/-
† 108	9¾	5¼	3¼	15/6
*† 126	10	5¾	3¼	21/-

* With dust-proof covers: 60v. tapped every 6v.; 99v. and 108v. tapped at 6v., 9v., and then every 9v.
 † Loose lid type tapped every 3v.
 ‡ Specially designed for "Marconi" Receiver, Model 55.
 *† Specially designed for "National" Portables.



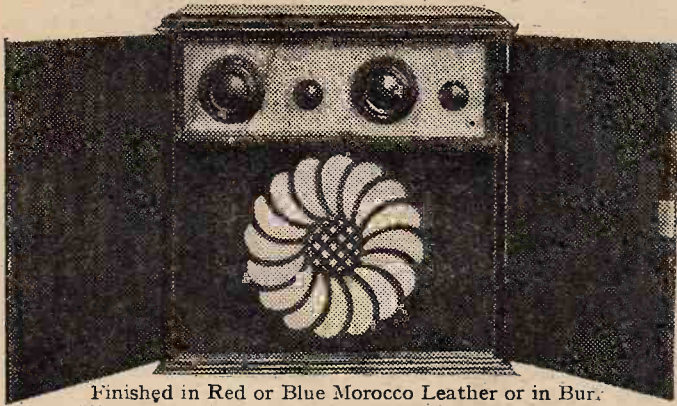

Finished in Red or Blue Morocco Leather or in Burr Wainut or Mahogany, prices vary from 40 Gns. to 45 Gns. Available also with A.C. or D.C. Mains Unit.

Our Catalogue, together with full technical details of this and other high grade models, and full details of attractive Terms, will be gladly sent on application.

RIALTON
RADIO

"The Rolls Royce of Radio"

13 & 14, Golden Square, LONDON, W.1.

THE
"MELVA"
PORTABLE

THE MOST
POWERFUL PORTABLE
IN THE WORLD

★ The "DAILY MIRROR" says of the 5 valve Portable "Melva," that "It is the finest receiver of its class."

It is a wonderful and entirely self-contained instrument employing THREE STAGES OF SCREEN GRID H.F. DETECTOR AND PENTODE, by which upwards of 40 European stations are easily received in any part of the country at full strength and exceptional selectivity.

★ Clarity of tone is obtained even at a mere whisper and music and speech from foreign stations are heard with a wealth of volume absolutely unobtainable in any other portable set produced.



REGENTONE D.C. or A.C.

"PORTABLE" COMBINED UNITS (H.T. with L.T. Charger)

A.C. MODEL

This is the model which has given such satisfaction in Portables of practically every make and every type.

MODEL W.5. Incorporates Westinghouse Metal Rectifiers on both H.T. and L.T. sides.
SIZE—9" x 5" x 3 1/4". OUTPUT—120 Volts at 15 m/a.
TAPPINGS—H.T., 2 continuously variable (one S.G.) and 1 Power. L.T.—Trickle Charger for 2-, 4- or 6-volt Accumulators.

Price £5 : 17 : 6

MODEL W.6. H.T. only, £4 : 5 : 0

Either of the above models is available for 25 cycles at an increase in cost of 10/-.

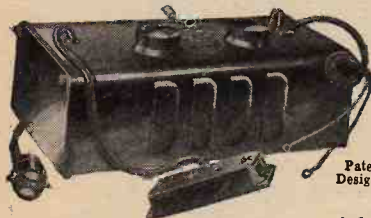

If supplied with "Xtra-Point" Loopholder and Plug, 4/6 extra.

Patent Pending Design Registered

THEY FIT
INSIDE
ANY

PORTABLE
Equally suitable
for all popular
2-, 3- and 4-valve
Receivers

Ask your dealer for demonstration or call at our London Showrooms.
ILLUSTRATED LEAFLET GIVING FULL PARTICULARS ON APPLICATION.

D.C. MODEL

—the only "Portable" Combined D.C. Unit on the market.

SIZE—9" x 5" x 3 1/4". INPUT VOLTAGE 200-250 volts.
H.T. OUTPUT—130 volts at 20 m/a.
H.T. TAPPINGS—2 continuously variable (one S.G.) and 1 power.

L.T.—Trickle Charger for 2-, 4- or 6-volt accumulators, without any alteration whatever to existing wiring.

Price £4 : 5 : 0

H.T. only, £2 : 15 : 0



Patent Pending Design Registered

REGENT RADIO SUPPLY CO. 21, Bartlett's Bldgs, Holborn Circus, London, E.C.4 Telephone, Central 8745/7

Mention of "The Wireless World," when writing to advertisers, will ensure prompt attention.

Buyers' Guide to 1930 Portable Sets.—
REES-MACE.

Tourist Seven.

Superheterodyne receiver, with screen grid signal-frequency amplifying stage, separate oscillator, and two L.F. stages. Three tuning controls and potentiometer for volume control. Dimensions 17 x 14½ x 9in. Weight 35 lb. Price £40 19s.

Provision is made, by means of a switch, to eliminate three of the seven valves for short-distance reception. The set is available in brown or blue crocodile leather containers.

Gnome.

Four valves; S.G. high-frequency amplifier with tuned anode coupling, grid detector, and two transformer-coupled L.F. amplifiers. Two tuning controls, with reaction. Dimensions 13½ x 11 x 6½in. Weight 20 lb. Price £19 19s.



Rees Mace Tourist Seven.

An extremely light and compact portable receiver, in plain hide or fancy leather case. A fuse lamp is fitted, together with sockets for the optional connection of an external aerial-earth system and head telephones.

Rees-Mace Manufacturing Co., Ltd.,
39A, Welbeck Street, London, W.1

o o o o

RIALTON.

Melva.

A superheterodyne receiver, with transformer-coupled intermediate frequency amplifier, using S.G. valves, and a grid detector, feeding into a pentode output valve. Two tuning controls, no reaction. Dimensions 17 x 18 x 10in. Weight 42 lb. Price £42.

Provision is made for the use of a gramophone pick-up and an eliminator if desired. Volume is controlled by filament dimming. Four-volt valves are used in this receiver.

Junior Portable.

Four valves; two aperiodic H.F. stages, grid detector, and one transformer-coupled L.F. stage with pentode valve in the output position. Single-tuning con-

trol with reaction. Dimensions 14 x 12 x 9in. Weight 22 lb. Price £16 16s.

A Brown loud speaker is fitted, and a fuse for the filament circuit is provided.

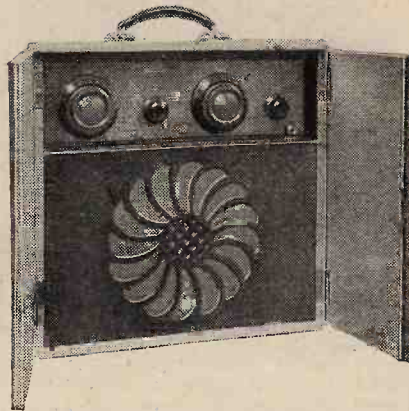

Rialton Melva Transportable.

The receiver is adaptable for mains operation.

Rialton Radio, 13-14, Golden Square,
London, W.1.

o o o o

RICARDA.

Type Z.A.5.

Five valves; two aperiodic H.F. stages, grid detector, and two transformer-coupled L.F. magnifiers. Single-tuning control with reaction. Dimensions 18 x 14 x 9in. Weight 26 lb. Price £20.

Upright transportable cabinet receiver, which can be adapted for mains operation (A.C. or D.C. supplies).

Ricarda Electric Co., 16, Holbein Place,
Stonne Square, London, S.W.1.



Ricarda Type Z.A.5.

ROLLS-CAYDON.

"Regional."

Five valves; two H.F. valves aperiodically coupled. Leaky-grid detector fol-

lowed by two L.F. stages. One-dial tuning and a control of reaction. Weight 24 lb. Price £17 17s.

The total H.T. consumption is 8 mA. at 108 volts. The two-volt L.T. accumulator has a capacity of 25 amp. hours.

"Monitor de Luxe."

Five valves; two aperiodic H.F. stages, leaky-grid detector followed by two L.F. stages. One-dial tuning and a control of reaction. Weight 25 lb. Price £19 19s.

The total anode current is 9 mA. at 108 volts, and the capacity of the L.T. battery 25 amp. hours.

"Ranger."

Four valves; one S.G. H.F. stage followed by detector and two L.F. valves, two-dial tuning, and a control of reaction. Weight 28 lb. Price £25 4s.

The H.T. consumption is 12 mA. at 108 volts. The capacity of the L.T. battery is 25 amp. hours.

"Phantom."

Four valves; two-stage S.G. H.F. amplifier followed by detector and pentode output. Three-dial tuning. Weight 33 lb. Price £34 13s.

The total H.T. consumption is 16 mA. at 108 volts, and the capacity of the L.T. battery 25 amp. hours.

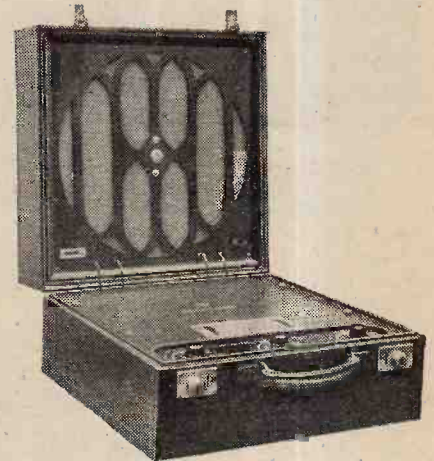

Rolls-Caydon Phantom Regional.

"Phantom Regional."

Same circuit as "Phantom" receiver. Weight 38 lb. Price £44 2s.

A high-tension battery of 120 volts is provided.

Rolls-Caydon Sales, 77, Rochester Row,
Victoria Street, London, S.W.1.

o o o o

SELECTORS.

"55" All-Mains Model.

Four valves; one S.G. H.F. amplifier with tuned anode coupling, followed by leaky-grid detector and two transformer-coupled L.F. stages. The first three valves are indirectly heated and the last valve belongs to the P625 class. Two-dial tuning and a control of reaction. Provision for attachment of external loud speaker. Dimensions 20 x 22 x 10in. Price, including all-mains equipment, moving-coil speaker and turntable, £57 15s.

Buyers' Guide to 1930 Portable Sets.—

There is provision for connecting a gramophone pick-up and an external aerial and earth, if desired. The loud speaker is filter fed from the last valve.

"42" A.C. Model.

Four A.C. valves; the single S.G. H.F. stage is tuned anode coupled. The leaky-grid detector is followed by two transformer L.F. stages. Two-dial tuning and a control of reaction. Loud speaker fed direct from last valve. Dimensions 20×19×10in. Price, for A.C. or D.C. mains, complete, £44 2s.

There is provision for connecting a gramophone pick-up and an external loud speaker. Both A.C. and D.C. models are fitted with balanced armature speaker and turntable.

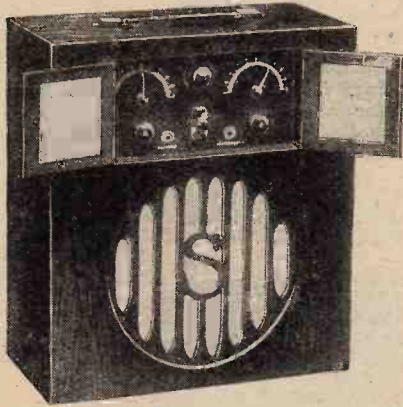

Selector Cabinet Portable.

"32" Attaché Model.

Four valves; single screen-grid H.F. stage, with tuned anode coupling. The leaky-grid detector is followed by two transformer-coupled L.F. stages. Two-dial tuning and a control of reaction. The loud speaker fed direct from the last valve. Dimensions 15½×13×8½in. Weight 28 lb. Price, in blue morocco leather, or in mahogany cabinet, £33 12s.

The two-volt L.T. battery has a capacity of 30 amp. hours, and the set is fitted with an indicator showing condition of charge. There is provision for connecting a gramophone pick-up.

Selectors, Ltd., 205-207, Bedford Avenue, Slough, Bucks.

○○○○

STIRLINGS.**S.G. Four.**

One S.G. H.F. amplifier with tuned interval coupling, followed by anode bend detection and two transformer L.F. stages. Dimensions 15½×13¼×9½in. Weight 25 lb. Price £15 15s.

There is two-dial tuning and a control of reaction. The total anode current is 8 mA. at 108 volts.

Stirlings, Ltd., 17, Clarence Street, Kingston-on-Thames, Surrey.

○○○○

TELFORD.**Portable.**

Five valves; two aperiodic H.F. stages, grid detector, and two magnifiers. Single-

tuning control with reaction. Dimensions 15×15×9in. Weight 28 lb. Price £22.

The loud speaker and aerial are mounted together; but the frame of the

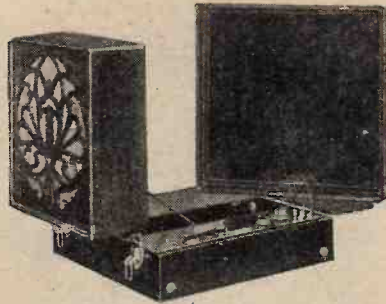

Telford Portable.

latter can be swung clear on its hinge when in a vertical position. Batteries are housed in a separate case, and an external eliminator can be used. A jack for insertion of a pick-up plug is provided.

Telford Radiogram.

Specification similar to that of the Telford Portable, with the addition of a built-in gramophone motor and record turntable. Weight 30 lb. Price £34 13s.

Hyde and Telford, Ltd., 10-14, Eccleston Place, London, S.W.1.



Stirling S.G. Four.

TRIX.**Screened Grid Four.**

S.G. high-frequency valve, transformer-coupled to a grid detector, which is followed by two L.F. stages, also transformer-coupled. Two tuning controls, with reaction. Dimensions 16×16×8½in. Weight 30 lb. Price £23 2s.

An upright transportable model, supplied in walnut or mahogany case, and fitted with turntable. The control panel, covered by a flap, is on top of the receiver. Provision is made for the use of a gramophone pick-up, and, further, a patented plug adaptor allows the use of an external eliminator.

Portable Five.

Two aperiodic H.F. stages, grid detector, and resistance- and transformer-coupled L.F. magnifiers (in that order); single tuning control, with reaction. Dimensions 17½×16×8½in. Weight 30 lb. Price £19 2s.

A patented plug adaptor allows of the connection of an external eliminator, and automatically disconnects the internal high-tension battery. A plug is provided for connection of a trickle charger. The upright container is available in walnut, mahogany, or leather. A turntable is fitted.



Trix Screened Grid Four.

Economy Portable.

Two valves; grid detector, transformer-coupled to a pentode output valve. One tuning control, with reaction. Dimensions 13×13×6in. Weight 16 lb. Price £11.

A compact receiver of the upright type, intended principally for short-range work. The container is covered in leather cloth, and access to the controls is obtained by dropping a flap in front.

All Mains Regional Portable.

Two indirectly heated valves; grid detector, transformer-coupled to the output valve. Single-tuning control, with reaction. Dimensions 13×13×6in. Weight 18 lb. Price £15 15s.

Entirely mains driven (A.C. supply) and completely self-contained. Intended primarily for local station reception.

Eric J. Lever (Trix), Ltd., 8-9, Clerkenwell Green, London, E.C.1.

○○○○

TRUPHONIC.**"Meloset" Upright Cabinet.**

Five valves; two aperiodic choke-coupled H.F. amplifiers followed by leaky-grid detector. Two transformer-coupled L.F. stages. Volume control by reaction and orientation of set. One-dial tuning. Dimensions 16×14×8in. Weight 28 lb. Price, battery-operated £16 16s., mains-operated £26 5s.

Buyers' Guide to 1930 Portable Sets.—

There is provision for connecting a gramophone pick-up and an external aerial and earth if required. The total anode current is 6½ mA. at 99 volts.

"Meloset" Suitcase.

Five valves; two aperiodic choke-coupled H.F. amplifiers, followed by leaky-grid detector. The two L.F. stages are transformer-coupled. One-dial tuning and a control of reaction. Dimensions 14½×13½×9in. Weight 28 lb. Price, in rexine £16 16s., in hide £17 17s.

The total anode current is 8½ mA. at 99 volts, and the capacity of the L.T. battery 20 amp. hours.

"Melo-Grande" Suitcase.

Four valves; one S.G. H.F. amplifier, with tuned-grid circuit, leaky-grid detector followed by two transformer L.F. stages. The H.F. amplifier is generously screened and the two tuning controls are ganged. Volume control by capacity-controlled reaction. Dimensions 14×14×9in. Weight 30 lb. Price £23 2s.

The total anode current is 6 mA. at 108 volts when a P220 valve is used in the output stage. The capacity of the L.T. battery is 20 amp. hours.

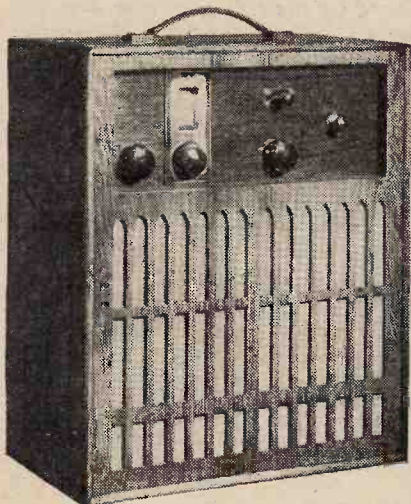

Truphonic Melo-Grande.

"Melo-Grande" Cabinet.

Same circuit as "Melo-Grande" Suitcase. Dimensions 18×15×9in. Weight 32 lb. Price, battery-operated £23 2s., mains-operated £31 10s.

Truphonic Radio, Ltd., Truphonic House, Hanover Park, Peckham, London, S.E.15.

o o o o

ULTRA.

Air-Chrome Transportable V.

Two aperiodic H.F. stages and grid detector, with transformer- and resistance-coupled L.F. magnifiers (in that order). One tuning control, with reaction. Dimensions 16×13½×9in. Weight 30 lb. Price £16 16s.

An upright cabinet receiver, fitted with a local-station rejector for the elimination



Ultra Air-Chrome Transportable V.

of interfering signals. Provision is made for using an H.T. battery eliminator.

Air-Chrome Portable V.

Specification similar to that of the transportable model, but mounted in a suitcase type of container. The feature of the local station rejector is retained.

Ultra Electric, Ltd., Ultra Works, 661-663, Harrow Road, London, N.W.10.

o o o o

WELLINGTON.

Upright Five Valve.

Two aperiodic H.F. stages, grid detector, and resistance- and transformer-coupled L.F. magnifiers (in that order). Single tuning control, with reaction. Dimensions 18½×14½×8in. Weight 30 lb. Price £15.

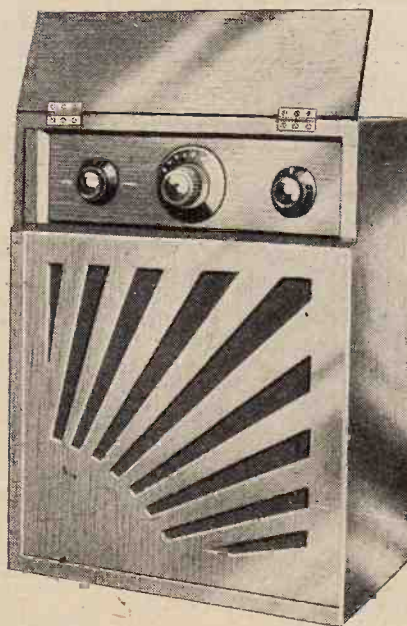

Wellington Transportable (Collings & Ayres).

An upright cabinet receiver; provision can be made for mains operation. A 30 ampere-hour accumulator cell is fitted.

Suitcase Five.

General specification as for the Upright Five Valve receiver, but mounted in a suitcase measuring 9×16×13in., and weighing 27 lb. A 20 ampere-hour accumulator is fitted. Price £15.

Upright Four Valve S.G.

Screen-grid high-frequency amplifier, coupled by tuned anode to a grid detector, which is followed by two transformer-coupled L.F. magnifiers. Two tuning controls, with reaction. Dimensions 18½×14½×8in. Weight 30 lb. Price £16 16s.

Transportable receiver with tuned H.F. amplification. Provision is made for mains operation.

Collings and Ayres, 21, The Broadway, Bedford.

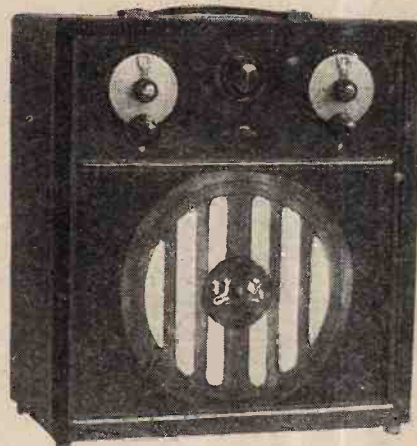

All-Mains Transportable, by Yates Sutton.

YATES, SUTTON, LTD.

All Mains Transportable.

Three valves; tuned-grid H.F. amplifier with S.G. valve, grid detector, and transformer-coupled output valve. Two tuning controls, with reaction. Dimensions 15½×14½×7½in. Weight 25 lb. Price £21.

Alternative aerial sockets are provided, one being for a short collector comprising two yards of wire, and the other for a normal aerial. When the latter is used selectivity may be adjusted by varying inductive coupling between open and closed circuits. An earth connection is unnecessary. Indirectly heated valves are used, and the set can be supplied for any standard A.C. voltage supplies.

Yates, Sutton, Ltd., 38-40, York Street, Leicester.

IN NEXT WEEK'S ISSUE.

Combining Two Loud Speakers to Cover all Frequencies.

The Band-pass Filter on the Long Waveband.



THE Portable of 2030



With Apologies to Lord Birkenhead.

By N. P. VINCER-MINTER.

REGULAR readers of *The Wireless World* may remember that in an article which appeared in the May, 1914, issue it was stated that telephony without any interconnecting wires—in other words, wireless telephony—had been achieved over a distance of several hundreds of miles as an *experimental feat*, but that it could not yet be said to have entered into the field of practical everyday service. The present writer was at that date struggling with a crystal set and a refractory spark transmitter. Had he had the sense to gaze into his crystal instead of attempting to put it to its legitimate use by prodding it with a steel point he would undoubtedly have attained to the prescience of Old Moore, and so have been in a position to foretell that in 1930 wireless telephony as an ordinary everyday service would be in operation over a distance of about 12,000 miles as the crow flies, or rather less than 8,000 miles in a direct line.

Such is the limited and conservative outlook of the body scientific, however, that his prognostications would have been laughed to scorn as incredibly fantastic, and if he had in addition made predictions concerning broadcasting, then without doubt he would have received gratuitously the attention of the two doctors which the law prescribes in such cases. It is with some trepidation, therefore, that he takes up his pen to describe the portable receiver which we shall all, by the help of Dr. Voronoff, be carrying about with us in a hundred years' time.

It is a great temptation to begin by indulging in the hoary old fatuity so often perpetrated by those whose other parrot cry is that "wireless is still in its infancy," namely, that we shall all be carrying something in our

waistcoat pockets by which we shall be able to call up any of our friends, no matter where they may be. Such a device might be possible if somebody succeeds in releasing the energy pent-up in the atom or doing something equally unpleasant, but in any case, the device would not be suitable as a portable set, as, even if it could provide ample volume and quality of sound, one would scarcely be satisfied by *the size of picture it would produce*, for naturally the 2030 portable will provide us with vision as well as sound.

The All-in Portable.

Perhaps it is best to begin with the carrying case. Whether this be made of synthetic leather, wood, or some new metal alloy, one can be quite sure that it will be almost entirely without weight, whilst at the same time it will possess considerable strength. Upon opening the lid we shall find that all that there is to be seen is a small switch panel and a plain white screen, which will occupy the same position as does the ebonite panel in the 1930 portable. Needless to say, this is the television screen, and it will probably be somewhat similar in appearance to the focusing screen of an ordinary stand camera. It will not, even remotely, resemble the present-day television peep-hole.

No loud speaker will be visible, all speech coming from the lips of the people who

appear on the screen, rather in the manner in which it should do, but doesn't, in the modern "talkie." There will be a small dial at the bottom of the picture rather resembling the instrument to be found on the present-day automatic telephone. There will be one or



"... but the 'smellivisor' would be discreetly switched off."

The Portable of 2030.—

two switches, these being mainly to cut out things which may annoy us; for instance, one can think of nothing more desirable than to cut out the portly figure of full many a prima donna whilst retaining her vocal efforts. In looking and listening to a conducted tour round a soap works one would automatically desire both sight and sound, but the radio olfactor ("smellievisor") would be discreetly switched off. It need scarcely be said that the picture on the screen will be stereoscopic, this being accomplished by the employment of two entirely separate television receivers inside the set which will give the necessary stereoscopic effect on the screen without the necessity for the "looker-in" to wear any contraption over his eyes; of course, everything will be reproduced in natural colour. Two radiophones or two loud speakers (it is even possible that we shall have found a better name for them by then) will give a stereophonic effect. "Smellievision" will be similarly treated.

Needless to say, we shall be able to tune in to any cinema or theatre we may choose, or perhaps it would be better to say tune in to any place of entertainment, as the ordinary stage will have disappeared long before 2030. All actors and actresses in that year of grace will simply be "burnt at the pit head," and they will either go through their performances each evening at the studio and their transmissions will be picked up by any theatre equipped with the necessary apparatus, or they will make sound, sight and smell films which will be distributed to the various theatres. If the first-mentioned state of affairs exists there will be a large number of studios giving performances every night, each studio having its own transmitter, and theatres will be able to take their pick. In fact, a theatre can have a different programme every night if desired, and will be able to pick them up from any country in the world. We with our portable, at home or on the river, will also be able to pick up a transmission from Melbourne or Nagasaki with the same ease as we can from London; atmospherics will be a thing of the past.

"Canned" Programmes.

If we find nothing to our liking "on the air" we shall look into a small storage compartment in our portable receiver and shall bring out a gramophone record, for, of course, our portable will not be merely a radio-gramophone outfit. But it will not be merely a sound record, nor will it be a clumsy disc capable of playing for a few minutes only. It will probably be a reel of pliable wire, or something still more simple, which we shall fit on to the small revolving spindle on the switch panel, and it will be capable of giving us a

two-hours programme of sight and sound. Similar "records" will be supplied to theatres as the managers might on a certain evening wish to put on a play which on that particular night was not being broadcast from any studio transmitter.

More T-r-roub-ble for the Telephone Girl.

Have we now exhausted all the possibilities of our portable receiver? By no means; the subject of transmission has not yet been touched upon. Our portable will most certainly contain a transmitter and we shall, if we wish to talk with a friend, merely call up the nearest telephone exchange and ask for a number in the usual way. There will then be a wireless link between our portable set and the nearest exchange, and thence our speech will go over the land lines in the usual way, unless, of course, by that time, as is more than probable, all exchanges are connected by a wireless beam which is as constricted and well defined in

its circumferential dimensions as an ordinary telephone wire. Probably so much progress will have been made in the development of the beam system that instead of the familiar array of telephone and telegraph wires carried on poles along our main roads there will be a large number of invisible beams passing across country as parallel and as close to each other as the present-day telephone wires. Undoubtedly the wired-wireless system will have been greatly developed, and

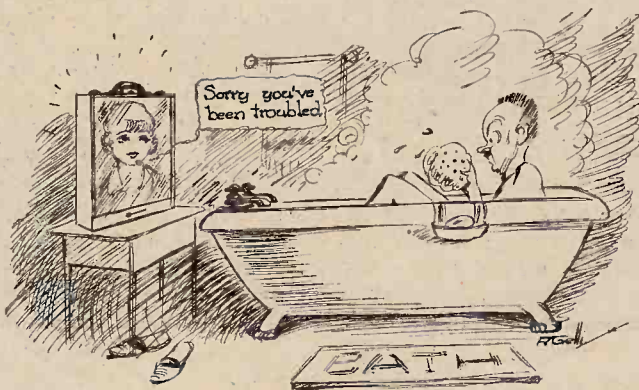

"... the telephone service will transmit vision as well as sound ..."

whereas nowadays it is possible to carry on many separate conversations over one wire without interference, it will be possible then to do the same over one "carrier-beam."

We must not forget that a century hence the ordinary telephone service will transmit vision as well as sound, and therefore we shall see on our television screen the friend to whom we are talking, and he will see us. If we feel ill we shall be able to ring our doctor and he will be able to look at our tongue on his television receiver, and listen to our pulse. X-rays will by then have been developed sufficiently to reveal our internals on a screen with the same clearness and detail as is seen to-day by the pathologist when he conducts a post-mortem examination. Our doctor will, therefore, be able to make a complete examination of us if necessary, but special means will have been invented to ensure complete privacy, possibly by some special development of the beam system which it is beyond the capacity of our 1930 minds to comprehend.

There will be no conspicuous microphone in our portable; a condenser microphone, or more possibly some undreamt of device will be at the back of the television screen.

Now, surely with all this apparatus in our portable,

The Portable of 2030.—

including stereoscopic and stereophonic receivers, a "motor" to drive the "gramophone" spindle, and a complete transmitter, the whole instrument will be extremely heavy in spite of the lightness of the case? Nothing of the kind, for in the first place all the apparatus will be made of synthetic substances of negligible weight, and as for batteries, which are the largest individual contributors to the weight of the present-day portable, they will simply be non-existent. How, then, shall we obtain our local power, for presumably a wireless receiver will still depend for its action on the "triggering off" by the distant transmitter of locally supplied energy? Certainly, it must do so, unless the power of the broadcasting stations is so greatly increased that some device like a crystal can be used for operating the sound reproducer and the television receiver direct from the power transmitted by the broadcasting station. Of course, the difficulty would be overcome if the problem of transmitting power by radio had been solved. But it is fantastic to suppose that this problem will be solved in a hundred years (it may easily be solved in much less than a thousand years), and so far we have honestly avoided the fantastic in this article.

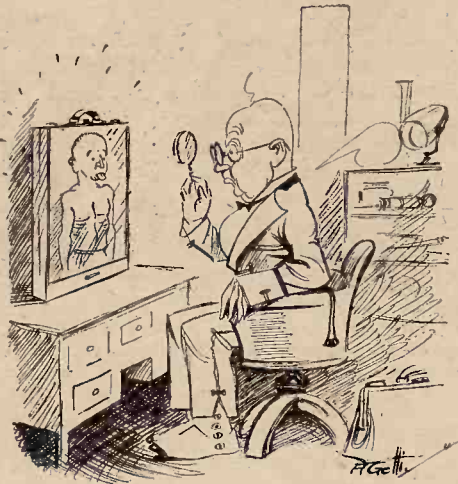

" but special means will have been invented to ensure complete privacy "

We will not even drag in atomic energy and assume that our set will derive its power supply perpetually from a split atom.

What, then, is left for us? A very simple thing; namely, the cold valve, or, in other words, the valve which has its emitting surface constructed of radio active material. One shudders when one thinks of the present-day price of radium and its derivatives, but much may be done in this branch of science before another century has rolled away. Such a valve could equally well be used in the transmitting portion of our portable, since it would not require to be a long-range instrument. It has only to put us into touch with the nearest telephone exchange—and we must assume that there will be plenty of these dotted about the country in 2030. Alternatively, the local energy required for receiver or transmitter will be radiated by the broadcasting station on a separate wavelength or separate transmitters housed in the telephone exchanges will be used for this purpose. The portable transmitter

will only be called upon to modulate and reradiate the received energy back to the nearest exchange, and it should not be a very difficult thing for the engineer of 2030 to devise a method of doing this.

PUTTING AN AERIAL ON A PORTABLE.

An Improvised Frame Transformer.

SOME portable sets are sent out by the makers with terminals or other points of connection for aerial and earth, while others have no such provision for extending their range of reception or overcoming the disadvantages of a "blind spot." With the latter type of set the user is often at a loss to know how to attach an aerial for temporary purposes and the following notes may be of interest.

A Primary Winding for the Frame.

The simplest and most universal means of overcoming the difficulty lies in converting the frame aerial of the set into the tuned secondary of a transformer, by providing a primary winding to which aerial and earth can be attached. This can be done by putting outside the case, over the frame, from one to three turns, for the short-wave, and perhaps ten for the long-wave stations. The number of turns will have to be chosen to suit the peculiarities of the set in use, the number being kept small if selectivity with more turns is too poor. If the set has but one tuning control, even a one-turn primary may reduce selectivity to such an extent that the local

station is heard "all over the dial." The addition of the aerial will, in such a case, confer no *useful* extra range whatsoever.

A Separate Frame.

To meet such a state of affairs, the primary may be converted into a loosely coupled tuned circuit. For this, the turns must be increased to ten or a dozen on a framework separate from the set, but roughly equal to it in dimensions. The station required is then tuned in on the portable by itself, and the new frame, with aerial and earth connected, is set up some feet from the set and parallel to the frame in the latter. On tuning the new frame with a condenser the station it is desired to hear will suddenly appear at good strength, while the local station will produce hardly more background than with the aerial out of use, and certainly much less in proportion to the wanted programme. By juggling with the relative positions of the set and the added coil a good deal of control over selectivity may be had, and the portable set may be given, in this way, a sphere of utility far greater than its makers intended it to possess.

REPRESENTATIVE PORTABLES REVIEWED

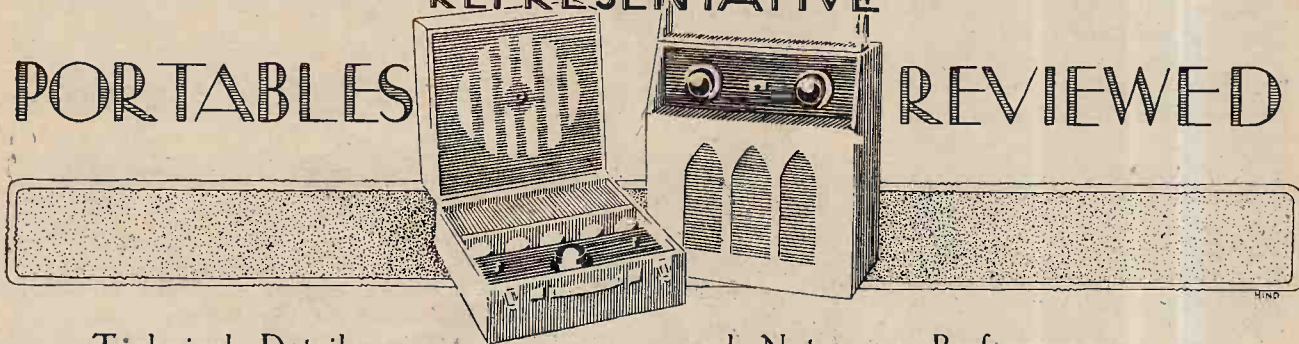

Technical Details

and Notes on Performance.

THE receivers described in the succeeding pages have been selected at random from the various groups into which modern portables may be divided. Four-valve receivers with a single screen-grid tuned H.F. stage are exemplified by the Burndept Screened Portable, while the still popular two-H.F. sets with aperiodic coupling are represented by the Columbia and Marconiphone sets. Nearly all receivers with two screen grid H.F. stages employ tuned anode coupling in the first stage and aperiodic choke coupling in the second. This principle is illustrated by the Amplion "Two Screen Grid" Portable. Finally, we have the M.R. All Electric Transportable Three, which is typical of an entirely new and promising receiver—the all-mains self-contained transportable.

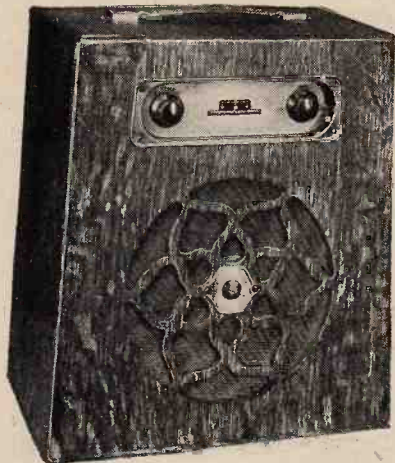

Columbia Type 303C.

A Compact and Inexpensive
Set Giving Good = quality
Reproduction.

components are carried on a horizontal paxolin shelf, and riveted strip connections have been freely used.

The cabinet is of unconventional design and tapers slightly upwards, giving the set a distinctive appearance and better weight distribution on the turntable. There are two frame aerials, the long wave being mounted inside the cabinet and the short wave on the hinged back.

An important item of the specification is the provision of a socket connector for the high-tension supply. The battery leads are connected to a four-pin plug, which may be removed if it is desired to run the set from a mains eliminator. A suitable aperture is provided in the back of the set for inserting the eliminator plug.

The quality of reproduction is very pleasing and entirely free from objectionable resonances. The bass is well reproduced, and there is sufficient response in the upper register to give crispness to speech.

Selectivity is sufficient to separate the alternative London stations and Midland Regional on short waves, but does not permit satisfactory foreign-station reception. The long waves, however, provide a sufficient number of Continental stations for those whose interest lies principally in the programmes received. On this range Radio Paris and Eiffel Tower may be relied upon to give good volume at all times, while, by making use of the directional properties of the frame to cut out 5XX, Huizen and Hilversum may be added as alternative sources of programmes. Incidentally, the two latter stations are, by a printer's error, transposed in the tuning charts supplied with the set.

THE receiver illustrated is the simplest and cheapest of the Columbia range of portables. Its compact size, $16\frac{1}{2} \times 13\frac{3}{4} \times 8\frac{3}{4}$ in., and low weight (28 lb.), coupled with the pleasing quality of reproduction, should commend it to those requiring the B.B.C. programmes with the minimum of trouble.

There are two aperiodic H.F. stages with H.L. valves and choke-coupling. These are followed by a reacting leaky-grid detector and two stages of transformer-coupled L.F. amplification, with a P.215 valve in the output stage. Solid dielectric condensers are used both for tuning and reaction, and the construction of the set as a whole has been designed for mass production. Most of the

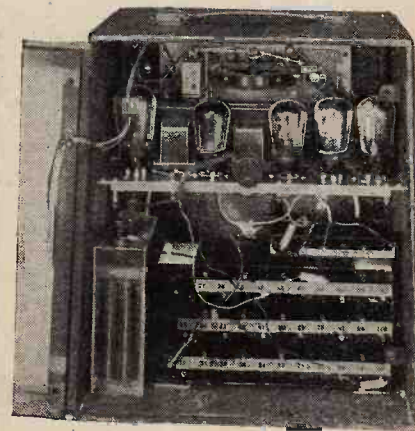

Interior view of the Columbia set.

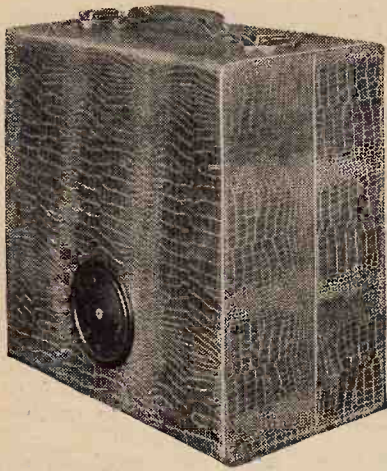

THIS year's Burndept portable is of revised design, both as regards the circuit and the details of construction. The appearance has been greatly improved, and a neater arrangement of the tuning controls has been devised.

The broad outlines of the circuit have been retained, in that there is a single screen-grid H.F. stage, followed by a leaky-grid detector and two low-frequency amplifiers, but transformer coupling is now used for both L.F. stages. Separate windings are used in the frame aerial for long and short waves, and provision is made for the connection of an external aerial and earth. The Mazda 215SG high-frequency valve is tuned anode-coupled in the conventional way with a separate fixed reaction coil fed from the detector anode through a variable condenser. The low potential end of the reaction coil is connected to +H.T. Decoupling resistances are connected in series with the anode circuit and also the screen grid. A special 2:1 transformer couples the detector (H.210) to the first L.F. valve (H.L.210) and a Mullard "Permacore" is used between the first L.F. and the Mazda P.240 output valve.

A bias of $1\frac{1}{2}$ volts negative is applied to both the H.F. and first L.F. valves, and the bias to the last valve is variable in order that a compromise may be effected between quality of reproduction and battery economy. Actually, the range of variation of the grid bias is from -10 to -18.5 volts, so that with the latter value the valve is definitely overbiased. Most people will prefer

1930 Burndept Screened Portable.

Revised Circuit and Improved External Appearance.

to work with the 10- or 12-volt tapping, as this gives good quality and the drain on the battery is by no means excessive. The measured total discharge for the set with various adjustments of the output valve grid bias were as follows: 10 v., 9.1 mA.; 12 v., 7.45 mA.; 15 v., 5.0 mA.; 18 v., 4.1 mA. Both H.T. and grid bias are derived from a special Hellesen-Burndept dry battery with suitably marked terminals. The average life is given as 200 hours.

The loud speaker leads are shunted with by-pass condensers at the receiver end to prevent H.F. currents from straying into the lid, which also contains the frame aerial. Nevertheless, the high-note response is good, and the quality of reproduction is very satisfying.

The control panel and battery compartment cover are now constructed of metal with an artistic sprayed finish. Hand-capacity effects are, therefore, negligible, the only "live" point being the aerial terminal which is situated near the wave-range switch on the left and is not sufficiently near the hand to cause trouble while tuning. Wide edgewise drum dials with slow-motion movements are placed side by side in the centre of the panel. Both dials are marked in degrees, but the left-hand dial is also calibrated approximately in wavelengths, and ample space is provided on the right-hand dial for marking the settings of important stations for future reference. After dark 24 stations

were received on short waves alone, of which 12, in addition to the B.B.C. stations, were at good programme strength. As further evidence of the sensitivity of this set on short waves it may be mentioned that Lagenberg (473 metres) could be easily received in broad daylight at programme strength. On long waves the set is

no less sensitive, and daylight reception of the five or six high-power Continental stations presents no difficulty.

A turntable is a standard item of the equipment, and with the frame set at minimum on Brookmans Park the 261-metre transmission extends from 245 to 280 metres in Central London and the 356-metre transmitter from 345 to 565 metres. With the frame set at maximum no difficulty is experienced in separating the two Brookmans Park transmissions. In London it is impossible to make use of the directional properties of the frame to assist in separating 5XX from Radio Paris and Eiffel Tower, but, fortunately, this is quite unnecessary, as the electrical properties of the circuit provide sufficient

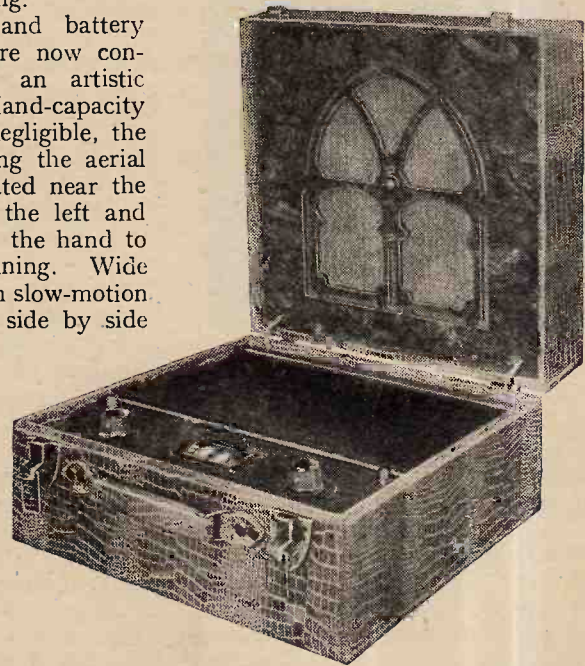

inherent selectivity for this purpose.

The new Burndept Super Screened Portable might well be taken as a model of what a well-designed portable should be, for it gains full marks on the score of range, selectivity, quality of reproduction, economy, reasonable weight, and appearance.

THE analysis of portable-receiver circuits shows that the aperiodic system of H.F. coupling is still the most popular with portable-set manufacturers. The performance of such sets as the Marconiphone fully justifies this principle, which has many other points in its favour, such as simplicity of construction, stability, and light weight. The chief criticism levelled at aperiodic coupling is that the circuits contribute nothing to the overall selectivity, which is determined solely by the properties of the frame coupled with reaction. In the Model 55 these factors would appear to provide in themselves all the selectivity necessary, for, with the frame set at minimum, the Brookmans Park transmissions do not spread more than 5 degrees on either side of their normal scale readings, while 5GB is confined to within one degree of its true setting.

Then, again, on the score of range and sensitivity the aperiodic stages provide more than the average listener demands of a portable. In addition to the three B.B.C. stations it was possible to receive Langenberg in daylight, though, admittedly, not at very great strength. After dark, however, 12 additional Continental stations were received at good strength. If anything, the long-wave range is better, and five or six stations can be relied upon after dark—four of these in daylight also.

The valves used for H.F. amplification are of the H.L. type, and the choke couplings are mounted side by side behind them. From the fact that each choke is identified, for purposes of assembly, by a coloured spot it may be inferred that their electrical characteristics differ. This measure is frequently adopted to prevent oscillation on long waves near the natural resonance of the chokes. Reaction is obtained by making use of part of the frame winding in conjunction with a variable-capacity coupling from the anode of the first H.F. valve. Thus it is the first H.F. valve which oscillates when reaction is carried too far. This has the effect of choking the set immediately the oscillation point is passed. Many portables behave in this manner, giving a weak heterodyned carrier, but strong modulation when reaction is reduced,

Marconiphone
Model 55.



A Worthy Exponent of
Aperiodic H.F. Coupling.

and in all such cases it will be found, on examination, that reaction is applied to the first valve. Where the detector is the source of reaction carrier waves and C.W. signals are generally strongly heterodyned.

The detector valve, which works on the leaky-grid principle, is mounted on sponge rubber, and under normal conditions the set is free from microphonic howling. The latter effect can be provoked by critically adjusting reaction near the oscillation point, where the set as a whole becomes hypersensitive, but in practice this condition is automatically avoided as threshold howl sets in at about the same point.

The first L.F. valve is an L. 210, followed by a P.215 output valve. Both L.F. valves are transformer-coupled.

The Marconiphone cone loud speaker is connected directly in

the plate circuit of the P.215 valves, and gives quality which is characterised by clean and crisp speech and brilliance in the upper register when receiving music. The middle and lower frequencies are, however, well represented without any undue emphasis.

A 108-volt battery supplies the H.T. current, which in the particular receiver tested amounted to 13 mA. The normal discharge is given as 7 to 9 mA. A refinement worthy of comment is the use of expanding wander plugs, both for the H.T. and grid bias connections. These effectively prevent the accidental shaking out of wander plugs—a frequent cause of trouble.

The cabinet work is neat, and the appearance is made attractive by a narrow oxidised metal control panel with edgewise dials and a sunk switch mounting. A waterproof cover is a standard item of the equipment.

And, lastly, the instruction book provides something of a surprise, for at the back is printed a price list of spare parts—surely an innovation for the wireless industry. Every part is listed down to the hinges for the door and the silk cover behind the loud-speaker fret. Portables are, naturally, more liable to be damaged than domestic sets, and owners of the Marconiphone portable are encouraged to effect minor repairs themselves to save the inconvenience of returning the set to the works.

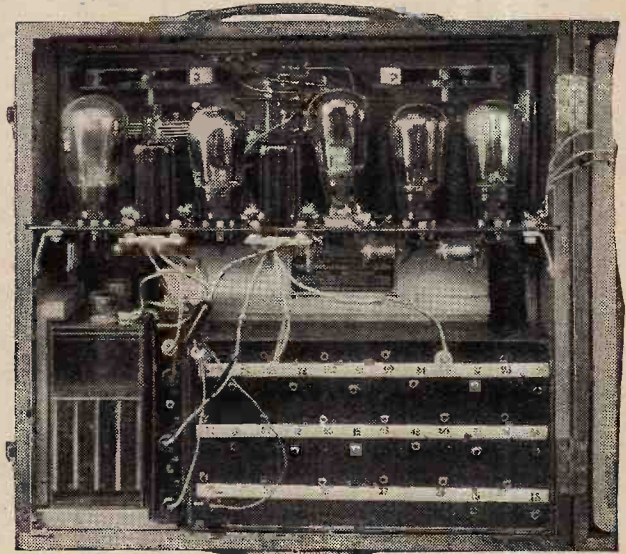

Marconiphone portable open for inspection.

Amplion "Two Screen Grid" Portable.

A Long-range Set of Neat Design and Finish.

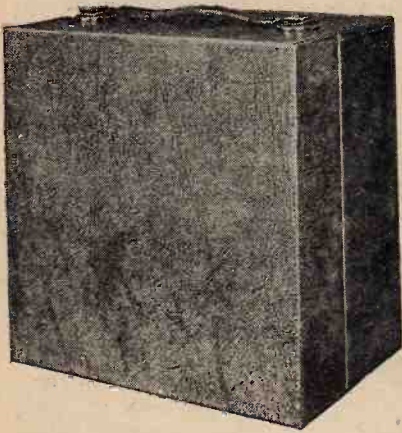

FROM a technical point of view the chief interest in this receiver lies in the use of two screen-grid H.F. stages and the methods adopted to secure stability while retaining a sufficiently high degree of high-frequency amplification to justify the use of two screen-grid valves.

In the first place, very extensive use has been made of metal screening with separate compartments to segregate the groups of components comprising each H.F. circuit. As instances of the thoroughness of the screening, we may mention that the reaction condenser is given a separate compartment to itself, and that even the loud speaker leads are screened by an earthed outer sheath of metal braid. Secondly, only one of the two H.F. stages is tuned, the other being choke-coupled; thus instability due to stray couplings between two tuned H.F. circuits is obviated. Actually, the first stage is tuned anode-coupled with a reaction coil coupled to the tuned-anode coil. The second stage is choke-coupled to the leaky grid detector.

The frame aerial connections are ingenious. There are two separate frames in the lid of the case for long and short waves. The high potential ends of each frame winding are brought out through two spaced flexible leads on the right, while the connections between the low potential ends and the receiver are made through the braided covering of the loud speaker leads on the left. The braiding, therefore, performs the dual function of screening the loud-speaker leads and completing the frame aerial circuits.

The tuning controls are mounted conveniently to the hand near the front of the case. All the condensers are separately screened, and a compound push-pull wave-range switch runs from left to right through all the compartments. Access to the valves is obtained by raising the battery compartment lid. The valves are each allocated a separate compartment, and the screening is completed by a metal plate on the underside of the battery compartment lid.

The single stage of low-frequency amplification comprises a PM22 pentode valve, coupled to the detector through a L.F. transformer. The loud speaker is connected directly in the anode circuit of the pentode, and the impedance of the windings has been specially adjusted to work efficiently with this type of valve.

The sensitivity of the Amplion portable on long waves is exceptionally high. Huizen, Radio Paris, Daventry, Eiffel Tower, Kalundborg and Hilversum were all received in daylight without reaction. By making use of the directional properties of the frame and by careful adjustment of reaction, Königswusterhausen was received at full loud speaker strength and without interference from 5XX or Radio Paris.

The general quality of reproduction is pleasing, the bass being particularly good, but the upper register might be increased with advantage. Selectivity is good, and in Central London the Brookmans Park National transmitter (261 metres) occupies a band from 250 to 280 metres, while the Regional programme spreads from 320 to 378 metres. The Midland Regional station, 5GB, is limited to within one degree on either side of its normal setting. This enables Langenberg to be received without any interference from 5GB. In all, ten Continental stations were picked up

at good strength on the medium wave range. Incidentally, the tuning dials remained closely in step over the whole of the scale, a point which greatly simplifies tuning. Another characteristic of the performance on medium waves is the behaviour of the reaction control. When this is increased beyond the oscillation point the sensitivity is reduced, with the result that strong carrier waves do not overload the loud speaker. Just below the oscillation point, however, the sensitivity returns to maximum and the reaction is smooth without backlash.

The measured anode current



drawn from the H.T. battery totalled 12.2 mA., and the makers give the life of the battery as three months.

To sum up, the Amplion "Two Screen Grid" portable should make a strong appeal to those who require sensitivity and range coupled with a degree of selectivity which will enable the high sensitivity to be usefully employed.

ALTHOUGH the portable set was introduced primarily with the idea of providing entertainment for outdoor occasions, it was soon discovered that it offered many distinct advantages for broadcast reception in the home. The ease with which it could be transported from room to room, its neat appearance, and the relief from the necessity of putting up an unsightly outdoor aerial were soon appreciated. The result is that this year we find that an increasing percentage of portables are so designed that a battery eliminator can be substituted for the dry cell battery for home use, the battery being replaced for picnics, etc.

In all receivers of this type, however, a compromise has to be made between quality and volume of reproduction and battery economy, with the result that only a small power valve will be found in the last stage. This constitutes a serious disadvantage to those accustomed to the volume and quality available from sets designed exclusively for indoor use on an outdoor aerial. A satisfactory fusion of the best features of both classes of receiver has, however, been successfully brought about in the "all-electric transportables"—an entirely new class of receiver of which the M.R. Three is a good example.

Possessing the compactness and neat appearance of the portable, this receiver is yet capable of giving reproduction of a quality and volume comparable to that of the best broadcast receivers. It is designed for operation exclusively from A.C. mains, and there are three stages, H.F., detector, and L.F. No effort has been spared to attain technical perfection in the circuit, which exemplifies the best modern practice.

The high-frequency valve is an A.C./S.G., which is coupled to the detector by the parallel feed-tuned anode circuit. The choke in the screen-grid valve anode circuit is of Lewcos manufacture, and the tuned-grid coils are wound on a ribbed ebonite former. The short-wave coil is wound with Litz wire, and the long-wave with solid wire in six sections. Due attention has been paid to spacing between the

M.R. All-Electric Transportable Three.



The Advantages of the Portable Applied to Home Broadcast Reception.

long and short wave sections and the reaction winding, which serves for both wave ranges, is located in a separate slot at a predetermined distance from each coil. Reaction is capacity controlled with a slow-motion condenser.

The detector is an A.C./H.L., functioning as a grid rectifier, the grid lead being tapped some distance down the Litz coil to prevent loading. It is followed by a Ferranti A.F.5 transformer, which feeds into an A.C./P. output valve. A resistance is connected in series with the grid of the last valve to suppress residual H.F. currents, and bias is obtained from the volt drop in a resistance connected between cathode and H.T. negative.

The whole of the circuit, with the exception of the input to the grid of the H.F. valve, is screened in a soundly constructed screening box provided with ventilation holes and a readily detachable back giving access to the valves. The screen-grid valve passes through a hole in the right-hand side of the screen, the anode terminal being inside the box and the valve base, with its grid

terminal outside, in association with the frame and tuning condenser.

The whole circuit is thoroughly decoupled with anode resistances and by-pass condensers, and the screen grid is potentiometer-fed in accordance with the best practice.

The mains transformer, full-wave rectifier valve and smoothing circuits are contained in a separate screening box at the bottom of the cabinet. The rectifier valve is easily removable, and a terminal strip for adjusting the transformer primary to the mains voltage is fitted in an accessible position on the top of the screening box. Two models are supplied, one for 100-125 volt mains, and the other for 200-250 volt mains.

The loud speaker is an Ultra double linen diaphragm, which gives remarkable volume in the bass and appears to be capable of handling frequencies at least up to 5,000 cycles. Both the back and front of the cabinet are fretted to prevent box resonances.

Excellent quality with a good reserve of volume were obtained from 5GB and the two London transmitters on short waves, and from 5XX, Radio Paris and Eiffel Tower on long waves, while the selectivity was sufficient to separate the short-wave stations with ease when only five miles from Brookmans Park.

Undoubtedly there is a future for receivers of this class, for they fulfil every need of the flat dweller and other town dwellers who are unable to erect an outdoor aerial and to whom a certain degree of portability is an additional advantage.

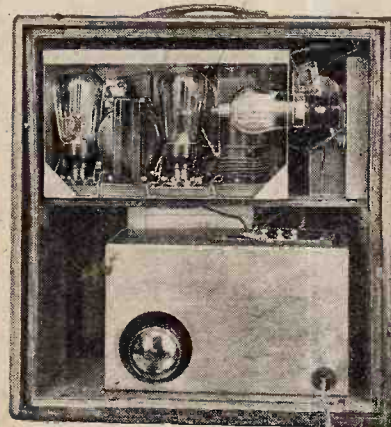

The interior of the M.R. Receiver.

CURRENT

TOPICS

**THE S.O.S. PORTABLE.**

A French experimenter has produced a special portable transmitter for attachment to motor cars. Working on one wavelength only, its sole function is to communicate S.O.S. messages to the police when accidents occur. We are not surprised to hear that the French Post Office opposes the idea on the ground that it would lead to too many transmissions.

○○○○

CZECHO-SLOVAKIA'S LISTENERS.

Twenty-five per cent. of Czecho-Slovakia's population are wireless listeners, according to the latest statistics, 284,432 licences being registered. The proportion of crystal users is 67 per cent.

○○○○

THE OLYMPIA SHOW.

This year's National Radio Exhibition at Olympia is to open on Friday, September 19th, instead of on Saturday or Monday, as in past years, and will remain open until Saturday, September 27th. Last year's most successful feature, viz., the introduction of demonstration rooms, will be repeated, and we understand that

NEW HONOUR FOR GENERAL FERRIE.

General Ferrié, the popular chief of the French military wireless organisation, has been promoted to the rank of Army Corps Commandant.

○○○○

TELEPHONING TO ATLANTIC LINERS.

A public telephone service is now in operation with the Atlantic liner *Homer* on the same conditions as with the *Majestic*, *Olympic*, and *Leviathan*. The working of this service was described in *The Wireless World* of March 5th last.

○○○○

OPPORTUNITY FOR RADIO ARCHITECTS.

A first prize of 1,000 Dutch florins (about £86) is offered by a committee at Eindhoven for the best plan for a monu-

apparatus is to be "tried out" on the 3rd battalion of the U.S. 12th Infantry. The entire "band" will be carried on a three-quarter ton truck, which will precede the marching column at a slow pace while radiating marching tunes from amplified gramophone records.

○○○○

TAXING THE AMERICAN LISTENER.

For the first time in American radio history a tax is to be levied on wireless receivers, South Carolina being the State to introduce this daring imposition. The tax amounts to fifty cents a year (about 2s.) in sets valued at fifty dollars, with proportionate increases according to value. It is reported that the proceeds are to be handed over to the hospitals.

○○○○

AEROPLANES FOR RADIO RESEARCH.

When was an aeroplane first used in this country for wireless research? In our issue of May 28th we illustrated the Ferranti 'plane which is now employed for radio tests, expressing the opinion that this was the only machine used for such work. Messrs. Alfred Graham and Co., Ltd., now advise us that a year ago they fitted the Gipsy Moth G-AACY for experimental work, and that since then G-AACY and G-AALX have both been used almost continuously in wireless experiments.

○○○○

FRENCH COLONIAL SHORT-WAVE PROJECT.

Although in broadcasting matters France has shown no tendency to outstrip Great Britain, the problem of colonial broadcasting may be more speedily settled by France than this country. We understand that the French Colonial and Postal Administrations have agreed upon a project for the establishment of a high-power short-wave station at St. Cloud, near Paris, for communication with all overseas possessions. The scheme will be proceeded with immediately Parliament votes the necessary credit. No opposition is expected.

○○○○

TUITION FOR WIRELESS DEALERS.

Wireless dealers and their assistants who have insufficient radio knowledge to perform accurate service work are catered for in a series of rapid courses now conducted at the H.M.V. Mechanics' School, Hayes, Middlesex.

The training, which should be of use to them on any make of instrument, teaches the ordinary dealer to tackle far more serious breakdowns than he is likely to experience, and the only theoretical considerations taken into account are those necessary for practical training.

An example of what the courses can accomplish is that of three men, having no electrical knowledge whatever, who recently entered the school for a five-days' training. They were given a radio-gramo-

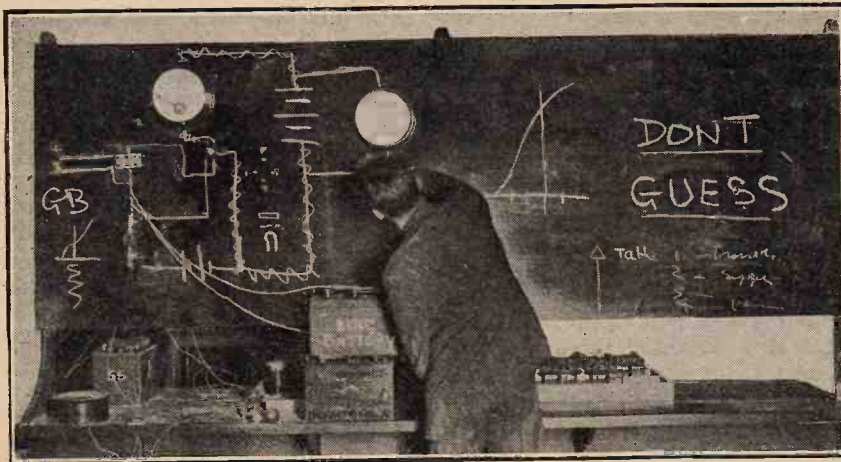

THE ELECTRICAL BLACKBOARD used in "His Master's Voice" Mechanics' School, Hayes, Middlesex. Chalk diagrams drawn on the board become electrically alive; lines light lamps, erasing a line cuts the circuit, while a battery drawn in chalk supplies current! Methods of wireless tuition for dealers are described in the next column.

at least twenty-two will be in use. Demonstrations will also be permitted on the stands, with loud speakers connected to a common output.

○○○○

MORE POWER FROM HUNGARY.

A power of at least 110 kilowatts will be used by the new broadcasting station to be established at Budapest to ensure better reception of Hungarian programmes both at home and abroad. It is proposed to fill in any remaining "dead" areas by the use of 19-kW. relay stations.

ment commemorating the invention of wireless. The second and third prizes amount to £65 and £43 respectively. Intending competitors are asked to apply for fuller details to M. J. D. Meysing, Architect, Eindhoven, Holland. The competition closes on October 1st.

○○○○

MILITARY BANDS: NEW STYLE.

The provision of a mechanical military band for drilling and marching purposes is the latest task to be entrusted to the Radio Corporation of America. According to a Washington correspondent, the

phone containing eighteen separate break-downs or faults. It is stated that each man cleared the faults in under two hours.

LYONS INTERNATIONAL RADIO SHOW.

An international wireless exhibition is to be held at Lyons from September 6th to 14th.

RADIO ON EAST-TO-WEST ATLANTIC FLIGHT.

Wireless should play a prominent part in the transatlantic flight attempt which is being made by Captain Kingsford Smith in the "Southern Cross." We understand that a start may be made from Ireland to-morrow (Thursday), the objective being New York. The plane carries short-wave apparatus for transmission on 33.3 metres, in addition to an I.C.W. transmitter for communication with ships on 600 metres. The call-sign is VMZAB.

Mr. S. W. Stainage, the operator in charge, asks for the co-operation of amateurs in the reception of the short-wave signals. Those who hear VMZAB are asked to send their reports to Mr. R. N. Bligh, 30, The Mall, Southgate, London, N., or to Mr. H. A. Clark (G 60T), 50, Rosebery Gardens, Haringay, London, N.4. The last-named will be "standing by" on 21 metres and can receive reports by wireless.

HONEYCOMB COILS.

Manufacturers of honeycomb coils in France are elated over a decision of the Paris Court of Appeal giving priority to the French honeycomb coil patent of March 3rd, 1919. This judgment renders the American patent of January 10th, 1919, null and void in France. The plaintiffs, Messrs. Standard Telephones and Cables, Ltd., lost the appeal for the reason that when their patent was taken out in France on December 3rd, 1919, no mention was made of the date and number of the corresponding American patent.

A NEW APPOINTMENT.

Squadron-Leader Hugh Leedham, who for nearly seven years has been an instructor at the R.A.F. Electrical and Wireless School, has become head of a section at the Royal Aircraft Establishment at Farnborough. In 1922, while serving in Iraq, he received an appreciation from the Air Council of his experiments with wireless on armoured cars.

GROWTH OF INTERNATIONAL BROADCASTING UNION.

Ninety million European listeners are now represented by the International Broadcasting Union, which now controls 330 broadcasting stations. This was one of the facts mentioned by Admiral Carpendale in his recent presidential speech to the General Assembly of the Union at Ouchy, near Lausanne.

Twenty-one nations, through their postal administrations or broadcasting organisations, took part in the discussions.

The Postal Administration of Portugal (Broadcasting Section) and Radio-Ljubljana of Yugoslavia were admitted to active membership, and the Columbia Broadcasting System of the United States to associate membership.



TWO-WAY TELEPHONY ON TRAINS. Wired-wireless is now used on the Canadian National Railways to enable passengers to converse with telephone subscribers in the principal cities. The photograph shows the antenna system on the Toronto-Montreal express.

The Council, having noted the progress already made, resolved that the Union should continue to work for the improvement of reception conditions in Europe, as regards both radio-electric and electrical interference, and for as simple and practical as possible a development of foreign relays, which are capable of adding considerable interest to the broadcasting programme.

Vice-Admiral C. D. Carpendale, C.B., was elected President of the Union for the sixth successive year.

FRESH START FOR INDIAN BROADCASTING.

The Government of India has completed its selection of members for the new Indian Broadcasting Board. The *Times* correspondent at Simla states the Board will have as chairman the member of the Viceroy's Council concerned, and that its other members will be two non-officials and two officials. Of the latter one will be a financial adviser, the other being selected for his administrative experience.

We trust that these appointments mark the beginning of brighter days for Indian broadcasting.

WIRELESS VERSUS PIRATES.

Recent activities of pirates in Chinese waters have drawn attention to the value of the automatic transmitter specially introduced by the Marconi Company for use on ships which run the risk of pirate attack.

By the mere closing of a switch the transmitter is set in operation and at the same time locked in its fireproof safe

while it automatically radiates the ship's call-sign and the request for assistance. This transmission continues uninterrupted until either the necessary assistance arrives or until, after some hours of continuous working, the batteries lose their charge.

The apparatus consists of the standard 1/2 kilowatt quenched spark transmitter fitted with an automatic key. Once the transmitter has been started the operator is free to abandon the cabin and join in the defence of the ship.

ANOTHER LICENCE INCREASE.

The Post Office announces that the number of broadcast receiving licences in force on April 30th last was 3,117,000.

WIRELESS AT WESTMINSTER.

(From Our Parliamentary Correspondent.)

New B.B.C. Chairman.

In the House of Commons last week, Mr. Lees-Smith, the Postmaster-General, informed Captain Peter MacDonald that the Prime Minister had recommended the Rt. Hon. John Henry Whitley for appointment by the Crown as Chairman of the British Broadcasting Corporation.

[Mr. J. H. Whitley is in his sixty-fifth year and has had a long experience in political affairs. From 1921 to 1928 he was Speaker of the House of Commons. In September last he accepted the Chairmanship of the Royal Commission on Labour in India, a task which occupied him until April.]

We understand that Mr. Whitley will take over the B.B.C. Chairmanship immediately.]

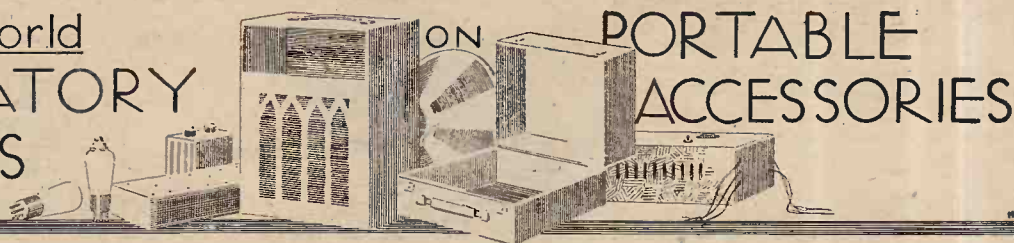
Wireless World
LABORATORY
TESTS

A Review of Manufacturers' Recent Products

R.I. NICKEL-IRON CORE TRANSFORMER AND L.F. CHOKE.

Two components which should prove particularly useful in portable sets are the "Hypermite" L.F. transformer and the "Hypercore" L.F. choke introduced recently by Radio Instruments, Ltd., 12, Hyde Street, New Oxford Street, London, W.C.1. The transformer measures $2\frac{3}{8} \times 1\frac{3}{8} \times 2\frac{1}{4}$ in. high and weighs 7 oz. Although it is small in size, it has a ratio of $3\frac{1}{2}$ to 1, and with small values of D.C. through the winding shows a primary inductance of over 50 henrys. The price is 12s. 6d.

The "Hypercore" choke is quite a new departure in L.F. choke design, since nickel-iron alloy is used for the

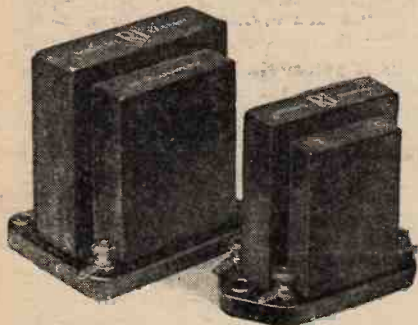

R.I. "Hypermite" L.F. transformer and "Hypercore" L.F. choke in which nickel-iron is used for the cores.

first time in the core. The result is a choke of comparatively high inductance capable of carrying 50 mA. of D.C., but weighing 18 oz. only and measuring $2\frac{3}{8} \times 2 \times 2\frac{5}{8}$ in. high. The D.C. resistance of the winding was found to be 400 ohms. Some measurements were made of its inductance at 50 cycles with various values of D.C. flowing, the results being tabulated below:—

D.C. (mA.)	Inductance (Henrys)	D.C. (mA.)	Inductance (Henrys)
0	33.2	30	31.2
10	33.0	40	28.6
20	32.5	50	24.2

The comparatively small change in inductance between 0 and 30 mA. is due to the inclusion of a small air gap in the magnetic circuit. In spite of the

expensive nickel-iron core it has been found possible to produce this choke at the very reasonable price of 17s. 6d.

NEW CLIX CONNECTORS.

In spite of the diminutive size of H.T. wander plugs to-day, there are occasions when even these take up too much head-room; this is particularly so in portable sets. To meet such cases Lectro Linx, Ltd., 254, Vauxhall Bridge Road, London, S.W.1, have introduced a wander plug, styled the "Springscrew" model, in which the prong is set at right angles to the insulated sleeve. These are available in red and black at the price of 2d. each. If desired, they can be obtained engraved at an extra charge of $\frac{1}{2}$ d. each.

An alternative model fitted with the same type of prong, but having a vertical insulated sleeve, is available where a little more head room is present. The price of this type is 2d. each also, plain, and engraved $2\frac{1}{2}$ d.

Other interesting additions take the form of "Ring" terminals, where a semi-permanent battery connection is permissible. These can be obtained either nickel-plated or lead-coated. The latter finish is recommended for L.T. battery connectors, as these are non-corrosive. These cost 2d. each in either finish, and with black or red-coloured sleeves.

If quick connection and disconnection is required, then the Clix "Hook" terminal, which retails at 2d. each, is recommended. These are finished in nickel plate, or lead-coated for accumulator connection.

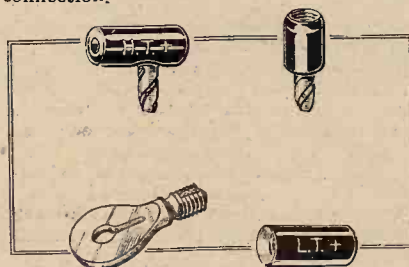

An assortment of some new Clix connectors. The "Spring-screw" wander plug can be identified by the horizontal insulated sleeve.

GREATREX PORTABLE A.C. ELIMINATOR.

Although designed especially for use in portable sets, this eliminator will serve equally well for any other type of self-

contained receiver, its small size enabling it to be accommodated inside the case in the space usually occupied by the H.T. battery. The overall dimensions are 9 $\frac{1}{2}$ in. long \times 5 in. wide \times 3 in. deep. A Westinghouse metal rectifier is used and the D.C. output taken to three separate sockets, two of which have high value variable resistances in series to provide independent control of the voltages. The remaining output socket gives the maximum voltage and is not variable at will.

A test was made on a 250-volt 50-cycle A.C. supply and the rectified voltage appearing at the fixed tapping measured at various current loads. With 2.5 mA. flowing, the output voltage was 188, with



Greatrex A.C. battery eliminator designed to fit into a portable set.

4 mA. 177, at 10 mA. 132 volts, and at 20 mA. 73 volts. The unit is intended to replace the usual 100- or 120-volt battery, and since the current demand of the average portable is of the order of 10 mA., it may be advisable to increase the grid bias on the output valve, as with 10 mA. drawn from this unit the anode voltage available will be approximately 130.

The figures given above are modified slightly when current is drawn from the two variable tappings. No doubt one will be called upon to supply the screen potential for the H.F. valve and the other will feed the detector valve, and as together these will require about 3 mA., the voltage at the 120-volt tapping will be reduced by a very small percentage.

The makers are Messrs. R. G. Greatrex and Co., 184, Regent Street, London, W.1, and the price has been fixed at £4 10s.

**"EKCO" PORTABLE SET
ELIMINATORS.**

Messrs. E. K. Cole, Ltd., Ekco Works, Leigh-on-Sea, Essex, have recently augmented their extensive range of A.C. and D.C. mains units by a new series designed for use with portable sets. The dimen-

Prices of the A.C. models are: 1.V.20, £4 12s. 6d., and C.P.1, £6. A D.C. model, 1.V.20, with output tappings for screen voltage, one variable 0-120 volts, and one giving between 120 and 150 volts,

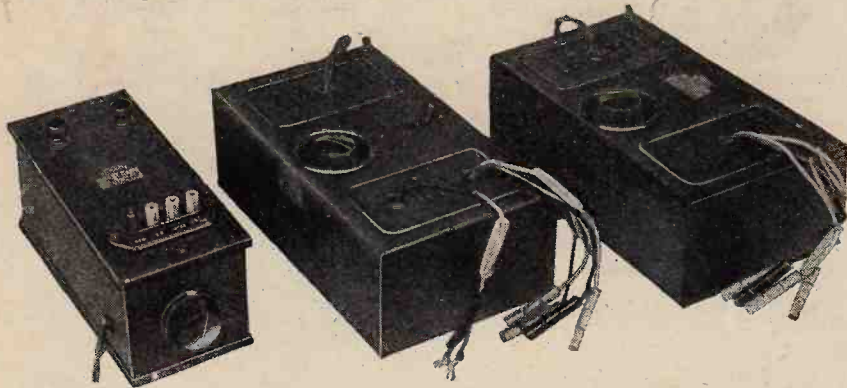

"Ekco" eliminators for use in portable sets. The A.C. models 1.V.20 and C.P.1 can be distinguished as they are larger than the D.C. model.

sions of these units are such that they will fit into the space usually occupied by the H.T. battery. Since the average portable discharges the rôle of a stationary set more often than it does that for which it was originally designed, these units will enable a larger power output valve to be used with its attendant advantages. The dry-cell battery can then be conserved for use on those occasions when the set is required to discharge its special function as a portable.

The A.C. units comprise models 1.V.20 and C.P.1, the principal difference between these two being that the latter incorporates an L.T. trickle charger for replenishing the filament accumulator when the set is not in use. Both models measure 9x5x3in. high, give a maximum output of 20 mA., and incorporate Westinghouse rectifiers.

Three separate voltage tappings are provided, two being fixed and one variable up to 120 volts. One fixed tapping (marked S.G.) gives between 60 and 80 volts up to 1½ mA. for the screen in screen-grid H.F. valves, and the other fixed tapping gives between 100 and 150 volts, according to the current taken.

A practical test showed the unit to be entirely satisfactory in use, the performance of the set being definitely improved, as more volume could be obtained without distortion. The measured output from the 100-150-volt tapping was 172 volts at 5 mA., 155 volts at 10 mA., and 120 volts at 20 mA. These values are modified slightly when current is taken from the other H.T. tappings.

These tests were made on a 240-volt, 50-cycle supply.

The L.T. trickle charger in the model C.P.1 charged a 2-volt cell at 0.27 amp., a 4-volt cell at 0.27 amp., and a 6-volt cell at 0.28 amp.

The H.T. leads must be disconnected from the set when charging, as a switch is not provided for this purpose. The inclusion of one would be a worth-while improvement.

according to load, is priced at £2 10s. The maximum output is 20 mA.

o o o o

"SURE-A-LITE" H.T. BATTERIES.

With summer definitely established and plans well under way for outdoor excursions to country, river or sea, the time has arrived to put the portable into good trim for these occasions. Unless a recent renewal has been effected, it would be worth while to test, and if necessary replace, the H.T. battery, for if this is in a partially discharged state battery trouble might quite likely arise at a most inopportune moment.

Although a standard size H.T. battery will generally fit into the battery compartment, it would leave a large waste space unless this compartment was dimensioned in the first case to accommodate batteries of the standard size. It is often found that provision is made to take a battery slightly wider than

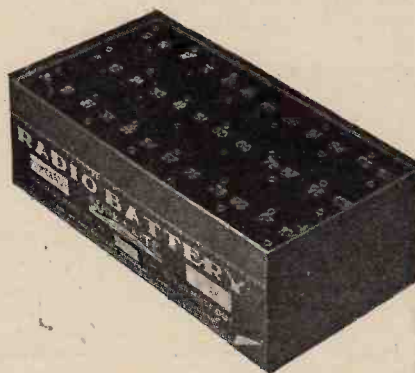

"Sure-A-Lite" 108-volt dry-cell battery for use in portable sets.

the average size, and to meet this need The Battery Co., 92, Hurst Street, Birmingham, have placed on the market some special portable set types of a more

suitable size. The two samples examined, which originate from Holland, are listed as sizes Nos. 25 and 26; the first-mentioned measures 8½in. long x 4½in. wide x 3in. high and costs 14s. It provides a maximum voltage of 100 and is tapped at intervals of 3 volts throughout. The No. 26 size is slightly larger, measuring 9½in. long x 4½in. wide x 3½in. high, and shows a maximum voltage of 108. The price of this model is 16s. 6d. This is tapped also in steps of 3 volts throughout. In addition to the higher voltage the 108-volt model gives a slightly larger capacity, so that this should withstand a heavier discharge than the No. 25 size.

**C.A.V. NON-SPILLABLE
ACCUMULATOR.**

Many ingenious devices have been adopted by accumulator manufacturers to render the cells unspillable, but possibly the most satisfactory method of approaching the problem is to use a cell in which there is no loose acid to spill. This is the policy adopted by Messrs. C. A. Vander-



C.A.V. jellied-acid portable set L.T. battery, type 2 NS 17. This is a 2-volt 20 amp.-hour cell.

vell and Co., Ltd., Acton, London, W.3, in their range of portable set accumulators. The plates are embedded in a prepared jelly saturated with acid which is of such a structure that free distribution of the gases evolved during charge and discharge is possible. Just above the level of the plates is a glass-wool pad, which serves a three-fold purpose. It arrests any acid spray that may arise during charge, replenishes the little moisture that is required to maintain the jellied-acid electrolyte in a semi-solid condition, and serves to hold the jelly in close contact with the plate. To enable the glass-wool pad to perform its allotted function it is necessary to moisten it occasionally with a little distilled water. A small quantity added once every month should suffice under normal conditions.

These batteries are made in 2- and 4-volt types, the largest variety in sizes being in the 2-volt class, which are more generally used. Prices range from 12s. for a 2-volt 10-ampere-hour cell to 16s. for a 30-ampere-hour size.

UNLIMITEX BATTERY SWITCH.

An essential feature of a battery switch for a portable set is that it will not alter its setting, even under the most violent vibration. This feature is exhibited in the Unlimitex component made by Wireless Supplies, Unlimited, 278, High Street,

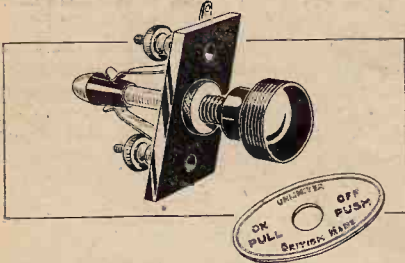

Unlimitex "snap action" battery switch which can be used also for wave changing.

Stratford, London, E.15. A small ebonite block supports two stout nickel-plated springs which are fixed in position by the terminal stems. A single-hole fixing bush is fitted. The action is positive, the plunger moving from one position to the other with a reassuring snap. At the attractive price of 8½d., it can be truly said to represent good value for money. Engraved indicating plates are supplied with every model, and these can be obtained marked "on" and "off," or "high" and "low" if required for a wave-change switch.

o o o o

JELECTRO UNSPILLABLE ACCUMULATORS.

These accumulators have been designed by the Jelectro Laboratories, 72, Bartholomew Close, London, E.C.1, to enable the maximum efficiency to be obtained from the use of their special Jelectro solid electrolyte. This substance contains a desulphating mixture and also

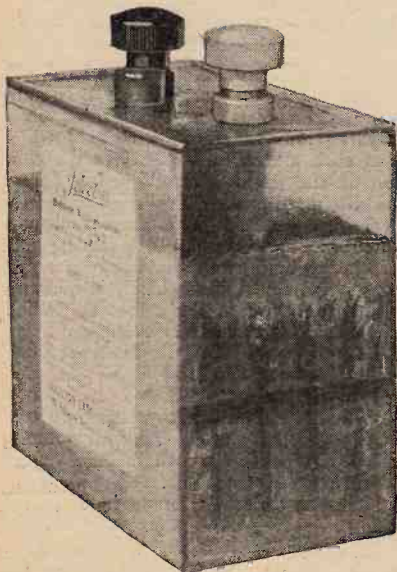

Jelectro non-spillable accumulator, type MS 60; 2 volt 28 amp.-hour capacity.

a material which precludes loss of ampere-hour capacity often associated with solidified electrolyte. Since there is no loose acid the cells can be operated in any position and they are accordingly ideal for use in portables. The top of the electrolyte is covered by a thin perforated sheet of insulating material which serves to hold the jelly in close contact with the plates at all positions of the cell.

These batteries are obtainable in sizes suitable for all well-known portables and in capacities ranging from 8 to 50 ampere-hours. The prices are according to capacity: an 8 ampere-hour 2-volt cell costs 7s. 3d., and a 50-ampere cell 19s. 6d.

o o o o

BLUE SPOT CHASSIS.

These chassis have been developed especially for portable sets, and comprise a three-ply baffle board 12in. square, in which is mounted, by means of a flexible

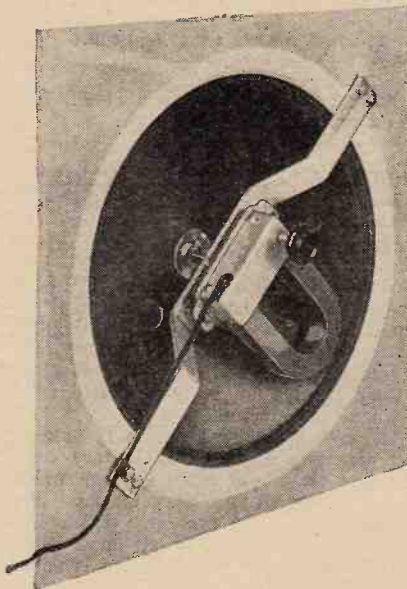

Blue Spot chassis with type 66 K adjustable balanced armature unit for use in portable sets.

surround, a shallow cone diaphragm 9in. in diameter. The well-known type 66 K adjustable balanced armature unit is employed.

In addition to the one illustrated, which has the unit mounted on the inside of the cone, there is another model, similar in general detail, but with the unit on the outside of the cone. The total depth occupied by the first-mentioned model is approximately 3½in., while the last-mentioned requires a depth of 4¾in. These are marketed by Messrs. F. A. Hughes and Co., Ltd., 204-206, Gt. Portland Street, London, W.1.

o o o o

EAGLE H.T. BATTERIES.

These batteries are made by the Eagle Engineering Co., Ltd., Eagle Works, Warwick, and in addition to the standard sizes in general use there is a special

model admirably suited, as regards size and shape, for inclusion in portable sets. This model has a maximum voltage of 90, it is tapped in steps of 9 volts between 9 and 90 volts, and thence in steps of 1½ volts to the negative end. The cells adjacent to the negative end could, if desired, be employed for grid



Eagle 90-volt H.T. battery suitable for use in portable sets.

bias. The dimensions of this battery are 8½in. long x 5½in. wide x 3in. high, and the price is 11s. 9d.

Since it is rated as a standard capacity size, the most economical discharge rate will be of the order of 8 mA., but it would be quite permissible for portable set use to discharge the battery at a slightly higher rate.

o o o o

EUREKA SWITCHES.

The body of these switches consists of an ebonite block on which is mounted the contact springs and a U-shaped metal frame carrying the actuating mechanism and a single-hole fixing bush. A short spindle passes through the centre of this bush and carries on its inside end an eccentric cam on which is mounted a small stud.

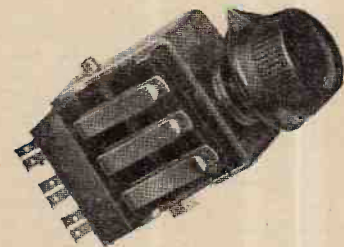

"Eureka" switch embodying a novel change-over mechanism which will resist any vibration.

On rotating the knob this stud engages in a slot and moves a paxoline-backed metal plate transversely, which, in its travel, carries the inside set of springs, causing them to contact with a similar fixed set. The action is delightfully smooth and positive.

These switches are made by Messrs. L. Persons and Sons, 63, Shaftesbury Street, London, N.1, and the prices range from 3s. 9d. for a two-pole-two-way to 5s. for a four-pole-two-way type.

CORRESPONDENCE

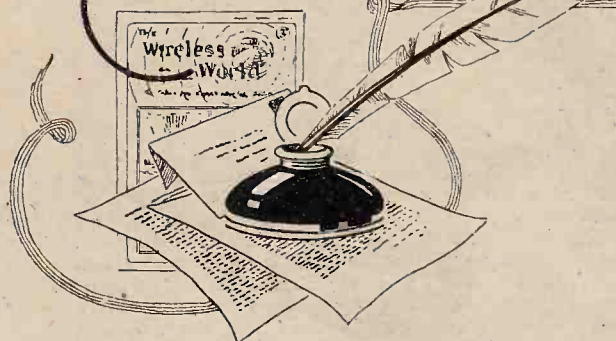

The Editor does not hold himself responsible for the opinions of his correspondents.

Correspondence should be addressed to the Editor, "The Wireless World," Dorset House, Tador Street, E.C.4, and must be accompanied by the writer's name and address.

retrograde step to have a specially designed amplifier merely to suit the Balsa wood speaker, as suggested by Mr. Paul.

The clarity of reproduction claimed by Mr. Paul is a property of any reproducer in which the higher harmonics are unduly accentuated (a well-known aural effect). In reproducing speech and music, what we desire is a faithful copy of the original.

N. W. McLACHLAN.

London, W. 1.

THE STENODE RADIOSTAT.

Sir,—Mr. S. O. Pearson has earned the thanks of readers of *The Wireless World* by his very interesting article upon the Stenode Radiostat method of reception. I cannot help feeling, however, that his ingenious attempt to reconcile stenode practice with side-band theory fails to clear up certain important points.

If the side-band theory is sound, then a carrier frequency of 1,000,000 modulated by a frequency of 1,000 results in a band of three frequencies: 1,001,000, 1,000,000 and 999,000, each of which is itself unmodulated. Therefore, nothing should be heard in telephones or loud speaker connected to a receiving set selective enough to receive any one of these frequencies without the other two. It is demonstrable, either practically or by calculation, that the "Stenode Radiostat" receiving set does possess such a degree of selectivity; yet, when it is tuned to the carrier alone, it can, and does, reproduce all audio frequencies transmitted from a broadcasting studio.

The miniature condenser in parallel with that tuning the oscillator is adjusted through a five-to-one reduction gearing, and the capacity-change effected by a complete revolution of the control knob is one micro-microfarad. To tune out Brookmans Park in London a quarter-turn of the knob suffices. The capacity-change involved is thus not more than a quarter of one micro-microfarad, an amount far too small to affect anything but the actual carrier wave. Further, the quartz crystal used in the resonator can pass a band of frequencies only a few cycles in width at the outside.

To suggest that the "stenode" receiving apparatus is concerned with "the usual side-frequencies" is something like stating that a 12in. hawser can be passed through the eye of a needle!

Mr. Pearson really cannot have it both ways. In the first column of page 530 he writes: "Besides the carrier-frequency there are always two separate component frequencies for each component or harmonic of the low-frequency wave, and when all these high-frequency components are combined there is absolutely no variation in the frequency of the resultant modulated wave." In the next column we read: "It is one of the main features of the Stenode Radiostat that the transmitting station to which it is tuned must be crystal-controlled or possess other means of ensuring that the carrier frequency is not affected by the modulation."

Surely the main point at issue is not whether side-bands exist, but whether the theory is correct in regarding them as essential for reception. The side-band theory rests chiefly upon a mathematical basis, and may not the key to the present problem be found in Mr. Pearson's own words: "It is well known that this modulated wave is equivalent to the sum of three high-frequency waves, each having a constant amplitude and frequency"?

Is it not possible that mathematics has misled us by confusing equivalents with identities? Mathematically, two halfpennies are the precise equivalent of one penny; but any smoker who, minus matches and plus two halfpennies, has stood disconsolate before an automatic machine has had convincing proof that his coins are not identical with one penny.

A modulated carrier may be the mathematical equivalent of a band of frequencies, but the Stenode Radiostat seems to show that it is not identical with such a band.

Berkhamsted.

R. W. HALLOWS.

NEWS BULLETINS FROM G 5SW.

Sir,—I have just heard the announcement from Savoy Hill broadcast at 23.05 G.M.T. to the effect that for one month, starting from 22nd inst., a news bulletin will be broadcast from G 5SW at 16.15 G.M.T., through the courtesy of Reuters and as a guide for the forthcoming Colonial Conference as to whether it is desirable to send out news from G 5SW at all.

As regards the latter reason, the wishes of listeners evidently are not to be considered, since no conference of any kind is necessary to discover what our views on the subject are. The real farce—so far as the West Indies, at any rate, are concerned—lies in the fact that reception of this courteous "geste" on the part of Messrs. Reuter and the B.B.C. will not be possible! Perhaps this is why that particular hour for sending out the news has been chosen.

Unless the B.B.C. pay no attention to criticisms on the subject of reception of 5SW they must know that in the West Indies the station is not audible until 19.30 G.M.T. as a rule, and that in any case it is only dependable between 20.00 G.M.T. and 23.00 G.M.T., owing to the combination of its power in the aerial and its wavelength. Possibly if the power was increased we might be able to hear during more hours than we can now, and certainly if the wavelength was raised by 6 metres we should be able to do so with the present power.

If the B.B.C. want to know whether we can hear the news at all, let them allow the announcer at Chelmsford—if, indeed, he is there—to read us the news at 21.00 G.M.T. as well as the programme for "two days hence," we should appreciate both considerably more than the "usual interval of about 15 minutes" and the "piano music while other stations than London give the local news, if any."

The proposal as announced to-night is a very sorry jest so far as we in the West Indies are concerned. 60° WEST.

West Indies.

NEW MOVING-COIL LOUD SPEAKER.

Sir,—I see from your issue of May 28th that Mr. Paul attributes the overpowering upper register of his Balsa wood speaker to the pick-up. It is a pity that the demonstration to a learned society was conducted under scientifically inaccurate conditions.

In the response curve, Fig. 1, of Mr. Paul's paper, the energy output from 1,000 cycles upwards is 100 times that at 50 cycles. Also, the curve shows peaks at 200, 1,000, 2,000, 3,000, and 4,000 cycles. If the disc were quite rigid, the energy would decrease rapidly above 1,000 cycles (Phil. Mag., p. 1035, June, 1929), whereas it is actually 100 times greater than at 50 cycles. Obviously, this enormous increase in output is due to resonances.

An isotropic Balsa disc without reinforcing members has its first major resonance between 300 and 400 cycles. If the disc could be made three times thicker, without increasing its mass, it would be more rigid than Mr. Paul's disc. Nevertheless, its first resonance would lie between 1,500 and 2,000 cycles, i.e., well within the audible register. I conclude, therefore, from Mr. Paul's curves and my calculations that his disc has resonances well within the limits of audibility.

In these days of amplifiers with flat characteristics it seems a

Sir,—I am interested in the description and suggested explanation of the characteristics of the "Stenode Radiostat," published in the issue of *The Wireless World* dated May 21st.

There appears to be some contradictory statements in the article. It is stated that a quarter micro-microfarad change in the capacity of the condenser tuning the local oscillator is sufficient to tune through a station. It is concluded that, when the "Radiostat" is receiving a transmission, a capacity change of less than one-eighth micro-microfarad is insufficient to reduce the audio output to a negligible amount. I calculate this to represent a frequency change of some ten kilocycles.

If the above be true, there will be an appreciable audio output when the carrier frequency is removed by one kilocycle from the difference in frequency of the local oscillator and quartz selectivity peak respectively; it is assumed that the frame aerial circuit decrement is too large to necessitate consideration.

Again, using the audio high pass filter, adequate compensation is claimed for the high note loss due to extreme selectivity. Surely this compensation is applicable to interfering frequencies within five kilocycles of the desired carrier frequency? Then how does the device eliminate undesired carriers one kilocycle off tune, as claimed in the beginning of the article?

Towards the end of the article it is suggested that the radiostat does not respond to heterodyne interference because the resulting wave form may be resolved into not more than two sine waves. Does this mean that the "Radiostat" cannot be used for reception of single side-band and carrier? It appears so.

The writer of the article states that when a wave, resulting from the addition of interfering frequency and desired frequency (carrier), is fed into the "Radiostat," it undergoes frequency modulation and thus produces no audio output. I understand this to mean that there is, resulting from this frequency modulation, an audio output which is equal in amplitude and frequency to the ordinary heterodyne note, but bearing a phase relationship of 180° to the latter; and that the addition of a suitable sine wave, on the other side of the carrier, prevents frequency modulation and results in an audio output in phase with, and equal in amplitude and frequency to, the heterodyne note, i.e., carrier and single side-band, on de-modulation, do not give an audio output, but carrier and both side-bands do so.

Testing Short-wave Sets.

It is, of course, impossible to have a constant source of short-wave entertainment always available, and in order to have some provision for testing a short-wave receiver when conditions are bad or no stations are on, an ingenious form of short-wave local oscillator was described by Mr. Thompson at a recent meeting of the Muswell Hill and District Radio Society. Low-frequency signals from an adjacent broadcast set are caused to modulate the oscillator, thus putting a transmission always on tap.

A Visit to the "B.P. Twins."

What might well be termed the crowning event of the syllabus of the Muswell Hill and District Radio Society took place on May 24th, when members paid a visit to the Brookmans Park transmitting station.

The main transmitting hall was first toured, and the symmetry of the layout of the two transmitters greatly impressed the visitors. It was gathered that over 150 kilowatts input can be used, while the usual output is 30 kilowatts at 15 amps. in the aerial.

The power house was next visited, and the great D.C. generators, believed to be the only ones of their type, were of particular interest. In an adjacent engine room are several Diesel engines driving these generators, the crude oil being contained in two huge 75-gallon tanks.

Hon. Secretary, Mr. C. J. Witt, 39, Coniston Road, N.10.

When Comparisons are (Mel)odious.

A comparison of sets, modern versus old, was carried out at a recent meeting of Slade Radio (Birmingham).

The first (Mr. R. Heaton) was a three-valve set of an old type with plug-in coils, detector and two L.F., one R.C., and the other transformer. At one time used with D.C. mains it had since been adapted for A.C. With a Celestion speaker the set gave a very creditable

I consider this theory a trifle vague, and I trust that elaboration of the present theory, or a more satisfactory explanation of the Stenode Radiostat characteristics, will be published in the near future, either in one of the excellent *Wireless World* articles, or through the medium of your Correspondence column.

REGINALD V. ORTON.
London, N.20.

Sir,—Referring to the recent "Stenode Radiostat" article, there is a suggested explanation of the effects obtained with a heterodyne note. The author suggests that the combination of two carrier waves produces a third wave of varying frequency, but if this is the case power must be absorbed from the two fundamental waves in producing this third vibration. This can be disproved by the fact that the presence of heterodyne effect would reduce the power of the two transmitters at the receiving point by the power needed to create the separate wave. No such reduction of power exists, and I, therefore, submit that a heterodyne wave does not exist as such, but that the phenomena experienced is due to the simultaneous existence of each separate wave in the tuning apparatus of the receiver. To put it another way, the heterodyne wave does not form in the ether, but in the tuning coils of the receiver.

As a reader, and, I must admit, an admirer, of *The Wireless World*, I must deplore the attempt to retain the side-band theory as a satisfactory explanation of existing phenomena. I think it is time this theory was relegated to the position of a useful supposition which simplifies both the mathematical side and the application of wireless theory. The suggestion that side-bands are received on the "Stenode Radiostat" because each pair together form a wave of fundamental frequency is quite satisfactory until one tries to receive the side-bands independently. If side-bands really existed this super-selective receiver would still be able to receive them some way from the fundamental on either side, reproduction being high-pitched and unnatural, and lacking the lower frequencies which are supposed to cling to the fundamental.

I suggest that the term "side-bands" is now obsolete, and that it is better and more correct to speak of "splitting a wave into its component parts" for the purpose of more convenient handling.

Combe Martin.

M. H. JARVIS.

NEWS FROM THE CLUBS.

performance. The second (Mr. A. Freeman) was a modern set, screened grid, detector and two L.F. Various differences were described, and the set on demonstration gave good reproduction and volume. Then followed a Kilo-Mag Four (Mr. C. J. S. Jones). Descriptions were given of the slight alterations which had been made in the original specification, with hints on construction. With a Marconi speaker the reproduction was found to be quite good and the volume ample. The comparisons proved very interesting as well as instructive.

Details of the Society and future programme may be obtained from the Hon. Secretary, 110, Hillaries Road, Gravelly Hill, Birmingham.

D.F. Competitions for All.

On Sunday, May 25th, an instructive day was spent near N. Minnis by members of several London societies. A small transmitter, owned by the Golders Green and Hendon Radio Society, was set in operation in the middle of some open country and direction-finding groups from several radio societies circled around it, at a distance of about three-quarters of a mile. The objects of the tests, which lasted several hours, were: (a) to test the efficiency of the set, (b) to take visual bearing on the transmitter, and thereby discover any constant error in the apparatus used, (c) to ascertain what quadrantal error would arise by placing the direction-finding apparatus permanently on a car, (d) to help beginners with their apparatus. Unfortunately, the weather prevented the com-

pletion of the tests, but it was found that in the case of a set mounted on the rear of a two-seater Wolseley car there was no quadrantal error on the wavelength used.

One group had designed a most ambitious and effective set. They used one stage of high-frequency amplification, using an indirectly heated screen-grid valve. The set was fixed to a small car. By means of a small aerial, in conjunction with the frame aerial, and a compensating coil in the set, a method of determining absolute direction was available.

On Sunday, July 6th, the Golders Green and Hendon Radio Society will organise a direction-finding competition near London, open to any radio society member. Five radio societies have already promised co-operation. Those interested are invited to write to Lt.-Col. H. A. Scarlett, D.S.O., 60, Pattison Road, N.W.2.

Commercial Sets Demonstrated.

The last meeting of the Bec Radio Society's winter session was the occasion of a demonstration of two commercial receivers. Mr. G. E. Ward, of Gramo-Radio Amplifiers, Ltd., brought an "All Mains Radio Gramophone," of the type reviewed in *The Wireless World* for February 26th, 1930. The instrument incorporated indirectly-heated Mazda A.C. valves, a Truvox pick-up, and a Magnavox moving-coil speaker. The results obtained on both broadcast and gramophone records were decidedly good at all frequencies.

The second demonstration was kindly arranged by Messrs. Selectors, Ltd., and was conducted by Mr. G. Rickardson, of that firm, with a model of the company's all mains transportable receiver. Numerous Continental stations were received at good strength.

The summer session of the Society has already commenced, and any persons desirous of becoming members are requested to communicate without delay with the Hon. Secretary, Mr. A. L. Odell, 171, Tramere Road, S.W.18.

Tours Round Brookmans Park

Radio sightseers are now flocking in little parties to Brookmans Park on Saturday afternoons between 3 and 5 o'clock, the hours officially set apart for conducted tours round the twin broadcasting station.

The conducting is done by the ever-courteous and patient engineers whose pride in their station fortifies them for the task of explaining technical apparatus to non-technical people.

o o o o

Apply Now for Autumn Permits.

Fortunately, the general standard of technical knowledge has risen considerably in the last year or two, and the engineers are rarely confronted by the pre-broadcasting type of novice who wants to be shown a volt.

To join these parties a permit must be obtained from the Chief Engineer. The demand for this privilege has already been very great, and I understand that no permits are now available for visits before the end of October.

o o o o

Scottish Regional.

The Falkirk site is now practically decided upon as the best position for the Scottish Regional station, and I hear that the B.B.C. is now approaching the Post Office for permission to go ahead with the first stages of construction.

o o o o

Doomed Transmitters.

This piece of news sounds the death-knell of the stations at Glasgow, Edinburgh and Dundee, though it would not be surprising if the Aberdeen transmitter were retained.

All the existing studios in Scotland will be kept for the occasional broadcasting of local concerts and news.

o o o o

M.P.s at Savoy Hill.

There were impressive moments at Savoy Hill a few days ago, when a deputation of Midland M.P.s met the entire B.B.C. Board of Governors in order to present a mysterious looking box containing a petition signed by 30,000 listeners in the Birmingham area. The signatories were pleading for the retention of the Birmingham studio orchestra.

o o o o

The Chairman's Answer.

Lord Clarendon handled the situation in a statesmanlike manner, assuring the deputation that, whatever happened to the orchestra, the Birmingham studio would more than satisfy the musical demands of the Midland region. This answer appeared to satisfy the M.P.s, though on the vital principle of centralisation, which has caused all the trouble, His Lordship was silent.

o o o o

A Musical Jig-saw.

In spite of the monster petition, the B.B.C. intends to go ahead with the centralisation policy. It seems to me that Birmingham listeners need have little to regret. With the new National Orchestra of 114 players, it will be possible to allocate a section of players—all the chief

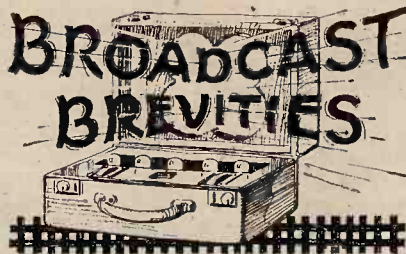

By Our Special Correspondent.

instruments will be duplicated—for separate performances relayed to the various transmitters.

o o o o

Splitting Up the Orchestra.

London, for instance, may be sending out a symphony with 78 players, while the Midland transmitter broadcasts a selection by a theatre orchestra of 36. Similarly, a light orchestra of about 60 may entertain London listeners, while an alternative transmission provides a Mozart programme with about 46 players, yet another transmitter supplying music by an octette.

o o o o

Saving £11,000.

The only trouble likely to arise is in regard to land-line transmission. Midland listeners will be entitled to argue that a mediocre performance in their local studio will be superior to the finest effort coming over the land line from London.

The B.B.C.'s aim is admittedly towards economy. I hear that the present orchestral arrangements entail an annual expense of £87,000. The proposed National Orchestra will be run at a yearly figure of £76,000, leaving £11,000 for improvements in other directions.

Prince of Wales as Broadcaster.

In addition to his broadcast to-day (Wednesday) from Glasgow, the Prince of Wales will also be heard in the National programme on July 6th, when His Royal Highness attends the dinner of the National Union of Students at the Savoy Hotel.

o o o o

Chinese Orchestra at Savoy Hill.

The B.B.C. programme sleuths have recently been haunting the Chinese quarter of London in search of artists for a Chinese programme. I hear that the result is the formation of quite a pretentious Chinese orchestra which we shall be able to hear on June 16th.

o o o o

Running Commentary on the T.T.

A running commentary on the Senior International Auto Cycle Tourist Trophy Race, relayed from the course in the Isle of Man, will be broadcast on June 20th from 12.45 to 1.45 p.m. This is the first time that a commentary on the event has been broadcast. There will be two commentators—Mr. B. H. Davies, of our sister journal, *The Motor Cycle*, will speak from the Grand Stand, and Major Vernon Brook will speak from the Craigna-Baa Hotel.

The commentators will not need to "manufacture" thrills; I expect many listeners will be sorry when the hour is up.

o o o o

Queen Elizabeth at the Microphone.

The first night of the Aldershot Command Searchlight Tattoo, which will be broadcast on June 17th, will enable listeners to hear 1,000 musicians and 5,000 voices. Among the items to be broadcast are light cavalry evolutions, a pageant of the Battle of Dettingen, and a pageant of Queen Elizabeth reviewing her troops.

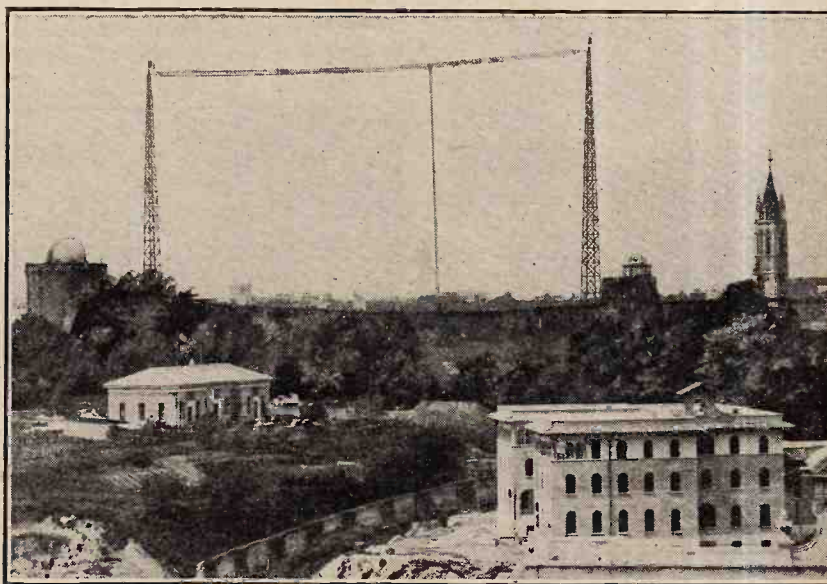

A PAPAL BROADCAST? An impressive view of the new Marconi short-wave station at the Vatican City. It is considered probable that the Pope will celebrate the Feast of St. Peter and St. Paul at the end of this month by a personal talk at the microphone, in which case the B.B.C. might endeavour to relay the speech to British listeners.

READERS' PROBLEMS.

"The Wireless World" Supplies a Free Service of Technical Information.

The Service is subject to the rules of the Department, which are printed below; these must be strictly enforced, in the interest of readers themselves. A selection of queries of general interest is dealt with below, in some cases at greater length than would be possible in a letter.

A Helpful (?) Neighbour.

My det.-2 L.F. set normally works quite satisfactorily, but very often I am troubled by severe distortion, particularly when receiving the London programmes. This distortion seems always to be accompanied by a considerable increase in signal strength over and above the normal level; signals are, indeed, so loud that they can often be received with the aerial disconnected from its terminal.

Can you suggest the cause of, and a cure for, this trouble? H. D. N.

Your concluding statement seems to provide a clue. At your distance (nearly 200 miles) from London it is almost inconceivable that either of the twin stations could be received in the normal way without the help of an aerial on a det.-L.F. set, and we expect that reception is being helped by reradiation from a neighbouring aerial connected to a set that is in a state of self-oscillation.

o o o o

A Shorted Condenser?

Can you suggest a reason for my failure to get a grid rectifier to work unless a negative bias of 4½ or 6 volts is applied to it? The set, which is a det.-2 L.F. combination, has never worked really well, and until I tried the effect of changing grid voltage it was impossible to do more than receive the local station. K. F. P.

We think that the only logical explanation for this effect is that your grid condenser is short-circuited internally or externally. If this is so, the conditions necessary for grid rectification do not exist, and, consequently, it is natural that

detection can only be obtained by impressing a negative voltage on the grid.

Of course, you would hear the local station under almost any conditions, because a certain amount of rectification of strong signals is always produced by the natural curvature of the valve characteristic, and in other ways.

o o o o

Slaves to Fashion.

I am designing a 4-valve portable (H.F.-det.-2 L.F.), and have reached a stage where the control panel lay-out is to be settled. It seems that all sets without exception, whether commercial products or designed for home construction, are arranged with the input or aerial end on the left-hand side of the receiver. Would there be any objection to reversing this course of procedure? My reason for wishing to do so is that I am using a pair of tuning condensers controlled by side-by-side edgewise dials, which are to be operated with one hand. Experience leads me to believe that it is much easier to manipulate this form of control with the right hand than with the left. Any advice or suggestions as to panel layout will be welcomed.

S. P. G.

It has become conventional to build all our sets with the input end on the left (when looking from the front), and perhaps it is as well that a standardised procedure has been agreed to, or, rather, accepted as an unwritten law. We must

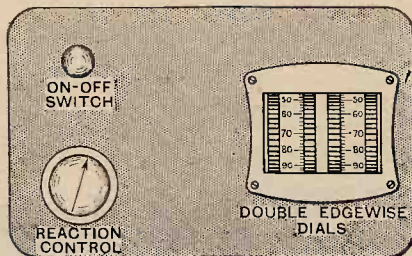

With tuning controls on the right: suggested panel layout for a portable in which adjacent edgewise condenser dials are used.

admit, however, that there is a great deal to be said in favour of your proposal to ignore this convention and to reverse the lay-out of your receiver; it is probably easier, as you say, to operate the "semi-ganged" drum dials with the right hand, but it must not be forgotten that many portable receivers depend very largely on reaction, and in your case this control, which may be even more critical, will have to be manipulated with the left hand.

From the electrical point of view, there

is not the slightest reason why the receiver should not be arranged as you suggest, and we append a sketch showing a suggested form of layout for the control panel.

o o o o

Detector Anode Current.

I have recently obtained a multi-range milliammeter, and, much to my surprise, find that my detector (which works on the grid circuit principle) consumes no less than 10 milliamperes. Surely this is abnormal. Will you tell me what to do? A. G.

This current is certainly excessively high. A grid detector need consume no more than 3 or 4 milliamperes. It may be that the trouble is merely due to the fact that an unnecessarily high anode voltage is being applied, in which case the remedy is obvious. Of course, a partial short-circuit between plate and filament circuits might be responsible, and you should make a test with the valve filament extinguished.

There remains the possibility that the detector valve is "soft," in which case there is nothing to do but to change it.

o o o o

Too Much Damping.

Will you please tell me if it is possible successfully to adapt the "Record III" receiver for power grid detection, using the scheme outlined in your issue of May 7th? R. P. W.

This set is designed throughout on the assumption that its tuned circuits will be lightly damped, and so it is by no means suitable for power grid detection, which would impose a considerable load on the H.F. transformer secondary circuit.

FOREIGN BROADCAST GUIDE.

ZURICH

(Switzerland).

Geographical Position: 8° 33' E. 47° 22' N.

Approximate air line from London: 475 miles.

Wavelength: 459 m. Frequency: 653 kc.

Power: 0.65 kW.

Time: *Central European (one hour in advance of G.M.T.).

* B.S.T. coincides with C.E.T.

Standard Daily Transmissions.

11.00 B.S.T. concert (Sun.); 12.30 (daily) time signal, weather; gramophone records; 16.00 concert relayed from Carlton-Elite Hotel; 20.00 main evening programme; 22.00 news; 22.10 dance music (Sats. only). Frequently relays transmissions from Vienna. Closes down with usual German formula and a short sentence in Grison dialect.

Male announcer only. Call: *Hallo, hier Radio Zurich* (phon. *Tsee-rich*). All announcements in the German language.

Interval Signal: Two notes, as under, repeated *ad lib*.

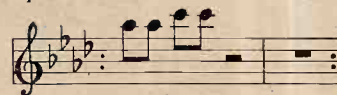

CONDENSED CHATS

By
**DOCTOR
DUCON**

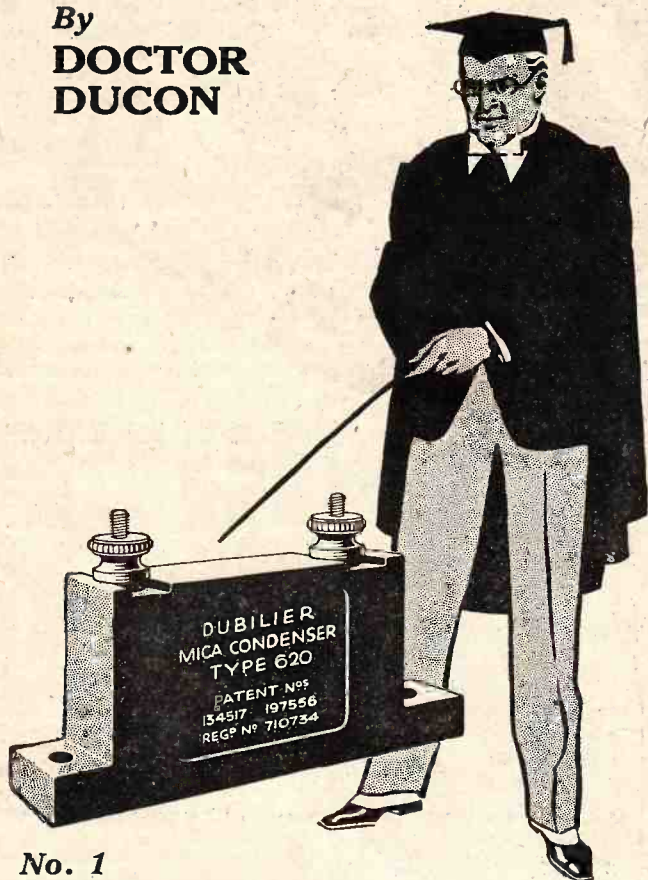

No. 1 FACTS ABOUT MICA CONDENSERS

The most important things in designing fixed Condensers are to ensure constant capacity and to provide against all sorts of climatic conditions. If these points were not provided for, totally unsatisfactory condensers would result.

Small capacity Mica Condensers such as are used in radio sets and amplifiers must have special care because the whole performance of an otherwise fine set can be completely ruined by only one faulty condenser.

Dubilier type 610 and type 620 condensers are designed and manufactured with the utmost care. They are specially clamped to avoid change of capacity and hermetically sealed to combat climatic conditions; you can therefore be certain that, with Dubilier Condensers in your set, its performance will be remarkable and you are certain never to suffer from Condenser breakdowns. Specify Dubilier for your next Set.

Types 610
and 620
'00005 to '0009
2/6
'001 to '006
3/-
'007 to '009
3/6

DUBILIER

CONDENSER CO. (1925) Ltd.
DUCON WORKS, VICTORIA ROAD, N. ACTON, LONDON, W.3

AND NOW MAINS PORTABLES The "ENEMAINS" CONVERTIBLES



The PORTABLE which works on ANY
MAINS either on A.C.
OR „ D.C.
OR „ battery and accumulator
WHICHEVER YOU WANT.

The change can be made by a child in less than two minutes (the A.C. and D.C. eliminators being interchangeable).

The Portable cabinet measures 18" x 17" x 8" and aerial, loud speaker and alternatively A.C. eliminator, D.C. eliminator or batteries and accumulator are self-contained.

PORTABLE, fitted with A.C. unit,
35 Guineas complete.
D.C. unit **30** „ „

DETAILS ON APPLICATION.

Sole Distributors:—

THE "LOUD SPEAKER" CO. LTD.
PALMER WORKS,
2, Palmer Street, WESTMINSTER, S.W.1
'PHONE:—VICTORIA 3283.

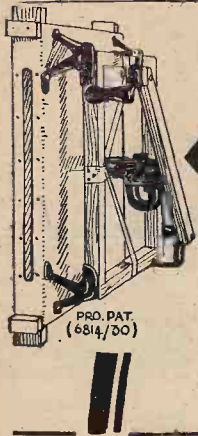

A REVELATION! BETTER THAN MOVING-COIL.
The NEW 'APTUS' DOUBLE LINEN DIAPHRAGM SPEAKER WITH THE TONE CHAMBER

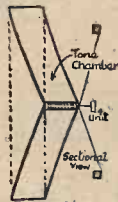

Hear it reproduce the rich bass notes without the over-emphasis of the Moving-coil Speaker. Operates from an ordinary valve set. Unlike the moving-coil speaker, it requires no extra valves, batteries, transformers or mains connections. Rich low notes. Brilliant high notes. Clarity in speech. **THE IDEAL SPEAKER FOR PORTABLE AND RADIOGRAM. DOUBLE DIAPHRAGM.** Specially manufactured linen, treated and strained by our own process. **INDIVIDUALLY TESTED ON ACTUAL BROADCAST AND PICK-UP. DRIVING UNIT.**—The finest super 4-pole balanced armature adjustable unit.

SEND FOR LISTS OF PARTS AND FITTINGS, etc.
 "The Linen Speaker Specialists."
 Over 50 Years' Reputation.

MOORE & Co., 101 & 103, Dale St., LIVERPOOL.
 Works: Gresham Buildings. Phone: Cen. 5284. Grams: "Solutions."

CHASSIS (as illustrated).
 22" x 22" .. £3 10 0. 18" x 18" .. £3 2 6
 20" x 20" .. £3 5 0. 16" x 16" .. £2 17 6
SPECIAL SIZES for Portable Sets to order.
 Without Unit, less 20/-
TABLE MODELS (Oak). Mahogany 10% ex.
 22" x 22" .. £6 0 0. 18" x 18" .. £5 0 0
 20" x 20" .. £5 15 0. 16" x 16" .. £4 15 0
ART PEDESTAL CABINETS (Oak or Mahog.)
 22" x 22" .. £10 10 0. 20" x 20" .. £9 17 6



NO IDLE CLAIMS.

Ask your Dealer to prove its **AMAZING SUPERIORITY.**

Utility

Smooth reaction at all points of the scale, one-hole fixing, fully guaranteed. The "Utility" range offers many such values as this—why not write now for fully illustrated up-to-date List of "Utility" Condensers, Switches and Dials? "Utility" Components are stocked by all good dealers.

DIFFERENTIAL CONDENSER

WILKINS & WRIGHT, Ltd.,
 "Utility" Works, Holyhead Road, BIRMINGHAM.

PRICES

- Cap. .0001 .. 6/6
- .. .00015 .. 7/-
- .. .0002 .. 7/6
- .. .0003 .. 9/6

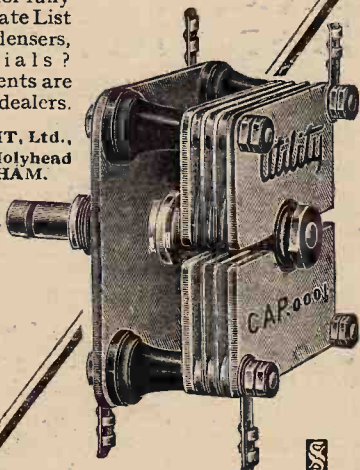

A UNIQUE

ALL IN THREE VALVE



RECEIVER

A revelation in entirely self-contained radio sets designed to operate with an inside and outside aerial at all up to 50 miles in the case of the two valve set and 100 miles with the three valve set from a main Broadcasting Station.

Fitted with the renowned Chakophone-Colossi Patent Adjustable Speaker Unit, Slow Motion condenser controls and one switch which gives the "On" and "High" and "Low" wave ranges. Price

£11/-

Two Valve Set. Price £9. 9. 0.

Brief Specification: Two Valve Receiver. Circuit—Det. and Pentode Transformer coupled. Tuning range 200 to 2,000 metres. Excide 2 volt D.F.G. Accumulator, 90 volt Eagle H.T. and 9 volt G.B. Battery. Three Valve Receiver. Circuit—Det. and two Transformer-coupled L.F. Stages. Tuning range 200 to 2,000 metres. 2 volt D.F.G. Excide Accumulator, Eagle 90 volt H.T. and 9 volt G.B. Battery.

Manufactured by **EAGLE Engineering Co., Ltd.,** Warwick.

MAGNUM SCREENING BOXES

Made of stout gauge aluminium and fitted with stained baseboard. Frosted finish. Size 6½ x 6½ x 6 ins. PRICE .. each **6/-**

Specially recommended for "New Foreign Listener's Four" and "H.F. Stage Unit."

We specialise in "New Foreign Listener's Four" as a constructional kit and also ready wired and tested.

Full particulars, including list of leading short wave stations and "Volume Controls and Dissolvers and How to Use Them," Free on request.

BURNE-JONES & CO., Ltd.,
 "MAGNUM" HOUSE, 296, Borough High Street, LONDON, S.E.1
 Telephones: HOP 6257 & 6258.



BULLPHONE A.C. and D.C. ELIMINATORS

For volume and background silence.

D.C. Model 1. Total Output 25 m.a. 120 volts. Price 27/6

D.C. Model 2. 25 m.a. 120 volts. With two variable tappings 0-130 volts. One Power fixed tapping 120-130 volts. Price 37/6

A.C. Models for all voltages between 110 and 250 volts, 40 to 100 cycles. Prices from £3 19 0 to £10 10 0

Send for our Free Lists and Circuits—

BULLPHONE LTD. (Dept.), 38, HOLYWELL LANE, LONDON, E.C.2.

Mention of "The Wireless World," when writing to advertisers, will ensure prompt attention.

MISCELLANEOUS ADVERTISEMENTS.

NOTICES.

THE CHARGE FOR ADVERTISEMENTS in these columns is:

12 words or less, 2/- and 2d. for every additional word.

Each paragraph is charged separately and name and address must be counted.

SERIES DISCOUNTS are allowed to Trade Advertisers as follows on orders for consecutive insertions, provided a contract is placed in advance, and in the absence of fresh instructions the entire "copy" is repeated from the previous issue: 13 consecutive insertions 5%; 28 consecutive, 10%; 52 consecutive, 15%.

ADVERTISEMENTS for these columns are accepted up to FIRST POST on THURSDAY MORNING (previous to date of issue) at the Head Offices of "The Wireless World," Dorset House, Tudor Street, London, E.C.4, or on WEDNESDAY MORNING at the Branch Offices, 19, Hertford Street, Coventry; Guildhall Buildings, Navigation Street, Birmingham; 260, Deansgate, Manchester; 101, St. Vincent Street, Glasgow, C.2.

Advertisements that arrive too late for a particular issue will automatically be inserted in the following issue unless accompanied by instructions to the contrary. All advertisements in this section must be strictly prepaid.

The proprietors retain the right to refuse or withdraw advertisements at their discretion.

Postal Orders and Cheques sent in payment for advertisements should be made payable to **ILIFFE & SONS Ltd.**, and crossed **Notes** being untraceable if lost in transit should not be sent as remittances.

All letters relating to advertisements should quote the number which is printed at the end of each advertisement, and the date of the issue in which it appeared.

The proprietors are not responsible for clerical or printers' errors, although every care is taken to avoid mistakes.

NUMBERED ADDRESSES.

For the convenience of private advertisers, letters may be addressed to numbers at "The Wireless World" Office. When this is desired, the sum of 6d. to defray the cost of registration and to cover postage on replies must be added to the advertisement charge, which must include the words Box 000, c/o "The Wireless World." Only the number will appear in the advertisement. All replies should be addressed No. 000, c/o "The Wireless World," Dorset House, Tudor Street, London, E.C.4. Readers who reply to Box No. advertisements are warned against sending remittance through the post except in registered envelopes; in all such cases the use of the Deposit System is recommended, and the envelope should be clearly marked "Deposit Department."

DEPOSIT SYSTEM.

Readers who hesitate to send money to unknown persons may deal in perfect safety by availing themselves of our Deposit System. If the money be deposited with "The Wireless World," both parties are advised of its receipt.

The time allowed for decision is three days, counting from receipt of goods, after which period, if buyer decides not to retain goods, they must be returned to sender. If a sale is effected, buyer instructs us to remit amount to seller, but if not, seller instructs us to return amount to depositor. Carriage is paid by the buyer, but in the event of no sale, and subject to there being no different arrangement between buyer and seller, each pays carriage one way. The seller takes the risk of loss or damage in transit, for which we take no responsibility. For all transactions up to £10, a deposit fee of 1/- is charged; on transactions over £10 and under £50, the fee is 2/6; over £50, 5/-. All deposit matters are dealt with at Dorset House, Tudor Street, London, E.C.4, and cheques and money orders should be made payable to Iliffe & Sons Limited.

SPECIAL NOTE.—Readers who reply to advertisements and receive no answer to their enquiries are requested to regard the silence as an indication that the goods advertised have already been disposed of. Advertisers often receive so many enquiries that it is quite impossible to reply to each one by post.

"WIRELESS WORLD" INFORMATION COUPON

This Coupon must accompany any Question sent in before

JUNE 18th, 1930

For Particulars of Free Service, see Rules on page 636.

B&J

ALL WIRELESS WORLD COILS, DIALS & CABINETS

Short Wave Coils, etc.

B&J. Wireless Co.

2, 3, & 4, Athelstane Mews, Stroud Green Rd., N.4.
Archway 1695.

"ALL MAINS"

suit any electric supply, A.C. or D.C.

NO AERIAL OR EARTH
H.T. BATTERIES
L.T. ACCUMULATORS
HUM-TROUBLE.



5-valve set, complete with loud speaker, will receive principal British and Foreign Stations. **£16-16-0**
long and short wave
Demonstrated in your home without charge or obligation.

Illustrated Catalogue Post Free or Call.

I.D.S. 4, Golden Sq. (Piccadilly Circus), W.1.
Telephone: Gerrard 2437.

IT "STAYS PUT"

REDUCED PRICE

3d.

IDEAL FOR PORTABLES

Even after the jolting of a bumpy ride in the dicky seat, or on the floorboards, of your car, the Belling-Lee Wander Plug retains its firm grip on the socket.

The secret lies in the special spring metal from which the prongs are made. Entire flex—copper, rubber, and braiding—individually gripped without use of tools. It's the plug for every Battery Socket, the plug that ensures good contact, and, thanks to its neatly engraved top, ease of connection. *Ask your dealer, or send to us for FREE Belling-Lee Handbook, "Radio Connections."*



BELLING-LEE

FOR EVERY RADIO CONNECTION

*Advertisement of Bellings & Lee, Ltd.,
Queensway Works, Ponders End, Middlesex.*

RECEIVERS FOR SALE.

SCOTT SESSIONS and Co., Great Britain's Radio Doctors.—Read advertisement under Miscellaneous. [0264]

HIRE a McMichael Portable Set, by day or week, from Alexander Black, Wireless Doctor and Consultant, 55, Ebury St., S.W.1. Sloane 1655. [0328]

STEREOPHONIC Couplers!—Send for new leaflet giving full particulars; the world's finest coupling device, amazing tone, many used in folkies.—N. Bonavia-Hunt, 96, Broadhurst Gardens, N.W.6. [9476]

LISSEN, Cossor, Mullard, Ostram sets, etc., and spare parts supplied; cash or easy payments; Provident and other trading checks accepted.—Acacia Stores, L.d., 229-231, Upper Tooting Rd., S.W.17. [9564]

MARCONI Straight Eight, just overhauled by makers, new valves fitted, long and short wave coils, Marconi H.T. eliminator, 240v. x 50c. and 6v. accumulator; no reasonable offer refused.—Apply H. Ellis, 22, Market Place, Burslem, Stoke-on-Trent. [9621]

MEGAVOX III, components as specification, cabinet, valves, perfect condition; £3.—12, Marlborough Crescent, W.4. [9685]

EDDYSTONE Scientific Screen Grid Short Wave Three, in mahogany cabinet, with coils covering 14 to 100 metres, recently tested by designers; £7.—Shelley, 97, Portsmouth Rd., Guildford. [9578]

RADIO Part Exchange.—Particulars of the first and largest service in existence will be forwarded upon request, to The Secretary, Appleby's, Chapel St., Marylebone, London. [0338]

4-VALVE Set, chassis, H.F., D., 2 L.F., Mullard eliminator, 200v. 50 cycles, Exide 6v. accumulator, new valves in perfect condition; £10 lot.—Watling, Kenilworth, Newburgh Rd., Acton. [9675]

McMICHAEL 8-valve Receiver, new portable; reasonable offers.—Heymanson, 65, Clanery Lane, W.C.2. [9676]

BERCLIF D.C.2 All Mains Receiver. 200 to 250 volts D.C.; price £14/10; with valves and royalties, suitable for M.C. speaker; particulars free; trade inquiries, specially invited.—Simmonds Bros., Shireland Rd., Smethwick. [8734]

RECEIVERS Constructed, modernised or converted; H.T. eliminators (new), from 48/-; stamp for particulars.—H. Burdett, B.Sc., Firth Park Crescent, Sheffield. [9622]

YOUR Old Receiver or Components Taken in Part Exchange for New; write to us before purchasing elsewhere, and obtain expert advice from wireless engineer of 25 years' professional wireless experience; send a list of components or the components themselves, and we will quote you by return post; thousands of satisfied clients.—Scientific Development Co., 57, Guildhall St., Preston. [0226]

ONE Only, specially tuned demonstration model Geophone World Wide Four, 2 screened grids, matched valves, splendid reproduction and gauge; £16.—R. Mason, Kirby Moorside, York. [9703]

METROPOLIS 1929 5-valve Portable, using modified superhet circuit (2 screened grid valves), practically new condition; cost. 30 guineas, accept 14 guineas.—C. J., 62, Scarie Rd., Wembley. [9701]

BARGAINS That Cannot be Missed.—Mullard Orgolar Senior, 2 screen grid stages, det. R.C., push-pull output, 3-valve grammo amplifier (Varley), world wide S.G. short wave three, Ormond speaker, valves, transformers, all guaranteed as new; write for bargain list, must sell.—W. E. L. Burtle, 18, Goodnestone Rd., Sittingbourne. [9695]

PHOENIX Master 3-star Kits, complete with cabinet, £2/2; ditto, with valves, £2/17/6; ditto, with H.T. and L.T. batteries and speaker, £4/5.—Phoenix, 314, High Rd., Lee, S.E.13. [9704]

ACCUMULATOR HIRE.

DON'T Buy Accumulators or Dry Batteries, join our C.A.V. low- and high-tension accumulator hire service, the largest and best in London; better and cheaper reception with no trouble; regular deliveries within 12 miles of Charing Cross; no deposit, payment on each delivery or by quarterly subscription; over 10,000 satisfied users; explanatory folder post free; phone or write to-day.—Radio Service (London), Ltd., 105, Torriano Av., N.W.5. Phone: North 0623-4-5. [8751]

CHARGERS AND ELIMINATORS.

ZAMPA H.T. Eliminator Kit, comprising rectifying unit (incorporating transformer, condensers, Westinghouse H.T.3), necessary condensers, choke, terminals, baseboard, etc., output 120 volts at 20 m.a., complete; 45/-; 7 days' approval against cash; other Zampa kits and transformers on request; amateur constructors' enquiries invited.—Mic Wireless Co., Market St., Wellingborough. [9836]

RAYMOND'S

27 & 28a, LISLE ST., LONDON, W.G.2

Come to LEICESTER SQUARE TUBE
This address is at the back of Daly's Theatre
TELEPHONE: GERRARD 2821.

**EVERY PORTABLE UNDER
REVIEW IN THIS ISSUE
CAN BE DEMONSTRATED
AT 28a, LISLE ST.**

"RAYMOND" 5-VALVE Suitcase Model with Cossor Valves. British Batteries. **£6 19 6**

"ROTHERMEL" 4-VALVE Screened Grid. Solid Hide Suitcase Model. Cossor Valves, Portrix H.T., etc. **£9 9 0**

"HALCYON" 1930 21 Model 4-Valve Screened Grid. Fully Guaranteed. **£13 13 0**

"PYE" 5-VALVE 1930 Model **£19 19 0**
H.P. Terms Twelve Monthly Payments of 35/-.

"McMICHAEL" Super Range 4-Valve Screened Grid. **£23 2 0**
Or £5 Down and Ten Monthly Payments of £2 1 0.

"AMPLION" New Two S.G. Portable. Sensational Performance. Cash **£24 15 0**
Or £3 14 3 Deposit and 12 Payments of 36/10 month.

We can supply on easy payments every well-known Portable reviewed in this issue.

Write for full details of the set that interests you.

Advertisement of K. Raymond, Ltd.

Chargers and Eliminators.—Contd.

CHEBROS—Chebros for all types of transformers and chokes, high grade instruments at a very moderate price; enquiries invited.—Chester Bros., 244, Dalston Lane, London, E.8. [5290]

PHILIPSON'S Safety High Tension Supply Units for A.C. and D.C. Mains, 200-250 volts 40-60 cycles, also 230 volts 25 cycles.

10/- Down and Small Monthly Payments Secures the Finest H.T. Supply Available.

PHILIPSON'S Safety H.T. Units are Guaranteed for 12 Months Against All Defects.

ALL Models Sold on 7 Days' Approval to Ensure Complete Satisfaction.

PHILIPSON'S Safety H.T. Units are the Cheapest to Install and the Cheapest to Run; £1/17/6 to £6.

WRITE for Our Booklet "Radio Power," which gives illustrations and full particulars.

PHILIPSON'S Safety Loud Speaker Output Filters for All Receivers, power valve, or Pentode; a remarkable output filter at a very low price; 16/6.

PHILIPSON and Co., Ltd., Radio Engineers, Astley Bridge, Bolton. Phone: 2038 Bolton. [0318]

ALWAYS Potential Dividers, 20 m.a. type, all values, with 5 variable tappings; 2/6, post free.—Below.

ALWAYS Potential Dividers, 50 m.a. type, wire wound, 5 tapping, 20,000 ohms; 4/8, post free.—Below.

IF Your Dealer Does Not Stock, send direct and ask for complete list of Always resistances.—Abingdon Wireless Supplies, Abingdon, Berks. [9478]

EKCO All Mains Unit, No. C2a, D.C. 200-250v., new; £3/10.—Cowell, 5, Cranley Rd., Ilford. [9682]

M-L Anode Converter, 12 volts input, 300 volts output, as new; offers.—H. W. Dimes, Harlow, Essex. [9683]

PHILIP'S H.T. Eliminator, No. 3003, gives about 150 volts at 30 m.a., and 3 G.B. tappings, in steps up to 40 volts each tap, A.C. input 250 volts, 40 cycles; £4.—C. O. Pattison, 548, Shields Rd., Newcastle-on-Tyne. [9684]

FOR Sale—240 volt A.C. eliminator; cost £10/10, accept offer.—Smith, 428, Finchley Rd., London, N.W.2. [9689]

SAVAGE'S Specialise in Wireless Power from the Mains; reliable apparatus at reasonable prices.

SAVAGE'S—Transformer laminations and Bakelite bobbins; intending home constructors should write for list.

SAVAGE'S—Reliable smoothing condensers, 1,500 volt D.C. test, 1 mid., 2/; 2 mid., 3/; 4 mid., 5/3; 500 volt D.C. test, 1 mid., 1/6; 2 mid., 2/3; 4 mid., 3/9.

SAVAGE'S—Super smoothing and output chokes, many types available; write for list.

SAVAGE'S—Mains transformer for Westinghouse H.T.4 unit, with additional winding, 4 volts centre tapped 3 amps, 23/-; transformers for other Westinghouse units available.

SAVAGE'S—Mains equipment for new Foreign Listeners Four, transformer N.F.L.4, 33/-; smoothing choke, C32G, 20/-; output choke C320, 20/-.

SAVAGE'S—Mains equipment for Power Pentode Two transformer, P.P.2, 33/-; output choke, L.C. 35P.G., 19/6; smoothing choke, L.C.36G, 18/-.

SAVAGE'S—Mains transformer B.T.4, 500-0-500 volts, 120 m. amps, 7½ volts 3 amps, 6 volts 3 amps, 4 volts 2 amps, 4 volts 1 amp, 4 volts 1 amp, all centre tapped, specially developed for automatic bias; 57/6.

SAVAGE'S—Mains transformers and power chokes are carefully and individually constructed from first class materials, with an exceptionally generous margin of safety.

SAVAGE'S, 146, Bishopsgate, London, E.C.2. Phone: Bishopsgate 6998. [9165]

REGENTONE Portable Model, A.C. eliminator, almost new; 55/-.—Freeth, 40, Aberfoyle Rd., Streatham Vale, S.W.16. [9527]

WESTINGHOUSE Rectifier, and transformer, 200-220v. output, 150v. 25 m.a., 30/-; also eliminator, 200v. A.C.—18, Whirlow Grove, Sheffield. [9699]

EKCO All-power Unit, D.C. C.T.A., guaranteed perfect, cost £5/17/6, sell £2/12/6; 2 D.E.L.410, 1 D.E.P.410, suitable for unit, 5/- each; change to A.C. case of sale.—Safford, 8, Geary Rd., Dollis Hill, N.W.10. Phone: Willesden 5229. [9700]



From "The Amateur Photographer."

For Every User of a Camera!

Every camera owner can get more pleasure out of photography and better results by reading "The Amateur Photographer" regularly.

The "A.P." caters for all photographers, including beginners and advanced workers, and contains Lessons for Beginners; Free Criticism of Readers' Prints; Answers to Queries; Regular Competitions and a weekly Art Supplement of particular interest to pictorial workers.

The AMATEUR PHOTOGRAPHER & CINEMATOGRAPHER

—The Journal for Everybody with a Camera—

Every Wednesday 3d.

ILIFFE & SONS LTD.,
Dorset House, Tudor Street, London, E.C.4.
W.W.37a.

CLIX

CLIX - LOX ADJUSTABLE Wander Plug. Fits any socket. 2d. each.

"SPRINGS CREW" Wander Plug. Vertical or Horizontal Insulators. 2d. each.

Prices include engraved insulators.

Write for full details of CLIX 21 VARIETIES.

2½d. **LECTRO LINX, LTD.**
254, Vauxhall Bridge Road, LONDON, S.W.1.
Prov. Pats.

M. MORRIS (Gramophones) LTD.,

Invite the Trade to send . . . for their latest . . .

Summer Sales Catalogue of PORTABLE GRAMOPHONES, RADIO RECEIVERS AND TENNIS REQUISITES.

54, City Road, LONDON, E.C.1

Mention of "The Wireless World," when writing to advertisers, will ensure prompt attention.

IN DEMAND EVERYWHERE

WRITE FOR FREE 36-PAGE BOOK-LET NOW.



Baker's Super Power Moving Coil Speaker

THE IDEAL SPEAKER FOR THE REALISTIC REPRODUCTION OF SPEECH AND MUSIC

Read what others say:

THE EXPERT COMMITTEE OF "THE GRAMOPHONE":—

"IN a well-matched combination it is the most efficient speaker we have yet tested. The reproduction with this speaker is extremely good on all kinds of music as well as on speech. It is brilliant and forceful right through the scale."

"VOX":—

"THE speaker is the most sensitive we have yet tested—it gives excellent quality and adequate volume with quite low powered sets and yet it will handle large inputs very effectively."

Obtain a Baker's on 14 days' approval. A comparative test will immediately convince you.

ALL BRITISH ★ Demonstrations Daily.

BAKER'S 'Selhurst' RADIO

Pioneer Manufacturers of Moving Coil Loud Speakers

Office: 80, Selhurst Road, S. Norwood, S.E. 25

Works and Demonstration Room: 42, Cherry Orchard Road, E. Croydon Telephone: Croydon 1618

CABINETS.

DIGBY'S Cabinets.—Table models in solid oak and mahogany; from 11/6 to 71/-.
DIGBY'S Cabinets. fitted with Radion or Resiston ebonite if required.
DIGBY'S Cabinets.—Pedestal model, with separate battery components; from 56/- to £12.
DIGBY'S Cabinets Made to Customers' Own Designs.
DIGBY'S Cabinets.—Write for new 16-page art catalogue.—F. Digby, 9, The Oval, Hackney Rd., E. 2. Phone: Bishopsgate 6458. [0128]

KAY'S Cabinets, the greatest range of pedestal cabinets in the kingdom; original creative designs at prices 50% lower than elsewhere; quotations for specials by return; delivery at short notice guaranteed.
RADIOGRAM Cabinets.—A variety of really practical and exclusive models from 60/-; illustrated lists free.
H. KAY, Wireless Cabinet Manufacturer, Mount Pleasant Rd., London, N.17. Phone: Walthamstow 1626. 8963

COILS, TRANSFORMERS, ETC.

BERCLIF Coils, the standard of excellence, for all "Wireless World" receivers; latest lists post free; trade supplied, all quantities.—Simmonds Bros., Shireland Rd., Smethwick. [8735]

TRANSFORMERS and Chokes for Battery Eliminators.—Chester Bros., 244, Dalston Lane, London, E. 8. [9706]

DYNAMOS, ETC.

DIRECT Coupled Generator, with 1/4 h.p. motor for 220v. A.C. 50 cycles, and 200v. 75 amp H.T. end, 7.5v. 3 amp L.T. end, all mounted upon bed plate with sorbo insulator; immediate sale, £8/10, cost more than double; condition new and guaranteed.—H. W., 40, Lebanon Rd., E. Croydon. [9686]

GRAMOPHONES, PICK-UPS, ETC.

NEW Collaro Motor, cost £2/12. C27 model; accept £1/15; particulars gladly.—60, Sherburn Terrace, Consett. [9644]

TRANSMITTERS.

CHEBROS. Chebros. Chebros transformers and choke of all descriptions, special transformers for transmitting and modulation; chokes a speciality; enquiries invited.—Chester Bros., 244, Dalston Lane, London, E. 8. [5240]

LOUD-SPEAKERS.

BAKER'S SELHURST RADIO 36-page Booklet. "Sound Advice is Yours for the Asking"; write now for new edition; see displayed advertisement on this page. [0231]

PERARDUA Moving Coil Reproducers.—These superlative instruments may be obtained for 15/- down, balance by 5 equal monthly payments; cash prices, 230-volt D.C. £3/3; 6-volt, £3.—R. Vevers, 4, York Rd., Maidenhead. [9551]

BROWN Q Model, beautiful tone and quality; accept first £7.—Details, 60, Sherburn Terrace, Consett. [9643]

MAGNAVOX Moving Coil R7, complete with output transformer, £3, for D.C. mains; or with B.T.H. rectifier for A.C., £5/17/6; perfect order.—49, Queenswood Court, King's Av., S.W. 4. Brixton 1737. [9691]

WILBURN and Co. for Magnavox and A.C. Equipment for Electro Dynamic Speakers.

MAGNAVOX for £3/3, carriage paid Great Britain, in manufacturer's sealed case.

MAGNAVOX D6, without speech transformer, 1923 model, 7 1/4 in. cone, new; £3/3.

MAGNAVOX D6 Incorporates Hum Neutralising Coil, limited number of these speakers available.

A.C. Equipment, suitable for these speakers, mains transformer, 14 volts .2 amperes, 18/-; metal rectifier, 7 volts 2 amperes, 22/6.

ELECTROLYTIC Condensers. 2,000 mfd., 15/-; 10-volt 2 amperes rectifiers, 26/6.

WILBURN and Co., 23, Bride Lane, Ludgate Circus, E.C. 4. Central 6994. [9693]

HAVE YOU SEEN THE LOTUS ALL ELECTRIC TRANSPORTABLE?

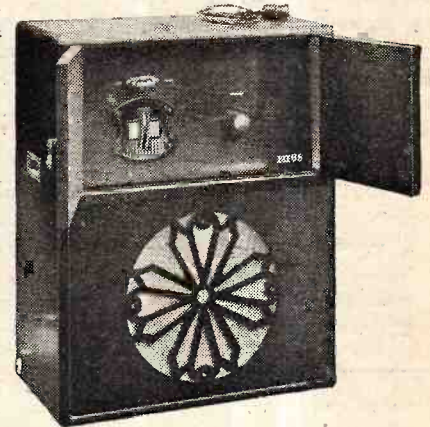

3 Valves Only yet giving 5 Valve Power

All Electric, instead of Battery operated; employing only three valves instead of the usual four or five, yet losing nothing in strength or clarity, the Lotus S.G.P. All Mains Transportable Receiver stands alone in its class.

Entirely self-contained—needs no aerial or earth wires—Loud Speaker included in cabinet—mounted on turntable for directional reception—running costs approximately 4/- per annum.

Prices: Oak Cabinet, £25. 4s. cash, or £2. 7s. down and 11 equal monthly instalments. Mahogany or Walnut Cabinet, £26. 5s. cash, or £2. 9s. down and 11 equal monthly instalments.

Write for full particulars:

LOTUS ALL ELECTRIC TRANSPORTABLE

Garnett, Whiteley & Co. Ltd.
 (Dept. "W.W." 8),
Lotus Works, Mill Lane, Liverpool.

**SPECIAL
SUMMER
OFFER**



Limited number only.

**5-VALVE
PORTABLE KIT**

including attache case

£3.10.0

Valves & Batteries Extra

**We
GUARANTEE
its
satisfactory
performance.**

An efficient, reliable and convenient self-contained receiver for home and outdoor use.

Will bring in British and numerous Foreign stations.

Wavelength range 250-550 and 1000-2000 metres.

**SCIENTIFIC SUPPLY STORES,
126, Newington Causeway, London, S.E.1.**

Phone: Hop 4177.

**CANCELLED CONTRACT.
POLISHED MAHOGANY
CABINETS.**

Height 34", Width 16 1/2"
Depth 18".

Fine Cabinet Work,
suitable for Gramo-
phone or Wireless In-
stallation, Smokers'
Cabinet, Pedestal
Cupboards, etc.

**29/6 EACH
TO CLEAR.**

Less than half actual
factory cost.



**THE AEOLIAN CO., LTD.,
131-7, NEW BOND ST., LONDON, W.1.**

POWER CHOKES

substantially built, for smoothing circuits
in eliminators dealing with currents
100 to 300 milliamperes,
inductance 30 henries,

8/6 post free

Note change of address

REPAIRS

to any make
of L.F. Transformer,
Loudspeaker or Headphones.

All repairs dispatched within
48 HOURS. TWELVE MONTHS' GUARANTEE
with each repair. 4/- Post Free. Terms to Trade.

TRANSFORMER REPAIR CO.

Dept. W.,
953, GARRATT LANE, TOOTING, LONDON, S.W.17.

Loud-Speakers.—Contd.

- E**POCH Moving Coil Speakers are Masterpieces, designed and produced by master engineers.
- E**POCH Moving Coil Speakers are the Standard by which other Speakers are Compared.
- E**POCH Moving Coil Speakers are in Use in Many Editorial Offices.
- E**POCH Moving Coil Speakers are in Use in Several Famous Laboratories.
- E**POCH Moving Coil Speakers are in Use in Many Broadcasting Stations.
- E**POCH Moving Coil Speakers are in Use by Most Prominent Musicians.
- E**POCH Moving Coil Speakers Bring Unbounded Joy to Thousands upon Thousands of Homes.
- E**POCH Moving Coil Speakers, the only speakers that give clear, uncoloured reproduction.
- E**POCH Moving Coil Speakers do Render Speech Perfectly and Music Correctly.
- E**POCH Moving Coil Speakers Provide the Perfect Illusion of the Artist's Presence.
- E**POCH Moving Coil Speakers Represent the Finest Intrinsic Value Ever Offered.
- E**POCH Moving Coil Speakers are Guaranteed for a Year, but last for ever.
- E**POCH Moving Coil Speakers Bring the Grand Concert out of the Most Modest Set.
- E**POCH.—You can hear a hundred moving coil speakers, but Epoch is different.
- E**POCH.—If you own the best set, only by Epoch can you confirm it.
- E**POCH.—Away with the tin can and cracked banjo reproduction, and install an Epoch.
- E**POCH.—Away with the drumminess, droniness and huskiness of the average moving coil speakers.
- E**POCH.—The clearest, sharpest, cleanest reproduction—a marvel of accuracy and beauty.
- E**POCH Moving Coil Speaker Models from £2/10 to £30.
- E**POCH Moving Coil Speakers.—Models for every requirement and taste.
- E**POCH Permanent Magnet Moving Coil Speakers.—Nine models from £3/15.
- E**POCH Permanent Magnet Moving Coil Speakers Require no Mains or Batteries.
- E**POCH Permanent Magnet Speakers are more Sensitive than most Energised Moving Coil Speakers.
- E**POCH Energised Models are the Finest ever put on the Market.
- E**POCH Super Cinema Speaker has Created the Biggest Sensation for Many Years.
- E**POCH Super Cinema Model is many times as Sensitive as the so-called Supers.
- E**POCH Super Cinema Speakers give Enormous Volume from a 1-watt Amplifier.
- E**POCH Super Cinema Speakers are used on many 100-watt Amplifiers and never "rattle."
- E**POCH Super Cinema Model is Standard on several Talkie Equipments.
- E**POCH Super Cinema Model is already in use in over 200 Cinemas.
- E**POCH Super Cinema are the only Moving Coil Speakers used in Large Theatres, unaided.
- E**POCH Super Cinema Speakers provide alone the Upper as well as the Lower Register.
- E**POCH.—Other Moving Coil Speakers require the help of exponential horns to provide depth.
- E**POCH.—A list of many prominent cinemas using the Speakers supplied on request.
- E**POCH Speakers are not Made of Tin or Aluminium Stampings, but are sound, solid, engineering jobs.
- E**POCH Heartily Invite Comparison, on all counts, with any make, regardless of price or claims.
- E**POCH.—Don't accept our quality claims without verification, but don't accept any other maker's either.
- E**POCH.—Order one of 7 days' approval, and test with a switch-over; the only real test.
- E**POCH Moving Coil Speakers may be heard in our Demonstration Room Daily.
- E**POCH.—Our demonstration room is in the heart of London.
- E**POCH.—Its accessibility has been studied for the convenience of callers.
- E**POCH.—If you cannot call, write for booklet W.S.3, and approval terms.
- E**POCH RADIO MANUFACTURING Co., Ltd., Farringdon Av. (near Ludgate and Holborn Circuses). Phone: Central 1971. [8983]

**"Could have been sold
over a dozen
times!"**

*A recent advertiser in
"THE WIRELESS
WORLD" writes as
follows:*

**"You may be pleased
to know that the coils
I advertised in
'THE WIRELESS
WORLD' could have
been sold over a
dozen times.**

**"They were sold first
post here on Thurs-
day morning, and I
had applications for
them for a fortnight
after."**

W. A. Pelly,
Pierhead,
Eastbourne.

W.W.g2.

**A Shoal
of Requests!**

*A recent advertiser in
"THE WIRELESS WORLD"
writes as follows:*

**"I feel I ought to
inform you how success-
ful my small advertise-
ment was in "THE
WIRELESS WORLD"
of December 25th.
Even before I had seen it
myself I had received a
shoal of requests of all
descriptions. Practically
everything was sold."**

Martin Woodroffe,
Westington,
Chipping Campden,
Gloucester.

W.W.g1.

Mention of "The Wireless World," when writing to advertisers, will ensure prompt attention.

A60

DEAF AIDS

(INEXPENSIVE)

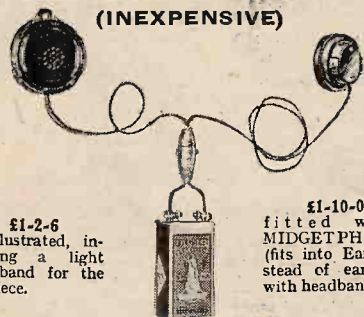

£1-2-6 as illustrated, including a light headband for the earpiece.

£1-10-0 fitted with MIDGETPHONE (fits into Ear) instead of earpiece with headband.

THIS Aid comprises the latest sensitive SUPER-MICROPHONE (to be attached to Coat or Dress, conveniently concealed), a SMALL BATTERY (for the pocket), and a SMALL EARPIECE which can be held to the deaf ear by hand or by a light headband supplied with the Aid. All speech and sound reaching the Super-Microphone is loudly heard in the earpiece. The battery can be switched off when the Aid is not in use.

Full particulars post free.

FREDK. ADOLPH, Actual Maker
27, Fitzroy St., London, W.1. Phone: Museum 8329

PILOT TRANSFORMERS



Read what "The Wireless World" said June 4th, 1930:—

"Speech was clear and crisp, and orchestral music was well balanced, the high tones as well as the bass being in evidence."

In Three Ratios: 2-1, 3½-1, and 5-1.

EACH 9/6

ENSURE PERFECT RECEPTION.

Write for catalogues of all lines manufactured by THE PILOT RADIO AND TUBE CORPORATION OF NEW YORK, to:—

THOMAS A. ROWLEY LTD.,
59 SKINNER LANE, BIRMINGHAM
Sole Agents for Great Britain and Ireland.



EVERY FRIDAY, FOURPENCE

VALVES.

AMPLIFIER Valve.—If you require power you cannot do better than one of these:—

FILAMENT Volts 6, plate volts 400 (maximum); grid bias 84 volts (approx.); impedance 800 ohms; amplification factor 3.8, mutual conductance 4.35 m.a./volts; price £5/10; see article "The Wireless World," 24th July, 1929, then send to North London Valve Co. Ltd., 22½, Cazenove Rd., Stoke Newington, London, N.16. [9657]

WIRE.

ENAMELLED, D.S.C., D.C.C., and resistance, Litz. frame aerial, fuse wires.—Frost, 54, Clerkenwell Rd., E.C.1. [9707]

COMPONENTS, ETC., FOR SALE.

BELLING-LEE Panel Fittings are designed to give an expert finish to any home constructed set; catalogue post free.—Belling and Lee, Ltd., Queensway Works, Ponders End, Middlesex. [0018]

COMPONENTS Lent on Hire.—Details from Alexander Black, Wireless Doctor, 55, Ebury St., S.W.1. Sloane 1655. [0329]

NEW Kilo-Mag Four Coils, 26/- set; Mullard permeacore transformer, 14/—Box 6276, c/o The Wireless World. [9665]

U9, M.H.L.4 valves, 10/- each, unused; McMichael Junior H.F. choke, 2/6.—115, Laycock Mansions, Laycock St., N.1. [9677]

A MATEUR'S Surplus.—Large assortment components and valves; cheap; send stamp for list.—Smart, 82, Borough Rd., Birkenhead. [9679]

RADIO HOUSE, HUDDERSFIELD, issues the Reliability Wireless Guide, which will be sent post free upon request by Messrs. J. H. Taylor and Co., 15, Macaulay St., Huddersfield. [7823]

PART Exchange.—See our advertisement under Receivers for Sale.—Scientific Development Co., 57, Guildhall St., Preston. [0228]

FERRANTI O.P.4C, 10/6; A.F.3, 14/-; Watmel Auto-choke, 7/6; J.B. reaction, 3/-; small Ormond S.M., 1/6; Dubilier H.F. choke, 2/-; Lotus 3-pole D.T., 2/6; Burdett D.P.D.T., 2/-; Lissen 25,000 and holder, 2/6; Lissen L.F. choke, 2/-; Polar fixed potentiometer, 1/-; T.C.C. fluid, 1/6 each; Sprung V.H., 6d. each; wattmeter Optic.—1, Louisville Rd., S.W.17. [9698]

SACRIFICE.—B.T.H. gramophone motor and R.K. moving coil, 200v.; £5.—Roberts, 281, Brockley Rd., S.E.4. [9702]

MISCELLANEOUS.

CALIBRATE Your Set with the C.D.E.S. Calibration Chart; 8d. post free.—C.D.E.S., 98, Cherry Orchard Rd., Croydon. [8612]

ALEXANDER BLACK.

THE Original Wireless Doctor, will call (London and Home Counties) and cure your set.

CONSULTATIONS by Appointment Without Obligation, sets installed, maintained, and brought up to date, gramophone pick-ups, eliminators, and Webson moving coil speakers demonstrated; purity reproduction specialists.

55, Ebury St., Victoria, S.W.1. Sloane 1655. [0277]

EASY Payments.—We supply, by easy payments, components, accessories, and sets, any make; 10% down, balance spread over 11 months.—Send list of requirements to London Radio Supply Co., 11, Oat Lane, London, E.C.2. [0337]

SCOTT, SESSIONS and Co., Great Britain's Radio doctors, officially approved as wireless repairers by Radio Society of Great Britain and Wireless League; old sets of every type repaired, rebuilt, modernised; send set for immediate quotation.

SCOTT, SESSIONS and Co.—New sets constructed with your or our components, guaranteed finest workmanship; we specialise in "The Wireless World" circuits; remember, we have satisfied customers throughout the British Isles and in three Continents; if you so desire, we will design and construct high grade apparatus to suit your special circumstances for quality, time and selectivity.—Tel.: Tudor 5326. Muswell Hill London, N.10. [0262]

SCINTILLATING EXCELLENCE

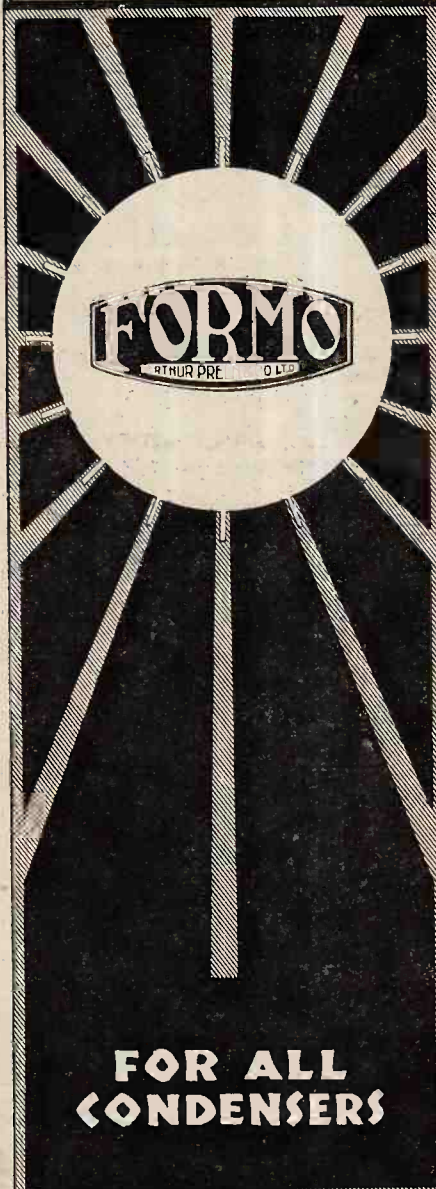

FOR ALL CONDENSERS

TYPE ILLUSTRATED CATALOGUE POST FREE.

LOG-MID-LINE
Cat. No. Caps.
C.N.5 '0005
C.N.6 '00035
C.N.7 '00025
C.N.8 '00015

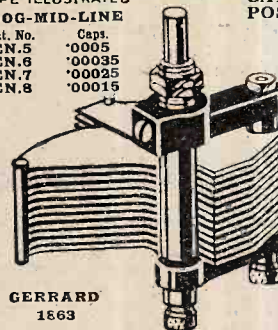

GERRARD 1663

46

GOLDEN SQUARE, PICCADILLY CIRCUS, LONDON. C.N.5.

EPOCH MOVING COIL SPEAKERS

The Greatest Success in Wireless to-day.

A New Model for Portables
(Weight 3½ lbs.)
40 Other Models
(including the famous Model 99 PM shown below).

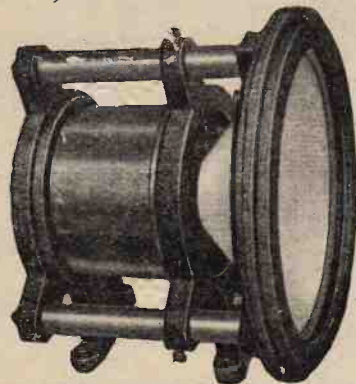

There is a sound reason for our phenomenal success!

Further increase in production now enables deliveries to be made within 7 days of order.

Call for a demonstration or send for Booklet W.S.3.

Epoch Radio Manufacturing Co. Ltd.,
Farrington Avenue, E.C.4.

Why not dance to Radio Paris, Toulouse and Hilversum Music?

With the "Supremus" All Electric 2-Valve Receiver it is the simplest matter. So simple that even a child can operate it. You should hear it. Long and short wave stations can be obtained by the mere operation of a switch. This set is equal to any 3-valve battery operated receiver. London listeners have been specially catered for and stations can be parted easily. There is a 12 months' guarantee with each set.

Using a "Supremus" All Electric 2-Valve Receiver a Birmingham amateur picked up 18 stations full speaker strength at first attempt.

"SUPREMUS" 2-VALVE ALL ELECTRIC

SUPREMUS SPECIALITIES Ltd.,
118, HIGH ST., ERDINGTON, BIRMINGHAM

Northern Agents: THE CHORLTON METAL CO., 18, Amber Street, Manchester.

London Agent: P. H. SMEDLEY, 50, Richmond Road, Leytonstone, E.11.

PATENTS.

THE Owner of British Patent No. 272887, for electrical amplifying systems, is desirous of entering into negotiations with one or more firms in Great Britain for the purpose of exploiting the above invention, either by sale of the patent rights or by the grant of a licence or licences to manufacture on royalty. —Enquiries should be addressed to Messrs. Abel and Imray, 30, Southampton Buildings, London, W.C.2. [9680]

PATENT AGENTS.

PATENTS and Trade Marks, British and foreign.—Gee and Co. (H. T. P. Gee, Member R.S.G.B. and A.M.I.R.E.), 51-52, Chancery Lane, London, W.C.2. Phone: Holborn 1525. [0001]

KING'S PATENT AGENCY, Ltd., 145a, Queen Victoria St., E.C.4.—Free advice and handbook on patenting inventions and registering trade marks by registered agent with 43 years' experience. [0002]

REPAIRS.

SCOTT SESSIONS and Co., Great Britain's radio doctors; read advertisement under Miscellaneous column. [0263]

REPAIRS Returned Post Free, and to ensure satisfaction send remittance after approval of same.—Leeds Wireless Repair Service.

LOUD-SPEAKERS, headphones, rewound to any resistance and remagnetised. 5/-; transformers rewound. 4/-; Blue Spots, Tritons and 4-pole units, 4/6; work guaranteed.—Leeds Wireless Repair Service, 5, Boston Place, Green Rd., Leeds. [9659]

GUARANTEED Repairs by Experts.—Loud-speakers, headphones, cone units, pick-ups, any type, rewound, remagnetised, and adjusted post free 4/-; transformers, from 4/-.—Howell, 91, Morley Hill, Enfield, Middlesex. [9555]

THE BARNES RADIO SERVICE.—Repairs, rebuilding, demonstrations, radio gramophones and scratch filters; reproduction specialists; any distance.—53, High St., Barnes, S.W.13. Putney 5633. [9705]

WANTED.

ALL Types of Electrical and Wireless Apparatus Purchased for Cash; large quantities only.—T. W. Thompson and Co., 17, Strutton Ground, S.W.1. [0331]

M-L Anode Converter, input 6 or 12 volts, output 200-300 volts.—Waterson, 658, Lytham Rd., Blackpool. [9687]

WANTED, Novotone, reasonable price.—Cameron, 8, Janefield Terrace, Dumfries. [9688]

WANTED, Burndept Ethovernier dials and other components, for cash or exchange.—Box 6360, c/o The Wireless World. [9694]

WANTED, 6v. S.G. valve, also super power 6v. valve. McPhee, Blackburne, Bathgate. [9697]

EXCHANGE.

WE Will Accept Your Surplus Apparatus (making you a high allowance) in Part Payment for any new apparatus; your enquiry will be dealt with promptly.—Bostock and Stonnill, 1, Westbourne Terrace, S.E.23. [9696]

SITUATIONS VACANT.

AMATEUR Constructors Wanted as Agents in A.C. Districts for Eliminator Kits, etc.—Details from Fel-Ectric Radio, 56, Garden St., Sheffield. [9258]

WIRELESS Operating; fees payable after appointment; amateur Morse classes.—Manager, Wireless School, 21, Manor Gardens, London, N.7. [9578]

WIRELESS Services.—The premier telegraph college in the British Isles (established 34 years) gives a sound training to all students, with assured positions on qualification; fees are not disguised under expensive board-residence scheme, but are payable by easy instalments, if desired.—Apply for Prospectus, Dept. "W.W." The London Telegraph Training College, Ltd., Morse House, Earl's Court, S.W.5. [9615]

FIRST Class Opportunity.—Three salesmen to call on behalf of reputable local radio trader, sell by home demonstration Nationally advertised receivers; salary and commission to men of proved selling ability; some radio knowledge essential.—Write fullest record to Box 6344, c/o The Wireless World. [9650]

MANUFACTURERS

OF METAL CABINETS, METAL CHASSIS, ELIMINATOR CASES, & SCREENING BOXES.

Experts in Wood Finishes on Metal. Crystallising and Crinkle Finishes a Speciality. All Classes of Stove Enamelling.

TRADE ENQUIRIES INVITED.

RIGBY & WOOLFENDEN,
Milnrow Rd., ROCHDALE.

Phone: 2948.

METAL CABINETS FOR ALL "WIRELESS WORLD" SETS from 27/6.

Send for Literature and Prices to:
SAMUEL EATON & SONS, 68-72, BARR ST., BIRMINGHAM.
Trade Enquiries Solicited.

BONA FIDE TRADERS' GUIDE.

Send for our comprehensive Illustrated List. QUICK SERVICE. QUICK SERVICE.

THE QUALITY HOUSE.

PERSEUS MFG. CO., LTD. (Dept. W.W.)
BRANSTONE RD., BURTON-ON-TRENT.

ALL MAINS TRANSPORTABLE

Retail Price 20 Guineas.

Applications are invited for District Agencies.

YATES, SUTTON, Ltd., York St., LEICESTER.

ELEX

WANDER PLUGS

Actual size, nickel plated, 6 colours. 2DW Standard size, 2DW or Midget, 2d. each.
Write for List X105.

I. J. EASTICK & SONS,
118 Bunhill Row, London, E.C.1

SPECIFIED for the YACHTSMAN'S SET

TWO '0005, No. 3 "POLAR"
Drum Control Condensers.

WINGROVE & ROGERS Ltd.
188-9, Strand, London, W.C.2

METAL CABINETS

for all Wireless World sets from 22/6.
Aluminium screening boxes, all sizes, to order. Standard size from stock, 6x6x6½, price 4/- each.

W. H. PARKER, Sheetmetal Workers,
Back Autumn Terrace, Leeds Tel. 52859.

Mention of "The Wireless World," when writing to advertisers, will ensure prompt attention.

"SWAMPED OUT WITH REPLIES!"

A reader's experience, after advertising in the Miscellaneous Columns of "The Wireless World."

"I was delighted with the result of my last advertisement in 'The Wireless World,' being swamped out with replies."

F. G. Hall,
3, Ashbourne Avenue,
Bridlington,
Yorkshire.

W.W.84

A reader who recently advertised components for sale in the Miscellaneous Columns of "THE WIRELESS WORLD" writes as follows:

"I disposed of everything the next day, and had to send quite a lot of money back.

"On each occasion my advertisement in 'The Wireless World' has proved very satisfactory."

A. E. Gardener,
53, Alexander Road,
Wimbledon, S.W.

W.W.90

Situations Vacant.—Contd.

LARGE Firm of Electrical Manufacturers Require Technical Assistants, fully conversant with power amplifiers and talking picture apparatus, for London area.—Write, stating age, experience, and salary required to Box 6367, *elo The Wireless World*. [9708]

BOOKS, INSTRUCTION, ETC.

FREE: Inventor's Guide on Patents.—T. A. A., 253. (W), Gray's Inn Rd., London, W.C.1 [6373]

TELEVISION.—The complete authorised book on television (Baird Experimental) transmission and receiving, is now ready; order "Television To-day and To-morrow" (Moseley and Barton Chapple), 7/6 net.—Pitman's, Parker St., Kingsway, W.C.2. [9309]

STEP by Step Wireless.—A complete course of instruction for wireless engineers; send 1/- for first 4 weeks—Clifford Pressland, A.M.I.E.E., Hampton-on-Thames. [0195]

"WIRELESS WORLD," 1921-1929 inclusive; what offers?—G.G.H.F., Whitwood, East Boldon, Durham. [368]

AUCTION SALES.

By Direction of the Senior Official Receiver in Companies Liquidation; in the Matter of K.N. Electrical Products, Ltd., in Liquidation.

5, SINGER ST., OLD ST., LONDON, E.C.2.
THE VALUABLE STOCK OF ELECTRICAL PRODUCTS,
including 600 K.N. Electric Soldering Irons, Stock of Component Parts, Wireless Sets, Large Quantity of Wireless Accessories, Valves, Loud Speakers, Accumulators, Batteries, Condensers, Resistances, Ebonite Panels, Wire, Flex, Transformers, Cabinets, Cases, etc. Office Furniture, Typewriters, Fire-resisting Safe, Store Cupboards, Shelves, Benches, Lathe, Drilling Machine and other Effects.

FRANK G. BOWEN, LTD.,

will Sell by Auction on the Premises, as above, on **TUESDAY, June 17th, 1930, at 12 o'clock.**
On view day prior and morning of Sale. Catalogues may be had of the Senior Official Receiver in Companies Liquidation, 33, Carey St., W.C.2, and of the Auctioneers, 62a, Aldersgate St., London, E.C.1.

From a recent advertiser's letter:

"I must say your paper is a good advertising agency."

C. R. PEARCE,
St. Germans,
Cornwall.

W.W.46

SUMMER CLEARANCE SALE

Wonderful unrepeatable bargains. A few are listed below.

H.T. MAINS UNITS, famous British make, 220 v. D.C. 15 m/a., 25/-; leatherette case, plug and cord. **A.C. UNITS,** 220 v. 50 cycles, 15 m/a., brand new; 45/- Super A.C. Units, Westinghouse rectifier, List 27, Sale 70/-.

FELLOWS LITTLE GIANT III in Oak Cabinet with three matched valves, 35/- List 28. Ediswan 2-valve sets, 25/6.

PORTABLE 5-v. SETS by Royal Radio, etc. Guaranteed perfect working order, wonderful range and quality, 27 5s. to clear.

LOUD SPEAKERS. Moving Coil for 220 v. D.C. Mains, £3 10s. Famous M.P.A. Cone Speakers, Oak Cabinet, 15/- Boudoir Crystal Sets, 3/-.

M.L. MOTOR GENERATORS 220 v. to 400 v. 100 m/a., £9. Brand new 2,000 dynamos, motors and alternators in stock. Kindly specify wants.

Our new list of 1,000 electrical and radio gadgets will interest you. Send 1½d. stamp.

ELECTRADIX RADIOS,
218, Upper Thames Street, London, E.C.4.
Telephone City 0191

LINE TRANSFORMERS.

100/110v. input, 200/240v. output for 40/100 Cycle Mains **36/-**

To deliver up to 60 watts.

R. & B. LINE AUTO TRANSFORMERS can be supplied to step up or down for any voltage, periodicity and output.

Send your enquiries to:—

RICH & BUNDY LTD., 13, New Road, Ponders End.
Phone: ENFIELD 0777.

EASY TERMS

We supply

Every Portable Set mentioned in this issue on the lowest terms.

All other Radio components, accessories and sets also supplied.

Let us have your enquiry and quotation will be sent by return.

Efficient and Prompt Service.

The London Radio Supply Co.
11, Oat Lane, Noble Street, E.C.2.
Phone: National 1977.

BOOKS on WIRELESS

Write for complete list to
LIFFE & SONS LTD.,
Dorset House, Tudor St., London, E.C.4.

W.W.1.

The Yachting World and Motor Boating Journal

The Leading British Yachting Journal

"THE YACHTING WORLD" deals with yachts and boats of all types and tonnages, whether on the sea or inland waters. Every aspect of yachting and motor boating is covered in an attractive and interesting manner.

Every Friday 6^d.

LIFFE & SONS Ltd., Dorset House, Tudor St., London, E.C.4



for
**PORTABLE
and
TRANSPORTABLE
CABINETS.**

Model illustrated is the Carrier.

Oak 35/-

Mahgy. 39/-

CARRINGTON MANUFACTURING CO. LTD.,
24, Hatton Garden, London, E.C.1. Tel.: Holborn 8202.
Factory: Camco Works, Sth. Croydon.

4392

INDEX TO ADVERTISEMENTS.

	PAGE		PAGE		PAGE
Adolph, Fredk.	21	Gambrell Radio, Ltd.	8	Radiogramophone Development Co.	8
Aolian Co., Ltd.	20	Garnett Whiteley & Co., Ltd.	19	Raymond, K., Ltd.	18
Apollo Gramophone Co., Ltd.	6	General Electric Co., Ltd.	1	Regent Radio Supply Co.	14
Appleby, E. Hetherington	6	Hegra		Rialton Radio	14
B. & J. Wireless Co.	17	Helzman, L.	Cover ii.	Rich & Bundy, Ltd.	23
Baker's "Selhurst" Radio	19	Hughes, F. A. & Co., Ltd.	2 & 3	Rigby & Woolenden	22
Belling & Lee, Ltd.	17	Ideas Development Syndicate, Ltd.	17	Rothermel Corporation, Ltd. (Centralab)	Cover iii.
Bowen, Frank G. & Co.	23	Impex Electrical, Ltd.		Rowland Edwards & Co., Ltd.	8
Bulgin, A. F. & Co., Ltd.	24	Jackson Bros.		Rowley, Thomas A., Ltd.	21
Bullphone, Ltd.	16	Lectro Linx, Ltd.	18	Scientific Supply Stores	20
Burne-Jones & Co., Ltd. (Magnum)	16	Loud Speaker Co., Ltd. The	15	Sheffield Magnet Co.	24
Byrton, C. F. & H.	Cover i.	London Radio Supply Co.	23	Standard Telephones & Electric Co., Ltd.	Cover iii.
Carrington Manf. Co., Ltd.	23	Lever, Eric J. (Trix), Ltd.	6	Supremus Specialities, Ltd.	22
Cole, E. K., Ltd.	5	Lock, W. & T., Ltd.		Telsen Electric Co., Ltd.	Cover i.
Donotone	6	Lyons, Claude, Ltd.		Thomas, Bertram	9
Dubilier Condenser Co. (1925), Ltd.	15	McMichael, L., Ltd.	Cover i. & 11	Transformer Repair Co.	20
Eagle Engineering Co., Ltd.	16	M.L. Magneto Synd., Ltd.	4	Ultra Electric, Ltd.	Cover i.
Bastick, J. J., & Sons	22	Moore & Co.	16	Vandervell, C. A., & Co., Ltd.	7
Eaton, Samuel, & Sons	22	Morris, M. (Gramophones), Ltd.	18	Varley (Oliver Bell Control, Ltd.)	5
Edison Bell, Ltd.	7	Mullard Wireless Service Co., Ltd.	Cover iv.	Westinghouse Brake & Saxby Signal Co., Ltd.	Cover iii.
Edison Swan Electric Co., Ltd.	10	Parker, W. H.	22	Weston Electrical Instrument Co., Ltd.	4
Electradix Radios	23	Perseus Manf. Co., Ltd.	22	Wilkins & Wright, Ltd.	16
Epoch Radio Mfg. Co., Ltd.	22	Pertrix, Ltd.	12 & 13	Wingrove & Rogers, Ltd.	22
Ever Ready Co. (G.B.), Ltd.		Phillips Radio	9	Yates, Sutton, Ltd.	22
Ferno Co.	21	P.B. Radio Co.	24		

"The Skylark"
"MULTUM IN PARVO."

"The NEW SPEAKER UNIT that will bring joy to millions—

Small—but volume not sacrificed. Marvellous Purity. For the home, and a boon to Portable Set builders. This Unit will be AVAILABLE SHORTLY.

PRICE 10'6 EACH.

Complete Speaker (Unit and Chassis), 27'6

MADE BY THE MAKERS OF THE FAMOUS "KUKOO" UNIT.

SHEFFIELD MAGNET CO., Broad Lane, SHEFFIELD.

What a Lark!

REMARKABLE PERFORMANCE—REMARKABLE PRICE.

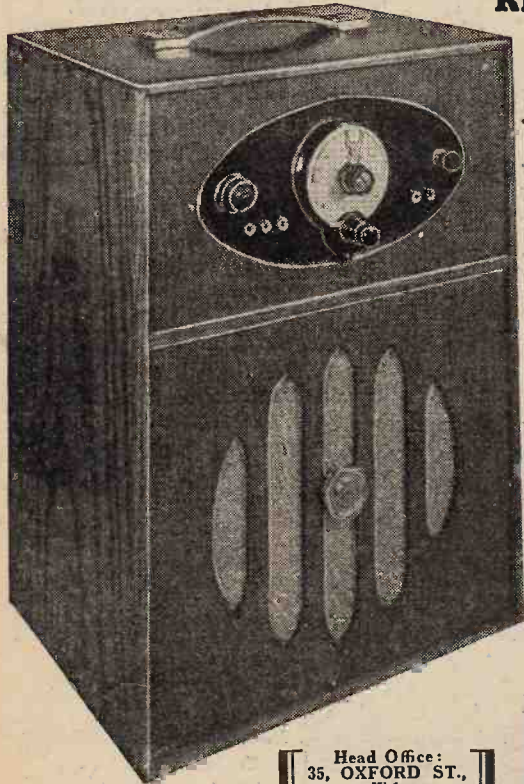

The **HARMONY THREE**

This portable, housed in handsome oak cabinet, has been specially designed to receive the Regional programmes, at full loud-speaker strength with remarkable purity of tone. Full loud-speaker strength is obtained up to a distance of 50 miles. Foreign stations are received by attaching outdoor aerial to sockets provided. By an unique device the tuning condenser can be locked at any point on the dial. There are also gramophone pick-up sockets and a safety fuse.

Set complete with frame aerial, loud-speaker, valves, battery, accumulator, etc., ready to switch on.

£7.10.0

If your dealer cannot give demonstration we will forward set, on receipt of remittance, and undertake to refund in full if not completely satisfied.

Trade Enquiries Invited.



Head Office: 35, OXFORD ST., W.1.
Works: ACTON.
Phone: Gerrard 3546.

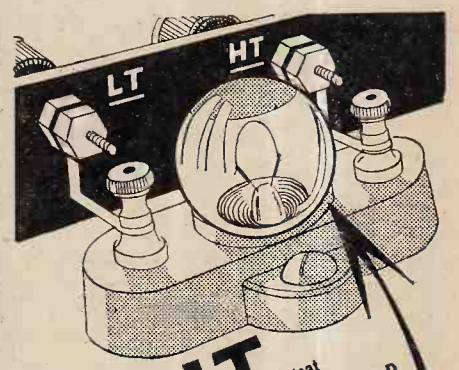

FIX IT HERE
Neat Bakelite Holders 9^D as shown
and rest assured that your valves are safe in the event of an accidental short circuit. Can be supplied in following ranges:

- .06 amp. (50 milliamps.)
- .1 " (100 ")
- .15 " (150 ")
- .2 " (200 ")

A FUSE FOR EVERY CIRCUIT

COMPETA FUSES
6 EACH

LOOK FOR THE TRADE MARK

A. F. BULGIN & Co. Ltd. 9-10-11, CURSOR STREET CHANCERY LANE, LONDON

Mention of "The Wireless World," when writing to advertisers, will ensure prompt attention.

WESTINGHOUSE RECTIFIERS

FOR HIGH TENSION BATTERY ELIMINATORS AND CHARGERS

200 volts
100 m.a.
Type H.T.1



150 volts
50 m.a.
Type H.T.4



120 volts
20 m.a.
Type H.T.3

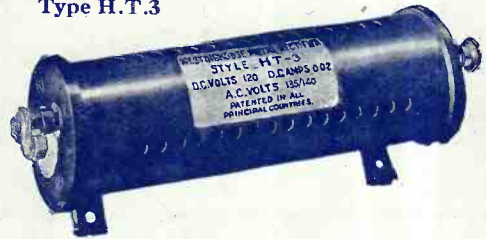

“The All-Metal Way, 1930”

32 pages of valuable eliminator information, with circuits, etc. All users of A.C. Supplies should have one.

Send your name and address and a 2d. stamp to:—

The Westinghouse Brake & Saxby Signal Co. Ltd.,
82, York Road, London, N.1.



METAL RECTIFIERS

are unquestionably the most convenient and reliable means of rectification yet devised. The circuits are simple, and the rectifiers have nothing to wear out and do not require periodical replacement. That is why they are now being used in such large numbers by the leading manufacturers.

PATENTS
STANDARD TELEPHONES AND CABLES LIMITED

Beg to announce that they are the owners of more than 60 patents relating to wireless broadcast receiving sets.

These include amongst many others:—

- Superheterodyne
- Push-pull
- Split Loop
- Hartley Oscillator
- Mains Receivers
- Free Grid Bias
- Gang Condensers
- Volume Control with Constant Impedance
- Folded Exponential Horns
- and
- (in conjunction with Electrical Research Products Inc.)
- Combined Gramophone and Radio

AND THAT they are willing to grant licences under these patents and future inventions of their own and their associated Companies to approved British manufacturers, who are invited to apply for further particulars and conditions to:—

STANDARD TELEPHONES & CABLES LTD.
Room 717, Bush House, Aldwych, W.C.2

CONTROL

is
half
the
battle!



Write for Free Booklet, "Volume Control, Voltage Control and Their Uses."

Eyes glued to the range-finder — delicate nerve of wire from the conning tower to the gun turrets . . . it's all a matter of control. Less dramatic but most important is the delicate control that holds in check the powerful amplifications of your radio valves. For smooth, efficient performance be sure the volume control on your radio is CENTRALAB.

Centralab

THE ROTHERMEL CORPORATION LTD.,
24 Maddox Street, London, W.1.

CONTINENTAL SALES OFFICE,
27, Quai du Commerce, Brussels, Belgium.

'Phone: MAYFAIR 0578/9.

Advertisements for "The Wireless World" are only accepted from firms we believe to be thoroughly reliable.

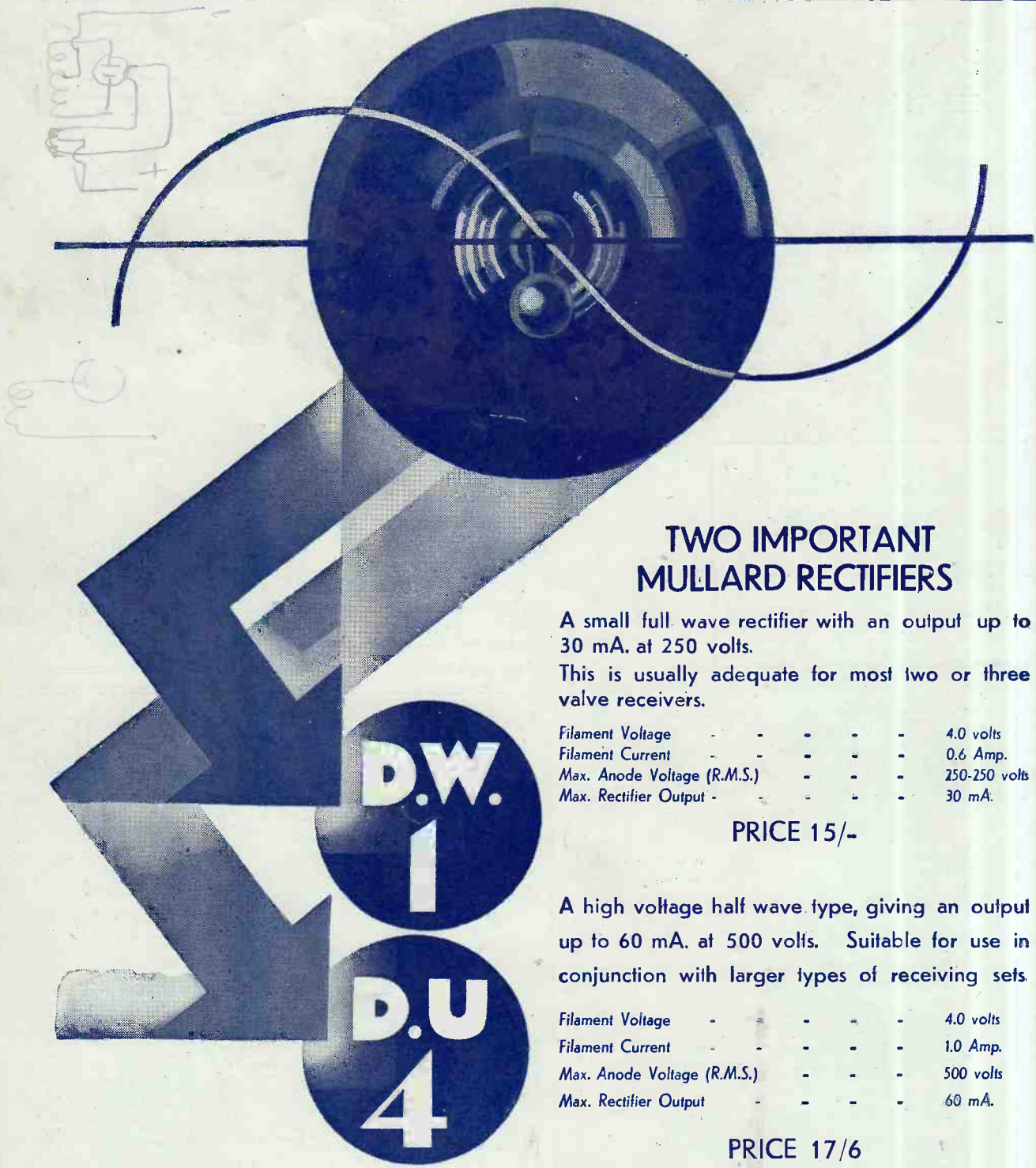

TWO IMPORTANT MULLARD RECTIFIERS

A small full wave rectifier with an output up to 30 mA. at 250 volts.

This is usually adequate for most two or three valve receivers.

Filament Voltage	-	-	-	-	4.0 volts
Filament Current	-	-	-	-	0.6 Amp.
Max. Anode Voltage (R.M.S.)	-	-	-	-	250-250 volts
Max. Rectifier Output	-	-	-	-	30 mA.

PRICE 15/-

A high voltage half wave type, giving an output up to 60 mA. at 500 volts. Suitable for use in conjunction with larger types of receiving sets.

Filament Voltage	-	-	-	-	4.0 volts
Filament Current	-	-	-	-	1.0 Amp.
Max. Anode Voltage (R.M.S.)	-	-	-	-	500 volts
Max. Rectifier Output	-	-	-	-	60 mA.

PRICE 17/6

Mullard Master Rectifier Valves for A.C. Sets and H.T. Units

Advt. The Mullard Wireless Service Co. Ltd., Mullard House, Charing Cross Road, London, W.C.2. APR.

Printed for the Publishers, LIFFE & SONS LTD., Dorset House, Tudor Street, London, E.C.4, by The Cornwall Press Ltd., Paris Garden, Stamford Street, London, S.E.1.

Colonial and Foreign Agents:
 UNITED STATES—The International News Co., 131, Varick Street, New York. FRANCE—W. H. Smith & Son, 248, Rue Rivoli, Paris; Hachette et Cie, Rue Réaumur, Paris.
 BELGIUM—W. H. Smith & Son, 78, Marche aux Herbes, Brussels. INDIA—A. H. Wheeler & Co., Bombay, Allahabad and Calcutta. SOUTH AFRICA—Central News Agency, Ltd.
 AUSTRALIA—Gordon & Gotch, Ltd., Melbourne (Victoria), Sydney (N.E.W.), Brisbane (Queensland), Adelaide (S.A.), Perth (W.A.), and Launceston (Tasmania).
 CANADA—The American News Co., Ltd., Toronto, Winnipeg, Vancouver, Montreal, Ottawa, St. John, Halifax, Hamilton; Gordon & Gotch, Ltd., Toronto; Imperial News Co., Toronto, Montreal, Winnipeg, Vancouver, Victoria. NEW ZEALAND—Gordon & Gotch, Ltd., Wellington, Auckland, Christchurch and Dunedin.

DUAL UNIT LOUD SPEAKER.

The Wireless World

AND RADIO REVIEW

4^D

The Paper for Every Wireless Amateur

Wednesday, June 18th, 1930.



**FIRST-
BECAUSE OF
THE FILAMENT**

Mullard
THE MASTER VALVE

No Batteries
No Accumulators
Plug-in - That's all!

Write for Free Booklet
on "All-Electric Radio"
and details of Easy Pay
ments to E. K. Cole Ltd.
Dept. W, 'Ekco' Works
Leigh-on-Sea

EKCO

EKCO-ELECTRIC RADIO RECEIVERS

**Utility DIFFERENTIAL
CONDENSER**



Stocked by all good dealers and the best value in a Condenser of this type that you can possibly obtain. The capacity is .0001 mfd. and the design provides smooth reaction at all points of the scale. Fully guaranteed for efficiency and finish by "Utility" - makers of the Dials, Condensers and Switches that experienced constructors always choose. Illustrated list free for a p.c.

Other Prices:

'00015	7/-
'0002	7/6
'0003	9/6

WILKINS & WRIGHT LTD.,
"Utility" Works,
Holyhead Road, BIRMINGHAM.

6'6

ACCURACY

Licensed under design Reg. No. 723271.



T.C.C.
CONDENSER
2 MF
PAT. 13345/25

T.C.C. CONDENSERS

Advt. of Telegraph Condenser Co., Ltd., Wales Farm Road, W.S. 4960

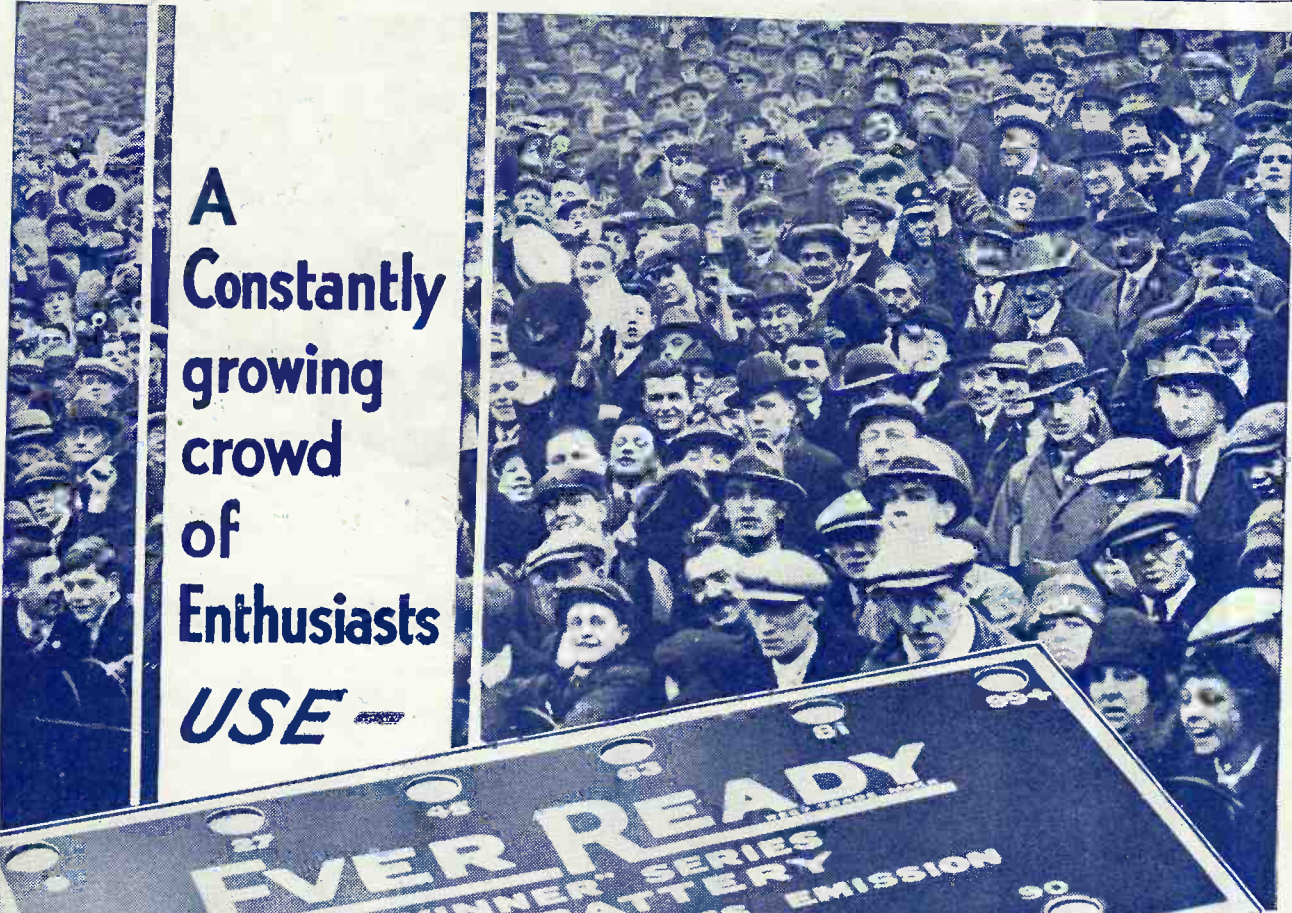

A
Constantly
growing
crowd
of
Enthusiasts
USE



EVER READY
REGD. TRADE MARK
BRITAIN'S BEST BATTERIES

"WINNER" SERIES
REDUCED PRICES

60 VOLTS 7' 6'6

66 VOLTS 7' 6 7'

99 VOLTS 11' 6 10'9

120 VOLTS 14' 13'

DARK BLUE CONTAINERS

FOR YOUR SET AND PORTABLE LAMP

Mention of "The Wireless World," when writing to advertisers, will ensure prompt attention.

TESTS OF TIME

Big Ben stands for...

...reliability and accuracy all the world over. It is a standard by which time itself is judged.

T.C.C. too, is a standard—a standard by which other condensers are judged—a standard of accuracy, reliability and dependability. The letters T.C.C. are an assurance of good service—recommended by experimenters, scientists and amateurs alike—the famous “condenser in the green case.” So, remember this, when next you ask for a condenser.

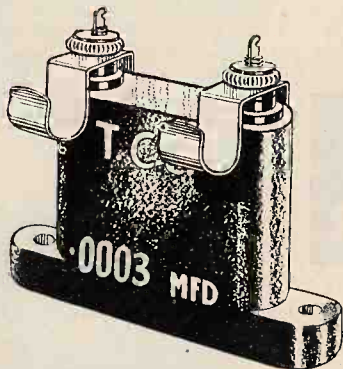

Illustrated above is a .0003 mfd. T.C.C. Upright Type Mica Condenser. Price 1/6 each. Other capacities in this type are made from .0001 mfd. to .25 mfd. Prices 1/6 to 18/-.

BIG BEN

ADVERT. OF THE TELEGRAPH CONDENSER Co. Ltd-N. ACTON, W.3



Advertisements for "The Wireless World" are only accepted from firms we believe to be thoroughly reliable.

Send your Goods by Air

The quickest and most dependable way of transporting goods between England and the Continent is by

IMPERIAL AIRWAYS

THE ONLY BRITISH AIR LINE

It means fewer breakages, because there is less handling. Lower insurance rates for all classes of goods. Quicker customs clearance.

CELESTION KNOW!

Up to last February, Imperial Airways transported approximately 51½ tons of Celestion Loud Speakers across the Channel without damage or loss. The value of these goods was £67,755. Not one of the articles was insured, nor in any case was any packing employed except the ordinary cardboard carton in which the speakers are sold. Messrs. Celestion say that the saving in insurance and packing charges more than compensates for the slightly higher charge for air transport.

In London, goods are collected on telephonic request, or may be handed in to any Freight Agent or to Airways House, Charles Street, Haymarket, S.W.1

Full particulars from any Freight Agent or direct from

IMPERIAL AIRWAYS LTD.

Airways House, Charles St., London, S.W.1

Telephone: Regent 7861 (Night & Day)

Telegrams: Impairlin, London



C.F.H. 36

A Perfect Combination !

The LEWCOS H.F. CHOKE and L.F. TRANSFORMER PROVIDE PERFECT RECEPTION.

LEWCOS L.F. TRANSFORMER.—Treble notes respond admirably, while the bass notes are reproduced with an effect more nearly approaching the true musical tones than is possible with the majority of makes. A feature of the L.F. Transformer is the provision of a Centre-Tapping on the secondary winding which renders it adaptable for push-pull amplification. Scientific research, finest materials and sound workmanship make the L.F. Transformer a worthy addition to the Lewcos range.

LEWCOS H.F. CHOKE.—Tested values of the Lewcos H.F. Choke: Self-capacity—1.62 micro-microfarads (N.P.L. test). Natural Wavelength—5,200 metres (tested with Moullin voltmeter). These figures give assurance that there will be a minimum amount of H.F. Leakage through self-capacity, while the position of the terminals, one at the top of the coil and the other at the base, is arranged so as to eliminate the risk of additional self-capacity in the wiring of the receiver.

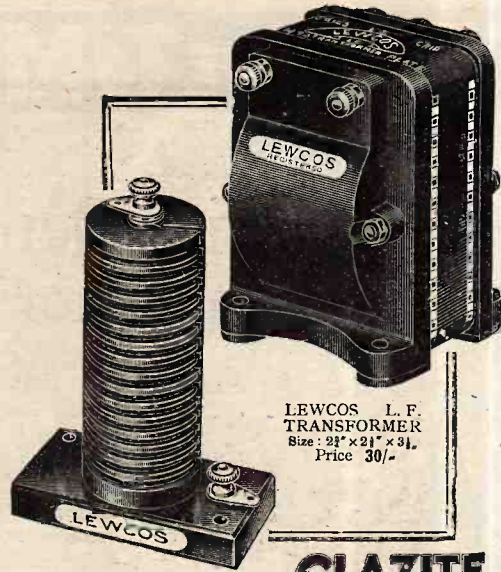

LEWCOS L.F. TRANSFORMER
Size: 2 1/2" x 2 1/2" x 3 1/2".
Price 30/-

LEWCOS H.F. CHOKE
20-2000 metres.
Price 7/9

GLAZITE
BRITISH MADE REGD

Coloured Connecting Wire
in 10 ft. coils.
Price 6d. per coil.



THE LONDON ELECTRIC WIRE COMPANY AND SMITHS LTD.,
Church Road, Leyton, London, E.10.

Stocks held at the following Branches: Belfast, Dublin, Leeds, Cardiff, Glasgow, Liverpool, Manchester, Newcastle, London.

D.C. to A.C.

If your supply mains are D.C. you can operate an A.C. All-Electric Receiver by using the

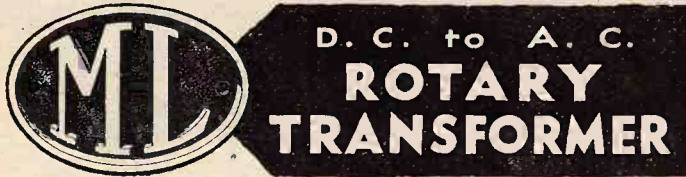

Can be supplied to run from any voltage 12-250 V.D.C. 40 watt model £13; 85 watt model £19. Recommended and used by Philips Radio, Marconiphone, Burndept, Kolster-Brandes, M.P.A., Etc., Etc.

Write for Pamphlet 596/1 which gives full details

THE M-L MAGNETO SYND. LTD.,
Radio Dept., COVENTRY.

Telephone: 5001.

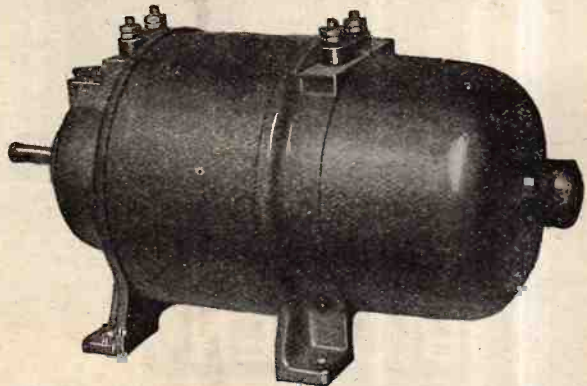

Mention of "The Wireless World," when writing to advertisers, will ensure prompt attention..

A cell taken from a Pertrix battery.



A cell taken from a Sal-ammoniac battery.

Why you get ALL the power

This photograph shows a zinc cell taken from a 120 volt Pertrix battery after it had been used for 8 months. Compare it with the small photograph of a cell taken from another battery after only 5 months' use. You see thick white corrosion on the second cell—that is why other batteries become choked long before their useful life is over. In the Pertrix battery there is

NO SAL-AMMONIAC

to corrode the zinc. You are thus able to use *all* the power from a Pertrix. It never becomes choked by corrosion nor deteriorates when not in use. Buy a *Pertrix*—the battery with the longer life. You can then tell your friends just how much longer a Pertrix battery will last. You can also obtain Pertrix batteries for your flash lamp. Write for leaflet "B," which will give you full particulars of all types.

PRICES.

Standard.	(DISCHARGE 12 MILLIAMPS)		GRID BIAS.	
	Size in inches.	s. d.		s. d.
60 volt	5 ⁵ / ₁₆ × 6 ¹ / ₈ × 3 ¹ / ₁₆	8 0	9 volt.....	1 6
100 volt	8 ⁷ / ₈ × 6 ¹ / ₈ × 3 ¹ / ₁₆	13 0	12 volt.....	2 3
120 volt	10 ³ / ₈ × 6 ¹ / ₈ × 3 ¹ / ₁₆	15 6	15 volt.....	2 9

PERTRIX

PATENT
DRY BATTERY



WHAT A LIFE!

PERTRIX LTD., Britannia House, 233, Shaftesbury Avenue, London, W.C.2. **EXIT SAL-AMMONIAC** M.C. 114

Advertisements for "The Wireless World" are only accepted from firms we believe to be thoroughly reliable.

THE RADIO EYE!

the dream of this
wonder age now
a solid fact...

NOW you can see by Wireless—the new Baird "Televisor" Home Reception Set brings Television home to you. No longer need you be satisfied with just the voices of the entertainers—you can witness all their movements. The Baird "Televisor" Home Reception Set will bring you this wonderful advantage of actual reproduction from living objects and not just built up "still" pictures. The Baird instrument will give you permanent satisfaction by its simplicity of operation and its high efficiency.

Daily broadcasts of both sound and vision from the National and Regional Stations at Brookmans Park have been a feature since March 31st. For the Home Constructors and Experimenters the Baird Television Company offer expert service and a specially made set of parts bearing the Baird Brand

BAIRD TELEVISION for the home



name. Prices for the complete Receiver and "Televisor," "Televisor" only, and kit of Baird Branded Parts will be sent on application to:

BAIRD TELEVISION Ltd.,
113, Long Acre, London,
W.C. 2
"TELEVISOR"
(Regd. Trade Mark)

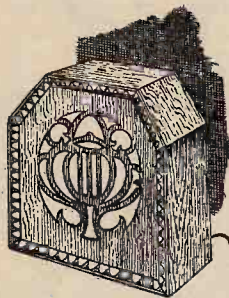

Everybody's
calling for

*Player's
Please*



WHY

PAY A HIGH PRICE
FOR YOUR **H.T.?**

Equip your set with an efficient eliminator the size of an H.T. battery and work it from the mains.
Ekco portable model IV20. For D.C. mains £2-10-0
For A.C. mains £4-12-6
Combined H.T. unit and L.T. charger.
For A.C. mains £6-0-0
New Regentone portable combined model.
Size 9" x 5" x 3 1/2". H.T. output 120 v. at 15 m/a.
H.T. Tappings 2 continuously variable and 1 power.
(One variable is specially compensated for screened grid or anode bend operated valves.)
L.T. output. Trickle charger for 2, 4 or 6 volt acctr.
For A.C. mains £5-17-6

FULL DETAILS ON REQUEST

For the Best in Radio

WILL DAY LTD.

(THE BEST IN THE WEST)
19 LISLE STREET, LEICESTER SQUARE, LONDON, W.C. 2.
Telephone: (2 Lines) Regent 0921 and 0922 Telegrams: Willday, London

Mention of "The Wireless World," when writing to advertisers, will ensure prompt attention.

The Wireless World

AND
RADIO REVIEW
(18th Year of Publication)

No. 564.

WEDNESDAY, JUNE 18TH, 1930.

VOL. XXVI. No. 25.

Editor: HUGH S. POCOCK.
Assistant Editor: F. H. HAYNES.
Editorial Offices: 116-117, FLEET STREET, LONDON, E.C.4
Editorial Telephone: City 9472. (5 lines).
Advertising and Publishing Offices:
DORSET HOUSE, TUDOR STREET, LONDON, E.C.4.
Telephone: City 2847 (13 lines). Telegrams: "Ethaworld, Fleet, London."
COVENTRY: Hertford Street.
Telegrams: "Cyclist, Coventry." Telephone: 5210 Coventry.
BIRMINGHAM: Guildhall Buildings, Navigation Street.
Telegrams: "Autopress, Birmingham." Telephone: 2970 and 2971 Milland.
MANCHESTER: 260, Deansgate.
Telegrams: "Jiffie, Manchester." Telephone: 8070 City (4 lines).
GLASGOW: 101, St. Vincent Street, C.2.
Telegrams: "Jiffie, Glasgow." Telephone: Central 4837.

PUBLISHED WEEKLY.
Subscription Rates: Home, £1 1s. 8d.; Canada, £1 1s. 8d.;
other countries abroad, £1 3s. 10d. per annum.
Entered as Second Class Matter at New York, N.Y.
As many of the circuits and apparatus described in these pages are covered by
patents, readers are advised, before making use of them, to satisfy themselves
that they would not be infringing patents.

CONTENTS OF THIS ISSUE.

	PAGE
EDITORIAL	337
DUAL UNIT LOUD SPEAKER	338
THE BAND PASS FILTER FOR LONG WAVES. BY W. T. COCKING	642
CURRENT TOPICS	648
BROADCAST RECEIVERS REVIEWED. BURDEPT UNIVERSAL SCREENED	619
FIVE	652
PRACTICAL HINTS AND TIPS	652
WIRELESS THEORY SIMPLIFIED, PART XXXIII. BY S. O. PEARSON	654
BROADCAST BREVITIES	657
READERS' PROBLEMS	658

matter of time before the British stations will also commence to sandwich advertising and propaganda matter amongst the programme material. We are told that other countries are being forced to adopt this course because the big advertisers are not prepared to stand by and see what they consider to be an effective weapon of advertising denied to them. But of what use is such a medium if its employment causes irritation and disgust amongst the listeners whom it is intended to influence? Just as the British public resents the disfigurement of scenery with advertisement hoardings, so in just the same way would the introduction of advertising amongst the entertainment of the programmes meet with disfavour. It is financial considerations alone which have been responsible for introducing advertisement matter into many of the programmes abroad, the position being that without some method of collecting revenue on the lines of the British wireless licence, stations have been unable to meet the cost of maintaining efficient programmes; but, thanks again to the organisation of our own broadcasting as initiated in the first instance, provision has been made to meet the running costs. Moreover, when, in due course, all stations are capable of being linked together more efficiently than at present, the number of individual programmes will be reduced, and, consequently, the actual programme cost; or, alternatively, the same expenditure will go towards the production of better programmes.

o o o o

BROADCAST PROPAGANDA.

THE more we have the opportunity of observing the tendency to utilise broadcasting for propaganda and for advertising purposes in other countries, the more thankful we must feel that broadcasting in our own country has been established on different lines, and that those who originally laid its foundations were so far-seeing as to make suitable regulations to ensure that our own service would not degenerate into an instrument for propaganda and publicity purposes. We frequently are tempted to express disappointment over some aspects of the programme matter put out from the British stations, yet we cannot but count ourselves fortunate by comparison with some of our neighbours on the Continent, who, unless they are prepared to listen to insidious advertising or propaganda matter at almost every interval in the transmission, are compelled to be continually on the watch to switch off and on again at the conclusion and start of every legitimate item of the programme.

It has recently been suggested to us that it is only a

RADIO SERVICING.

THE subject of training the service man, which we raised in our issue of May 14th, has provoked considerable interest and comment, and it is apparent that both the manufacturers and users are in agreement with us as to the importance of this branch of the broadcasting industry. It is, of course, realised that a service man capable of dealing with faults and repairs in any type of wireless receiver now in use would have to be a thoroughly well-trained radio engineer, because of the diversity of types of sets and circuits, but it should not be difficult to go a long way towards meeting the difficulty if those who trained for radio service, after attaining a general knowledge of their subject, specialised in a limited number of sets of well-distributed types.

If some central training organisation were established under the control of the Radio Manufacturers' Association, as we have already suggested, all standard types of receivers could be available on which those receiving instruction would be trained.

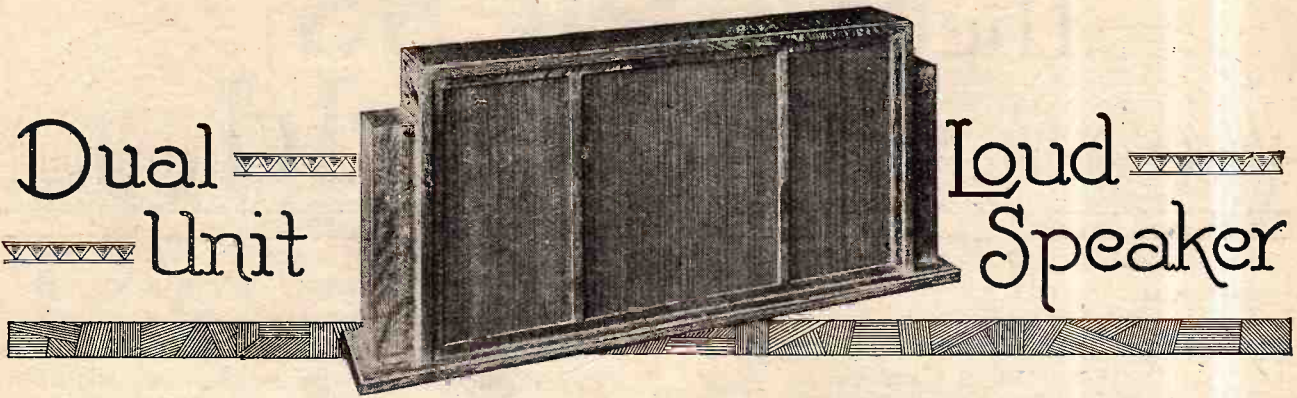
Dual
UnitLoud
Speaker

Combining Two Cone Loud Speakers to Cover all Frequencies from 50 to 6,000 Cycles.

THE problem which gave rise to these notes is one which is fairly common, and its solution should, therefore, be of general interest. Having built a simple quality receiver for use on the A.C. supply available, the writer's next problem was to find a loud speaker which would do justice to the quality of reproduction achieved at a price which would not be disproportionately high in relation to the cost of building the set.

The latter stipulation at once ruled out a moving coil and rectifier, which was naturally the first proposition to receive consideration, and it was decided to build a cone loud speaker on the strength of the information in relation to cone units given in the February 5th, February 12th, and February 26th issues of this journal. While several individual units showed promise of covering all useful frequencies, each was open to some minor objection from the writer's point of view, either on the score of unsuitable impedance or a resonance at some point in the frequency scale. In working through the figures, however, several units were noted as giving almost perfect reproduction over a band of frequencies, and it was finally decided to attempt to combine two of these units in order to cover frequencies from 50 to 6,000 cycles. The idea of combining two loud speakers in this way is by no means new, but it would appear that attempts to put this very excellent principle into practice do not always achieve the success which they merit. The special case about to be considered brought to light several pitfalls of a general character, and the means taken to avoid them can be applied with equal success to other combinations of units.

Before dealing with the problems of combination we will first review the characteristics of the individual units chosen and the reasons for their choice.

A Mullard "Pure Music" cone unit was given the task of looking after the upper register on account of

the brilliance of reproduction, under certain conditions, from 400 to 6,000 cycles. This unit has three alternative impedance tapplings, and for the present purpose the low-impedance tapping is used. Assuming a valve resistance of the order of 2,500 ohms, it will be found that, while the high-frequency response is in no way affected, there is a distinct drop in the acoustic output from 400 cycles downwards with practically no response below 150 cycles. This condition exactly suits our present requirements, as, without resorting to any additional filtering device, it avoids duplication of the low-frequency output from the companion loud speaker unit. It should be distinctly understood that this special output characteristic is obtained by deliberately using an impedance tapping which would be normally too low for the A.C. resistance of the output valve; the reproduction of the bass could be easily increased, if desired, by using the "medium" or "high" impedance tapplings

with the 2,500-ohm valve specified. The "low" impedance tapping, however, leaves the field clear to the other unit below 400 cycles. The unit chosen to fill this gap was an Ediswan, first, on account of its extraordinarily high output from 400 down to 50 cycles, and, secondly, because it is one of the few moving iron units which do not produce harmonics (frequency doubling) below 100 cycles. Above 400 cycles the general level of out-

put is less, but there is a definite response up to 4,000 cycles, and it will be seen later that means are adopted to cut off the output above 400 cycles to prevent overlapping with the Mullard unit.

In these two units, therefore, we have all the material for producing a well-balanced output from 50 to 6,000 cycles. The problem of combining them in such a way as to retain in each the desired band of frequencies is entirely one of impedance matching. Owing to the wide difference in average impedance between the two units (the Ediswan unit has about six times the imped-

It was interestingly revealed in the cone unit tests published in our issues of February 5th, 12th and 26th that, while many specimens provided excellent results over a certain band of frequencies, no instrument gave a faithful rendering over the whole spectrum. To combine two such instruments seems a simple way of obtaining a uniform response throughout, but unless the problem receives scientific treatment, the speakers may prove to be antagonists rather than friends. The author here describes how a perfect union can be achieved by the careful combination of capacity and resistance.

Dual Unit Loud Speaker.—

ance of the Mullard "low" impedance tapping), straightforward series or parallel connections are out of the question. For instance, if the units are connected in parallel, the Mullard unit, having the lower impedance, will take the greater part of the output, and there will not be sufficient current in the Ediswan to give sufficient volume in the bass. If the units are connected in series, the conditions are reversed; the high impedance of the Ediswan unit at high frequencies steals the greater part of the output voltage, and the general level is low-pitched. In fact, with the simple series connection the Mullard unit can be short-circuited without appreciably affecting the general result.

Modified Series Connections.

Nevertheless, the series method of connection shows most promise, and can be made to respond to careful treatment. We have already seen that it is the high impedance of the Ediswan unit in the upper register which brings about the failure of the simple series arrangement. But we can afford to throw away the high-frequency response in this unit, as it has already

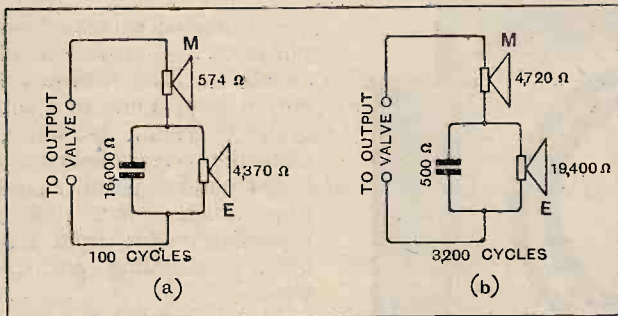

Fig. 1.—Loud speaker and by-pass condenser impedances at representative low and high frequencies.

been decided to leave the responsibility for this part of the frequency spectrum to the Mullard unit. This permits the use of a by-pass condenser in parallel with the Ediswan unit, for, if a suitable value is chosen, it will by-pass all the high frequencies to the Mullard unit without affecting the reproduction of the bass by the Ediswan unit. At the same time the redundant high-frequency response in the Ediswan unit will be suppressed.

To illustrate this point, let us consider a concrete case, and assign to the by-pass condenser a value of 0.1 mfd. In Fig. 1 the impedance values of each element of the circuit have been worked out for representative high and low frequencies. In Fig. 1 (a)

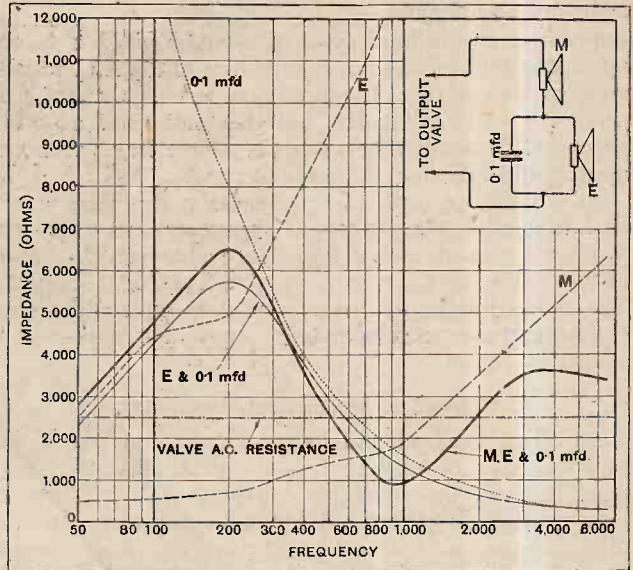
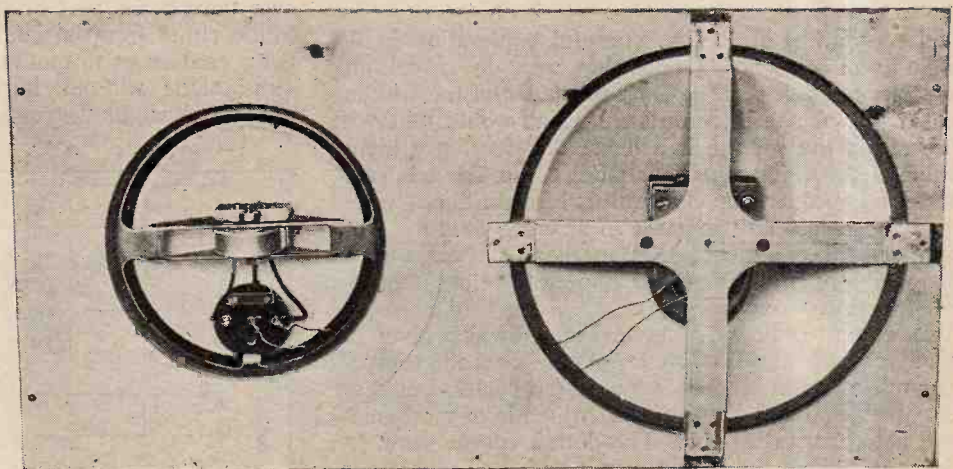

Fig. 2.—Impedance-frequency curves for various combinations of the units shown in Fig. 1. M and E represent the Mullard and Ediswan units respectively.

(100 cycles) it will be seen that the shunting effect of the condenser is small. The impedance of the Mullard unit is also low compared with that of the Ediswan, and the latter unit, therefore, receives the greater part of the available power. In Fig. 1 (b) (3,200 cycles) the Ediswan unit is virtually short-circuited by the condenser, and practically the whole of the energy is expended in the Mullard unit.

Impedance Measurements.

Fig. 2 shows the results of actual impedance measurements on the various elements of this combination. It will be seen that the combined curve of all three elements connected as in Fig. 1 is somewhat erratic, and this raises an important consideration which must be taken into account. In order to extract the maximum power available from the output valve, the



Front view of baffle showing method of mounting Ediswan unit; the wooden cross is cut from the disc removed from the baffle and fixed by metal plates at the end of each arm.

Dual Unit Loud Speaker.—

impedance of the loud speaker must be given a value approximately equal to or double that of the A.C. resistance of the valve. The optimum value is about 1.6 times the valve resistance, but the impedance may be permitted to wander between the above limits without appreciably affecting the audible result.

As a result of further experiments it was discovered that a combination of shunt resistance and capacity produced a much better impedance characteristic, and at the same time gave the required acoustic output. The values finally arrived at were 0.05 mfd. and 5,000 ohms, and the corresponding impedance curves are shown in Fig. 3.

Electrical v. Mechanical Resonance.

An effect which should be recognised, but which, in practice, may be neglected, is the possibility of resonance between the inductive winding of the Ediswan loud speaker and the shunt by-pass condenser. In the final arrangement with 0.05 mfd., this resonance occurs at 400 cycles, and is reflected in one of the curves (E

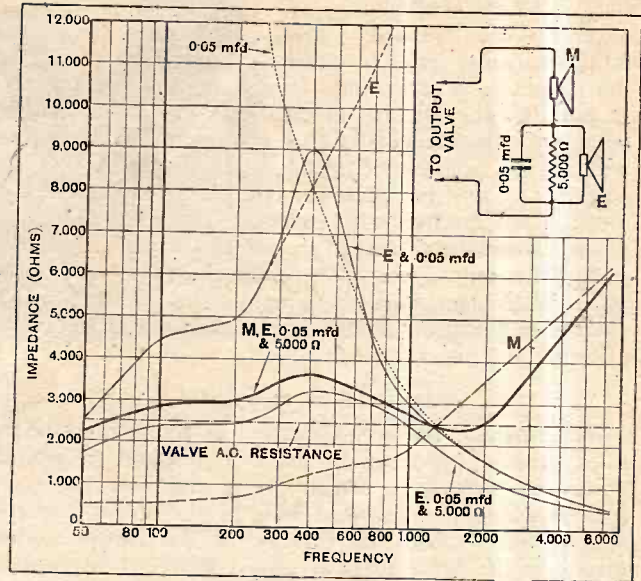
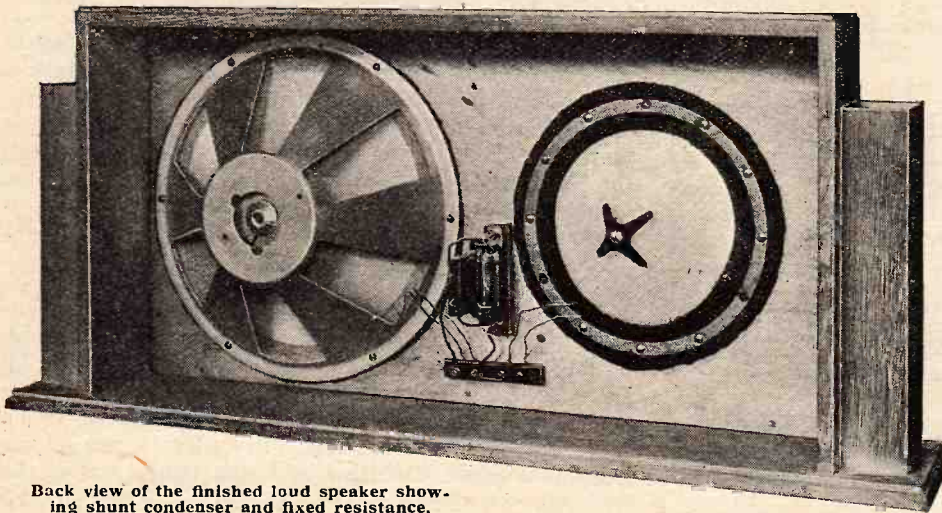

Fig. 3.—Impedance curves of the circuit finally adopted.



Back view of the finished loud speaker showing shunt condenser and fixed resistance.

and 0.05 mfd.) in Fig. 3. Careful exploration in the vicinity of 400 cycles fails, however, to reveal any acoustic resonance. The D.C. resistance of the winding limits the change in impedance which would otherwise occur, but even if the impedance did develop a higher value at this point, the poor relationship between valve and loud speaker impedance thus brought about would tend to correct any increase in acoustic output. It is a matter of experience that mechanical resonance in the armature is of far greater importance than electrical resonance in the winding.

This point is brought out in Fig. 4, which gives the results of an aural estimate of the acoustic output. There is no trace of resonance at 400 cycles, but there is a distinct dip at 1,750 cycles, which is of mechanical and not electrical origin. The dotted curves show (A) the output from the Ediswan unit with its by-pass condenser and resistance, and (B) the Mullard unit using the "low" impedance terminals. Curve C represents

the combined acoustic output from the complete loud speaker. The increased output from 2,000 to 5,000 cycles gives brilliance, while the increase below 200 cycles ensures a full round tone, which is, incidentally, remarkably free from frequency doubling in the bass.

The transfer of energy from one loud speaker to the other takes place between 350 and 400 cycles, the acoustic output from each unit being equal at about 380 cycles. The fact that

over the greater part of the frequency scale the sound comes either from one unit or the other, and not from both, enables us to mount the units side by side on the same baffle without introducing serious interference effects. A slight "stereoscopic" effect is noticeable at

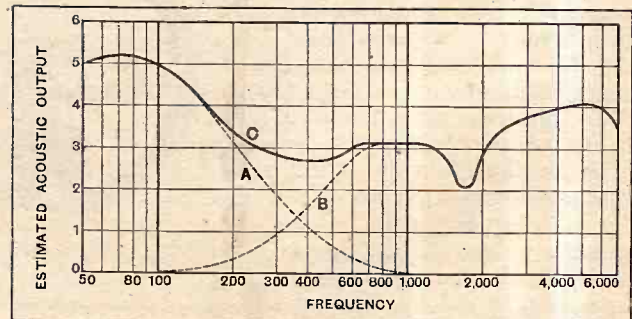

Fig. 4.—Estimated acoustic output. A, Ediswan unit with shunts; B, Mullard unit; C, combined units.

Dual Unit Loud Speaker.—

distances less than five or six feet, but this, in the writer's opinion, is an advantage, as it gives a two-dimensional impression when listening to, say, a violin and pianoforte recital. Those who may not like it have only to sit farther away from the loud speaker.

The depth occupied by the cone diaphragms behind the baffle does not exceed 3½ in., and the shallow cabinet shown in the photograph has been designed to stand on a mantelshelf 6 in. wide. The baffle board is covered with fabric and screwed from the inside to a fret ½ in. wide running round the front edge of the case. Strips of thin baize are inserted between the edge of the baffle and the fret, and baize rings are also laid under the cones before screwing down to prevent those elusive rattles that are the bane of home-constructed loud speakers. As a further precaution, flexible rubber-covered wire was used in preference to solid tinned copper for the connections to the resistance and by-pass condenser, while Litz wire was used for the leads from the two units.

In conclusion, the acoustic properties of the individual units and of the combination as a whole can be strikingly demonstrated if a single-pole, change-over switch is

included, as shown in Fig. 5. It is also convenient to make the 5,000-ohm resistance variable, as this gives a fine control over the balance between treble and bass to conform with individual taste. The resistance should have an "off" and "short-circuited" position.

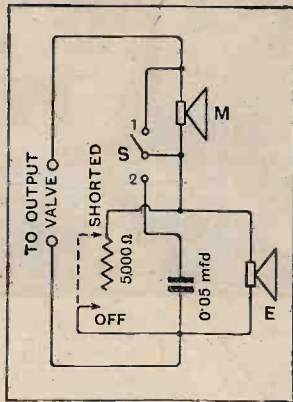

Fig. 5.—Switching arrangements for demonstrating acoustic output under various circuit conditions.

Then with the switch S in position 2 and the resistance shorted, the Mullard unit only will be in circuit, and the reproduction will be high-pitched. In order to test the qualities of the Ediswan unit alone without shunts, the resistance should be set in the "off" position and the switch at 1. By moving S to the "off" position the two units are connected in series without any correcting device, and it will be observed that the quality is very little different from that given by the Ediswan unit alone. The final arrangement with shunts is obtained by moving the switch back to position 2 and the resistance contact on to the free end of the resistance element so that the full 5,000 ohms is in circuit.

With this arrangement we have not only a first-class reproducer worthy of a receiver designed for quality, but also a means of demonstrating the functioning of the component parts of the loud speaker for the amusement and instruction of friends.

F. L. D.

AMPLIFIER DEFECTS REVEALED IN TELEVISION IMAGES.

In an article on the design and construction of receivers for Television, the Berlin weekly *Die Sendung* (April 18th, 1930) gives a list of common defects in a receiver-amplifier, and the symptoms by which these defects may be recognised. This list, which is dealt with below, contains one or two rather unexpected and not readily understood statements, which would appear to be of considerable interest in connection with Professor Appleton's recent observations¹ on the reception of ground- and space-wave images in Television.

It is assumed that the set is tuned-in on the Witzleben (Berlin) television test programmes sent out by the German Post Office.

The following faults may appear.—

(a) The picture is rather harsh, and following the dark edges there are often rather lighter "shadows," giving the "plastic" or solid effect shown in Fig. 1. This is attributed to the fact that the receiver is exaggerating the higher frequencies in the 300 to 6,500 cycle per sec. range, at the expense of the lower frequencies.

(b) The picture is very faint, and edges are wavy. If the subject is a head, the mouth and eyes are hardly distinguishable. The receiver is not paying proper attention to the higher frequencies.

(c) The picture is quite clear, but lighter shadows precede the dark parts. This defect, shown in Fig. 2, is a sign of too tight a reaction coupling.

(d) A combination of (a) and (c) gives shadows preceding and following the dark parts, which appear shut in on both sides, as in Fig. 3.

(e) Light shadows following a dark edge, but separated from it by a clear space, are attributed to some internal stray reaction in the amplifier. This defect, illustrated in Fig. 4, must be traced to the offending stage.

(f) The outline is harsh, without detail, and there is a lightish border all round. Too tight reaction coupling; the amplifier is being over-controlled. Reaction- and aerial-coupling should be reduced.

(g) Transitory dark streaks, appearing here and there without any connection with the picture, are the result of too much control of the glow lamp by the output of the amplifier. Either the permanent voltage on the lamp must be increased, or the amplifier output decreased, or both together.

Receiving from the London transmissions, the shadows would, of course, be above and below the images instead of to left and right of them, owing to the differing methods of scanning used in the two systems.

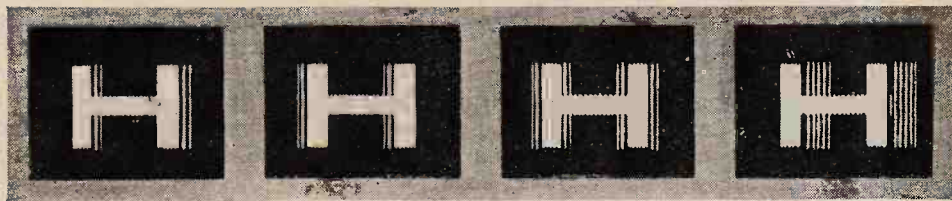

Fig. 1.—Higher frequencies accentuated.

Fig. 2.—Excessive reaction.

Fig. 3.—Over amplification of the higher frequencies and too much reaction.

Fig. 4.—Stray re-generation in the amplifier.

¹ *The Wireless World*, page 470, April 30th, 1930. See also "The Fading and Distortion of Distant Signals," by A. Dinsdale, page 504, May 14th, 1930.

The BAND PASS FILTER

Mis=tuning a
Ganged
Capacity=filter—

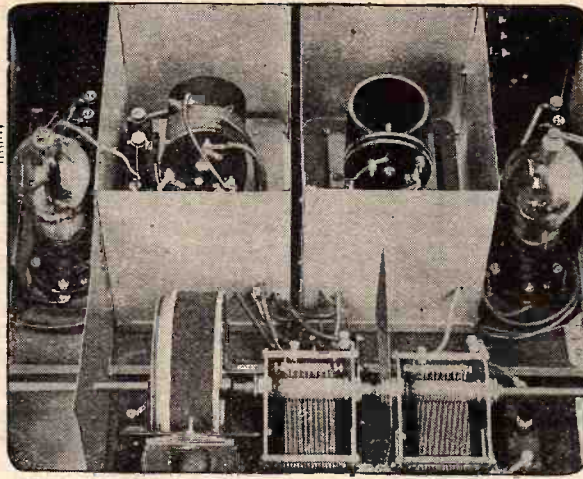

for the LONG WAVES

—to Obtain
High Quality and
Selectivity.

By W. T. COCKING.

THE design of high-frequency amplifiers for use on the long-wave broadcast band has been somewhat neglected of recent years. This has been due to the ease with which it is possible to obtain high amplification at these lower frequencies, and to the difficulties which, until recently, were attendant upon high-frequency amplification on the medium waveband. The position has now changed, for it is no longer considered that the H.F. amplifier fulfils its purpose by providing amplification alone; the conflicting problems of selectivity and quality are now of the very first importance.

It is well known that the band-pass filter provides one of the simplest means of obtaining high quality and selectivity in a medium-wave amplifier. It might seem, however, as tuning appears much flatter on the longer wavelengths, that sideband cutting is not so great; and, consequently, that ordinary cascade tuning circuits would give sufficiently good results. This is not the case, for it is based on a misconception; it is often thought that if the tuning control of a receiver is critical, the selectivity is high, and *vice versa*. In reality, the apparent sharpness of tuning is no guide whatever to the selectivity of a receiver. The dial settings are nearly always much less critical on the long waveband than on the medium, and yet the selectivity is usually much greater.

This can be readily understood when the normal circuit constants and conditions are examined. Suppose, for instance, that the range of frequencies from 1,500 kc. to 500 kc. (200-600 metres) can be covered by a movement of the condenser dial from 0° to 100°. Within this frequency band there is room for 100 stations spaced 10 kc. apart; consequently, if the condenser be of the S.L.F. type, the stations will come in 0.11 degree apart, and each should occupy one degree

on the dial. Now turn to the long waveband, the range of frequencies covered is from 300 kc. to 150 kc. (1,000-2,000 metres), and there is room for only 15 stations. But it requires the same movement of the dial to cover a frequency band of 150 kc. as it did on the shorter waveband to cover 1,000 kc. Tuning, therefore, appears to be much flatter, simply because a greater movement of the dial is necessary to change from one station to another. On the long waveband, the various stations would come in 6.66 degrees apart, and each should occupy that space on the dial. Tuning appears flatter on the long waveband because a given change in capacity causes a smaller change in the resonance frequency of a tuned circuit than is the case on the medium waveband.

MUCH attention has lately been given to the band-pass filter for the medium broadcast waves, but the problem of selectivity and high quality on the long waveband has been rather neglected. That the tuning on the long waves is comparatively flat is not an indication that sidebands are not being cut. This article describes the circuit conditions required for satisfactory sideband retention combined with a degree of selectivity necessary for the separation of stations on nearby wavelengths.

Whether the actual selectivity is greater or less on the long waveband depends upon the coil constants; in general, however, it is considerably greater, and the amount of sideband cutting is also greater. In this respect, it is worthy of note that the usual way of comparing coil efficiency by the coil magnification is useless as a basis of judging the selectivity of a circuit. The selectivity of a circuit depends not only upon the ratio of inductance to capacity and the coil H.F. resistance, but upon the frequency to which the circuit is tuned. It is well known that the ordinary tuned circuit on the medium waveband is much more selective for the higher values of tuning capacity than for the lower, and this is usually said to be due to the increased coil resistance at the higher frequencies. In actual fact, however, this is only partly true, for one of the chief factors affecting the selectivity is the frequency itself, as shown in the Appendix. If selectivity be defined as the reduction in current for a given *percentage* of de-tuning, then the selectivity is usually constant over the whole waveband. This is

The Band Pass Filter for the Long Waves.—

not a practical definition of selectivity, however, for broadcasting stations are equally spaced throughout the waveband; the only practical definition is for a reduction in current at a fixed number of kilocycles from resonance.

Now it will be seen that exactly the same effect takes place on the long waveband. The usual circuits have the same, or a little less, selectivity when this is defined upon a percentage basis, but as the carrier frequency is lower the actual selectivity for broadcasting purposes is greater. For instance, suppose that a number of tuned circuits give a constant reduction of current at a frequency 1 per cent. different from resonance, at 1,200 kc. this means 12 kc. off resonance, but at 600 kc. it is only 6 kc.; similarly, at 300 kc. this reduction is obtained at 3 kc. off tune, and when the circuits are tuned to 150 kc. the same degree of selectivity is obtained at only 1.5 kc. from resonance. It will be seen, therefore, that if the reduction be such as to give, without excessive sideband cutting, the correct degree of selectivity at 12 kc. off resonance when the receiver is tuned to 1,200 kc., the results at 150 kc. would be quite hopeless, for the same degree of selectivity would be obtained at 1.5 kc. off resonance, which frequency is well within the sideband range.

Avoiding High-note Loss on Long Waves.

The use of band-pass filters, therefore, is even more essential on the long waveband than on the medium. In general, the capacitatively coupled filter is superior to any form of inductive coupling, for the reason that it allows the band width to be kept more nearly constant as the tuning of the circuit is varied. In Fig. 1 are shown three curves for various circuits on the long waveband; curve A is for a single tuned circuit at 2,000 metres, with a coil inductance of 2,250 μ H. and an H.F. resistance of 50 ohms; curve B is for a band-pass filter at the same wavelength and having the same coil constants, but with a coupling condenser of 0.008 mfd.; and curve C is for the same filter at a wavelength of 1,000 metres, at which the coil resistance is 100 ohms. The filter is capacitatively coupled, and of the type shown in the circuit diagram of Fig. 2.

It will be seen that the sideband cutting of even a single tuned circuit is excessive at 2,000 metres, for the high-note loss reaches 65 per cent., but the selectivity

is quite high, being about 20 at 40 kc. off resonance. This is of about the same order as that obtained with a really low-loss litz-wound coil on the medium waveband, but the point to be emphasised is that this long-wave coil is by no means particularly efficient. It is readily possible to obtain plug-in commercial coils with a resistance of about 25 ohms, and by really careful design this figure can be lowered considerably. The use of low resistance coils should, therefore, never be attempted for broadcast reception on the long waveband; in cascade circuits they give far too great a high-note loss, and they are unsuited to band-pass filter characteristics.

Curve B of Fig. 1 shows that at 2,000 metres a band-pass filter with the same coils gives a decidedly double-

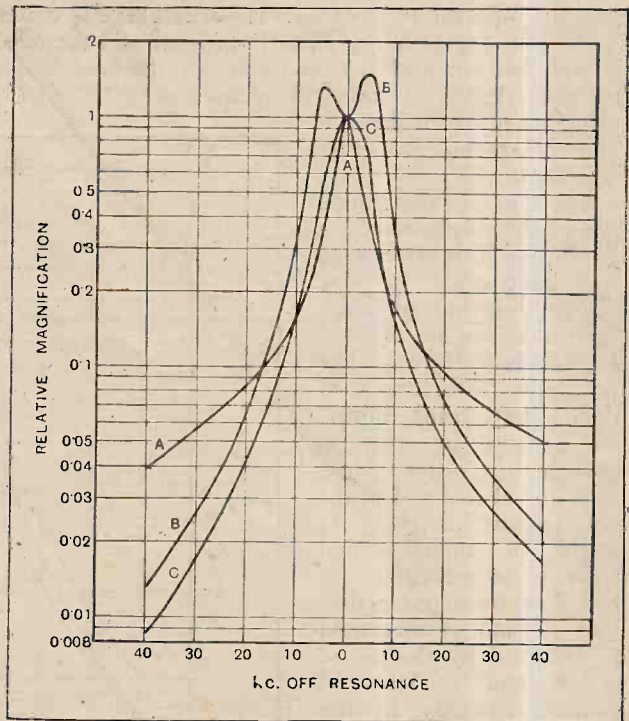

Fig. 1.—Resonance curves for three long-wave circuits. Curve A is for a single tuned circuit at 2,000 metres; curve B a band-pass filter at 2,000 metres, while curve C represents a band-pass filter at 1,000 metres.

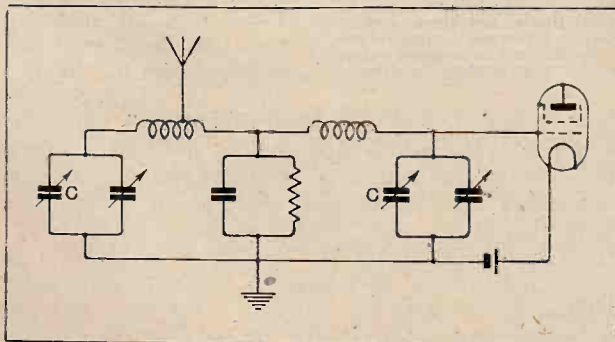

Fig. 2.—The capacity-coupled filter circuit.

peaked curve, and that the sideband variation is about 35 per cent., and, of course, in the form of a high-note accentuation. But when the curve for the same circuit at 1,000 metres (curve C) is examined, it will be found that there is a considerable high-note loss. The curve has become single-peaked, as is common with capacitatively coupled filters; but the high-note loss has now reached 50 per cent. A loss of this magnitude would not greatly matter if this filter were the only tuning circuit in a receiver, but when it is remembered that there will usually be at least two more tuned circuits, and that these will give a loss at least as great, it can be seen that the resonance curve is far too sharp.

It is evident from the theory of band-pass filters that the high-note loss can only be reduced by increasing the reactance of the coupling component, which means a

The Band Pass Filter for the Long Waves.—

smaller condenser, or by increasing the coil H.F. resistance, or both. Neither of these is very good, since the results at the longer wavelengths will inevitably be affected, and it is very desirable that the results at each end of the wavelength range should be as nearly alike as possible.

Now in a receiver employing band-pass filters the tuning condensers are usually ganged, and operated by a single control. Although it is often said that the ganging can be held perfectly over the whole wavelength range, in practice it is but rarely that one finds this to be the case. In general, no two circuits are tuned to exactly the same frequency, with the result that the amplification and selectivity are reduced by an amount depending upon the imperfections in the ganging, and the peak of the resonance curve is flatter. This applies to ordinary cascade circuits, and the effect is well known, and is responsible for the fact that a ganged receiver is more likely to give good quality than one in which the condensers are independently operated.

The effect of mis-tuning one of the condensers in a band-pass filter is not so well known; it is very similar, however, although the results are not affected to the same degree. The possibility thus arises of deliberately using imperfect ganging in order to prevent excessive high-note loss at one end of the wavelength range. It might be thought that there is no advantage to be gained by so doing, and that the same results could be obtained by the use of a different value of coupling capacity in the filter itself. This is not so, however, for the amount of mis-tuning can easily be arranged to vary with wavelength. The circuits, therefore, might be accurately tuned at one end of the range, where the filter is most effective, and gradually go out of tune as the wavelength is changed and the filter becomes less effective.

In this connection it must be remembered that no band-pass filter which is simple enough for general use is perfect. The width of the band of frequencies passed by the filter always varies with the wavelength to which it is tuned; and the extent of this variation and its direction depends upon whether inductive or capacitive coupling be used. Capacitive coupling is nearly always the better, since this variation in band width is

not only smaller, but the band width is narrowest at the lowest wavelengths, where the selectivity is usually least. On the medium waveband the circuit constants are usually such that a capacitatively coupled filter will give more or less constant selectivity and magnification over the whole waveband, while the sideband variation is nowhere excessive. Unfortunately, on the long waveband this is not the case, for, as the curves of Fig. 1 show, the high-note loss is far too great at the shorter wavelengths.

Inherent Mis-tuning.

Before one can say definitely how this scheme of using imperfect ganging will work it is necessary to investigate the amount of mis-tuning which will normally be obtained when accurate ganging is attempted; and the effect of such variations upon amplification, selectivity, and sideband variation. Having gained this information we can return to a consideration of the design of circuits to give a predetermined performance.

For it must be remembered that it is undesirable deliberately to mis-tune the circuits, as that would require elaborate measuring apparatus to ensure that the correct degree of mis-tuning was obtained. What we require is that the amount of inherent mis-tuning shall be of the correct amount, and vary in the correct manner, to give the desired results; the setting up of such a receiver would then only involve the attainment of the best possible ganging, following the usual practice.

Now, the sources of inaccurate ganging are chiefly the variable condensers, the coils, and the stray capacities. The latter are unimportant, since they can be accurately matched by the addition of equalising condensers. The coils, if machine-wound and carefully matched, are not likely to differ to an appreciable extent; but if they are hand-wound and unmatched they may vary by perhaps about 1 per cent., depending upon the care with which they are wound. Variable condensers are not usually matched to within closer limits than 1 per cent. The total variation likely in a carefully designed receiver, therefore, is about 2 per cent.; and this can be expressed as wholly capacitive without loss of accuracy. If care is not taken to match the components as accurately as possible the variation may be as high as 5 per cent. The curves of Fig. 3

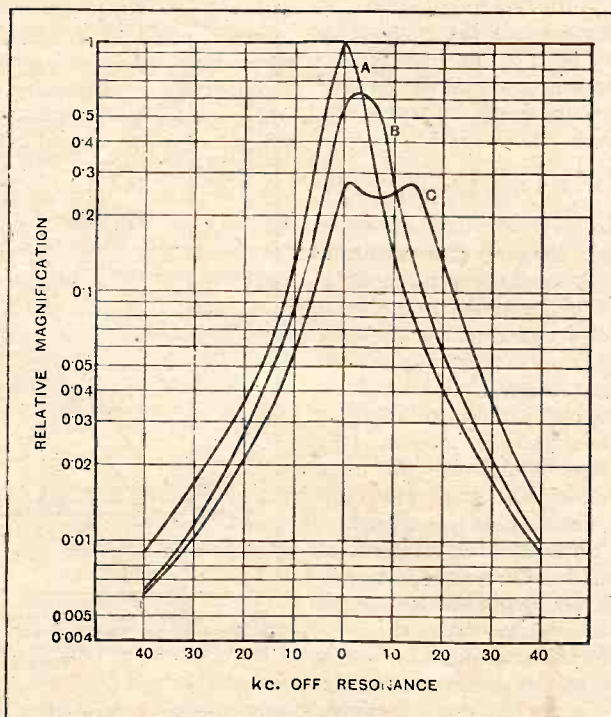

Fig. 3.—The result of mis-tuning two circuits in cascade at 500 metres. Curve A represents two cascade circuits tuned to resonance at 500 metres. Curve B, as above, but circuits mis-tuned. The capacity of one condenser is 2 per cent. higher than the other. Curve C represents the two circuits mis-tuned. The capacity of one condenser is 5 per cent. higher than the other.

The Band Pass Filter for the Long Waves.—

show the results of mis-tuning two circuits at a wavelength of 500 metres; each coil has an inductance of 200 μ H. with an H.F. resistance of 10 ohms, and the circuit is that of a single H.F. stage with tuned grid and anode circuits. Curve A is for both circuits accurately tuned, curve B for a 2 per cent. capacity

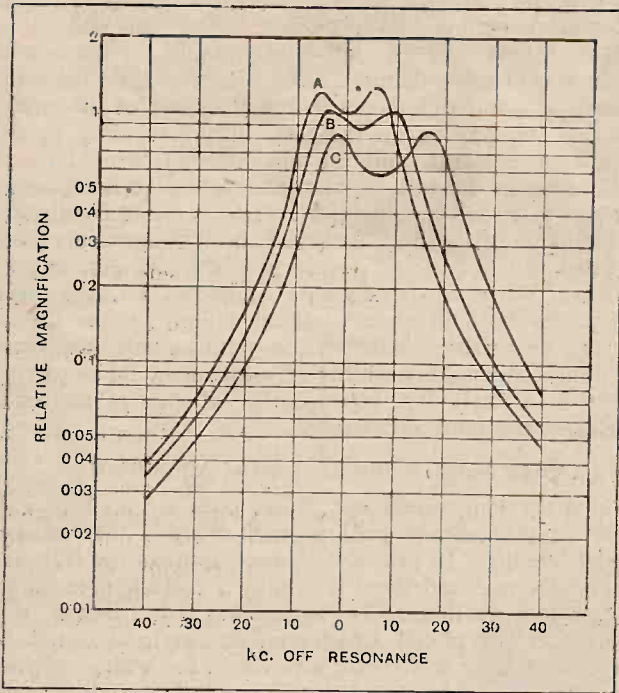

Fig. 4.—CURVES for a band-pass filter. Curve A is a band-pass filter at 500 metres, with both circuits accurately tuned. Curve B, as above, but one condenser with 2 per cent. higher capacity than the other. Curve C, as above, but one condenser with 5 per cent. higher capacity than the other.

increase in one circuit, and curve C for a 5 per cent. increase.

It is evident that there is a large loss in amplification consequent upon this mis-tuning, a 2 per cent. capacity change in one circuit reduces the amplification to 62 per cent., while a 5 per cent. change results in the amplification falling to 23 per cent. The selectivity, of course, is reduced also, but the quality is considerably improved; indeed, with the 5 per cent. capacity change the overall resonance curve has become double-peaked, and of the same type as that obtainable with a band-pass filter.

Cascade Circuit versus Filter.

The curves of Fig. 4 give the same information for a filter at the same wavelength and with the same coil constants; the coupling being by a fixed condenser of 0.015 mfd. Curve A is for both circuits tuned to resonance, curve B for a 2 per cent. capacity increase in one circuit, and curve C for a 5 per cent. increase. It is very interesting to compare the loss in amplification resulting from a given amount of mis-tuning in a band-pass filter with that in two cascade circuits. A 2 per cent. capacity change in a filter reduces the amplification to 87 per cent., but in the cascade circuit the reduction is

to 62 per cent. Similarly, with the 5 per cent. change the amplification falls to 32 per cent. with a cascade circuit, but with a filter it only falls to 55 per cent. It is evident, therefore, that the filter is of use apart from its invaluable property of improving the quality of reproduction, in that the loss in amplification and selectivity resulting from faulty ganging is not so great.

The Cause of Double Tuning.

If the curves of Fig. 4 be examined, it will be found that as the discrepancy in the ganging increases the curve as a whole tends to become tilted sideways, and the selectivity on one side of resonance to become greater than upon the other side. As the capacity increases, the peak of the curve, or the trough in the case of the double-peaked curve, occurs at a lower frequency, and, in addition, the two peaks are often of different heights. This last point is often very evident in practice, when setting up a receiver and before the ganging is adjusted properly. As the tuning control is rotated it is found that there are two widely separated settings at which a station can be received, and that the strength at one of these settings is much greater than at the other. Whenever this effect is found, it is a sign that the ganging is incorrect; and when it is distinctly noticeable the ganging is badly at fault.

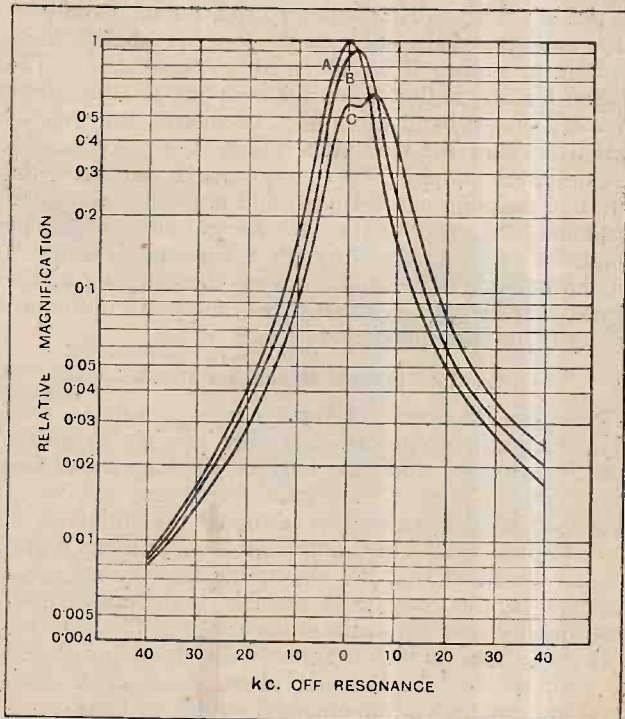

Fig. 5.—The effect of mis-tuning in a band-pass filter at 1,000 metres. Curve A represents a band-pass filter at 1,000 metres, where both circuits are accurately tuned. Curve B, as above, but one condenser with a capacity 2 per cent. higher than the other. Curve C, as above, but one condenser with a capacity 5 per cent. higher than the other.

Now it is obvious that on the long waveband, owing to the lower frequency, a given percentage change in a capacity will result in a smaller difference between the resonant frequencies of different circuits; one would

The Band Pass Filter for the Long Waves.—

expect, therefore, that ganging would not be so critical on these wavelengths. Just what results will be obtained is a little difficult to predict without calculating the resonance curves; for the curves are so much sharper than those for the medium waveband. The curves of Fig. 5 are given, therefore, to illustrate the effect of various amounts of mis-tuning at a wavelength of 1,000 metres. It is unnecessary to give curves for a wavelength of 2,000 metres, since the change is then so small as to be negligible.

Curve A is for a band-pass filter of the constants mentioned earlier, and with both circuits accurately tuned; curve B is for a 2 per cent. capacity increase in one circuit; and curve C is for a 5 per cent. capacity increase. It will be seen that the above statement is borne out, for even at 1,000 metres a 2 per cent. capacity variation makes only a slight difference to the results; while a 5 per cent. variation gives a tuning curve which would be very satisfactory from the point of view of quality. The selectivity, too, is quite high; but the amplification falls rather considerably, the reduction being about 46 per cent. This, however, is not as bad as it may seem, since on the long waveband the amplification varies much more rapidly with wavelength than it does on the medium waveband; it is often three times as great at 1,000 metres as at 2,000 metres. The variation is not always as great as this when cascade circuits are used, for the band-pass filter accentuates the effect on the long waveband, while tending to reduce it on the medium waveband. The reason for this is that when the coupling is adjusted to give the correct band width at 2,000 metres, the amplification is below the maximum which is obtainable with the optimum coupling. At 1,000 metres, however, the effective coupling has changed, and is usually about the optimum; thus accentuating the normal effect of higher amplification at this wavelength. The case is different on the medium waveband, because the coupling at the lowest wavelengths is usually less than the optimum, giving reduced amplification.

On the Medium Broadcast Band.

From an inspection of these curves it will be seen that, with simple circuits, it is only possible to obtain both high quality and selectivity on the long waveband by a combination of band-pass filters and mis-tuned circuits. At the highest wavelengths the filters serve alone to preserve the high notes, while at the lower wavelengths the filters and the mis-tuning have about equal effects. In this way it is possible to maintain first-class quality over the entire wave range of the receiver.

It would now be well to state briefly the requirements for such results. In the first place, the desired selectivity and quality can be obtained on the medium waveband by the use of capacitatively coupled band-pass filters with all the circuits accurately tuned. From the various curves which illustrate this article it can be seen that the maximum permissible variation in inductance or capacity between different circuits is about 2 per cent., and that it should preferably be less; also, that if variation is unavoidable it should take place at the higher wavelengths within the tuning range. On the long waveband, however, the circuits should be

matched as accurately as possible at the long wave end of the range, but a variation of 2 per cent. makes a negligible difference to the results. At a wavelength of about 1,000 metres, however, a variation of about 5 per cent. is definitely desirable in order to avoid excessive sideband cutting.

Now to put this into practical form. On the medium waveband it is well to take every precaution to obtain correct matching of the circuits. The coils should be carefully wound; all coils being wound on formers of exactly the same diameter, and with wire from the same reel, to avoid differences in the thickness of the covering. The tension on the wire during winding should be kept constant, and the finished coils should be so mounted in the receiver that their effective inductances when in circuit are identical. The variable condensers should be of the best quality, and all components associated with the tuning circuits should be as alike as possible. When the receiver is connected up, the stray capacities should be carefully equalised by the use of small adjustable condensers in parallel with the main tuning condensers, and this adjustment should be carried out on a fairly low wavelength; about 275 metres is usually the most satisfactory.

High Notes at the Expense of Amplification.

On the long waveband, if the coils are all identical, the ganging should hold as well as upon the medium wavelengths. In practice, however, unless the coils are carefully matched there is usually a considerable difference between them. The writer has found that a very compact type of coil, which consists merely of a grooved ebonite former with a slot into which the wire is wound, has very suitable characteristics. With a small amount of care in winding to keep them as alike as possible, the differences between different coils are of just about the correct order to give first-class quality on the long waveband without an excessive loss in amplification.

In practice, the assembled receiver should be ganged as perfectly as possible on the medium waveband by the use of the equalising condensers, shown at C in Fig. 2, while the ganging on the long waveband is left severely alone. By this procedure a receiver which at no part of its range gives excessive sideband cutting can be readily built, but care must be taken in its design, and particularly in the choice of the inductances for the long waveband.

This desirable achievement of a small amount of sideband cutting is, of course, attained at the expense of amplification; and two stages of H.F. amplification are necessary unless one is content with only the strongest of the Continental stations. It results, however, in a single control receiver, or nearly a single control, for it is sometimes found that the aerial circuit cannot be ganged on both wave ranges with sufficient accuracy, and in this case it is necessary to add an auxiliary tuning condenser. Although a certain amount of amplification is lost through the imperfections in ganging, this need cause no anxiety, for the amplification given by many modern receivers is greater than is strictly necessary. The use of band-pass filters with ganged condensers, then, allows the attainment of first-class quality at the sacrifice of a certain amount of amplification.

The Band Pass Filter for the Long Waves.—
APPENDIX.

The current I in a series resonant circuit tuned to resonance is given by

$$I = E/R$$

and by

$$I_1 = \frac{E}{\sqrt{R^2 + (wL - 1/wc)^2}}$$

at a given frequency different from resonance.

The selectivity, therefore, may be defined as

$$\frac{I}{I_1} = \frac{\sqrt{R^2 + (wL - 1/wc)^2}}{R}$$

Now if the two frequencies in this formula be each doubled,

the capacity must be reduced to one-quarter in order to maintain resonance, and the H.F. resistance is then usually doubled. It should be noted, however, that the coil magnification is unchanged, since both the coil reactance and the H.F. resistance are doubled at the higher frequency. The selectivity then becomes

$$\frac{\sqrt{4R^2 + (2wL - 2/wc)^2}}{2R}$$

which upon simplification is the same as before, but with one very important difference. Since the resonance frequency and the given frequency off resonance have each been doubled, their difference has also been doubled. The selectivity, therefore, is constant only for a given *percentage* change in frequency, not for a constant frequency difference.

UNLIMITEX COMPONENTS.

Some samples of the components made by the Wireless Supplies Unlimited, 278, High Street, Stratford, London, E.15, and marketed under the trade name of "Unlimitex," have been sent in for test. These comprise wire-wound resistances and fixed condensers.

The resistances are non-inductively wound on a slotted ebonite former, using the heaviest gauge of wire that can be accommodated in the available space having regard to the resistance value required. The current-carrying capacity is, therefore, the maximum for the dimensions, and the particular method of construction adopted. The standard values are: 1,000 to 5,000 ohms in steps of 1,000 ohms; 10,000 to 60,000 ohms in steps of 10,000 ohms; and 100,000, 200,000 and 250,000 ohms. Prices range from 2s. 3d. for values up to 40,000 ohms; 3s. from 50,000 to 100,000 ohms; and the larger sizes 3s. 9d. each.

The resistance bobbin is enclosed in a metal tube provided with ventilation holes and two ebonite end caps carrying small terminals. The outside dimensions are 2in. long and 3/4in. in diameter. Two 20,000-ohm samples were measured, the actual values being 18,200 ohms and 17,800 ohms respectively. A special holder can be obtained for these at the price of 6d.

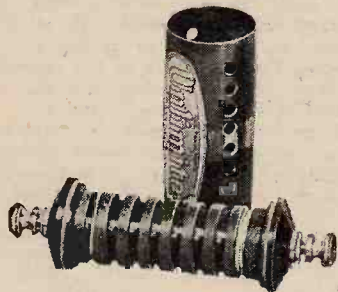

"Unlimitex" wire-wound resistance dismantled to show the sectional wound bobbin. It is non-inductive.

The fixed condensers are assembled in neat bakelite cases provided with lugs for upright mounting and holes to enable them to be laid flat if desired, the terminals being placed to suit either arrangement. Circular copper foil plates interleaved with discs of ruby mica constitute the condenser, and provision is made for accurate adjustment of the capacity before the sealing compound is run in. The standard

LABORATORY TESTS
New Apparatus
Reviewed.

values available range from 0.0001 mfd. to 0.001 mfd., the price of these being 1s. each; and from 0.002 to 0.006 mfd., at 1s. 3d. each. The 0.01 mfd. size costs 1s. 9d.



"Unlimitex" fixed condenser together with assembled wire-wound resistance.

"GODWINEX" MODEL A.S.H.
A.C. ELIMINATOR.

This is a recent addition to the "Godwinex" range of battery eliminators made by Messrs. J. Dyson and Co., Ltd., St. Stephen's House, 2, Coleman Street, London, E.C.2, the price being £3 17s. 6d. A Westinghouse metal rectifying bar of the half-wave type is incorporated and provision is made to obtain three different output voltages, all of which are of fixed value. The unit is intended for use with sets embodying a screen-grid high-frequency stage, so that one of the output voltages has been adjusted to suit the needs of the screen grid in the H.F. valve. The voltage at this point is derived from a potentiometer, and as a consequence this output should remain unaffected by slight changes of current in this circuit. The voltage at the H.T. +1 tapping is regulated by a fixed series resistance which should serve, also, as a decoupling resistance for the detector stage.

Some measurements were made of the D.C. output, on load, from the highest

voltage tapping, as it is from this tapping that the heaviest currents will be drawn.

Current in mA.	D.C. volts.	Current in mA.	D.C. volts.
2	168	12	138
4	162	14	131
6	156	16	126
8	150	18	120
10	144	20	115

The input voltage at the time of test was 240 A.C. at 50 cycles. A further measurement made under normal working conditions showed that, when supplying a 1-v-1 receiver, the screen grid received 60 volts at 0.4 mA. and the detector and output stages—*anode bend* being used—140 volts at 11 milliamps.

The unit is enclosed in an oxidised metal case, which can be earthed if necessary.



"Godwinex" Model A.S.H. battery eliminator for A.C. mains, suitable for sets incorporating one screen-grid H.F. valve.

Catalogues Received.

Philips Lamps, Ltd., Philips House, 145, Charing Cross Road, London, W.C.2.—Illustrated folder dealing with the Philips four-valve portable receiver.

Higgs Motors, Witton, Birmingham.—April, 1930, stock list of repulsion start induction motors for single and poly-phase supplies, also D.C. dynamos and motors.

CURRENT

TOPICS

ARE YOU A "WAC?"

While every transmitting amateur, whatever his nation or colour, can lay just claim to the title OM, comparatively few are entitled to flourish the letters WAC, which now appear in a number of lists. The coveted letters stand for "worked all continents."

○○○○

BOURNEMOUTH'S WIRELESS CLAIM.

Bournemouth claims to be the most "wireless" district in the country. According to figures disclosed by Mr. S. Goodyear, engineer-in-charge at the Bournemouth Broadcasting Station, the number of wireless licences held in the local postal area is almost equal to the number of houses. Licensees number 156 per thousand of the population.

○○○○

DECREE AGAINST MAN-MADE STATIC.

The municipality of Bockenem (Hanover) has set an excellent example to the rest of Europe by introducing special measures to prevent electrical interference with wireless reception. In a décret just issued, the use of all high-tension apparatus is forbidden unless it bears the Government stamp signifying that no undesirable radiations are produced.

○○○○

ITALIAN "PIRATE" HUNT.

The uncomfortable conviction that only 25 per cent. of the broadcast listeners in Italy are duly licensed has led the Italian broadcasting authorities to plan a wholesale "comb out" by means of a radio census. We understand that the Italian State means to enforce the completion of the census form under pain of strong penalties. All householders and tenants will be required to send in returns stating whether a set is in use and giving particulars of make and type.

○○○○

TELEPHONING FROM THE HOMERIC.

No testimony to the excellence of the radiotelephony service between the R.M.S. *Homeric* and the shore could have been more convincing than that afforded by the recent broadcast conversation between Mr. Harold Nicolson in the London studio and a passenger on the liner.

While the Post Office stations at Rugby and Baldock are used at the shore end, the apparatus on the *Homeric* is a product of the Marconi International Marine Communication Co., Ltd., being a replica of the short-wave equipment used by Senatore Marconi on the *Elettra* in his talks with Australia. The telephone installation operates on wavelengths of about 24 and 70 metres with a power of 2 kW. in the aerial. An important new feature is the provision of a special valve drive corrected for temperature variation to ensure absolute constancy of wavelength.

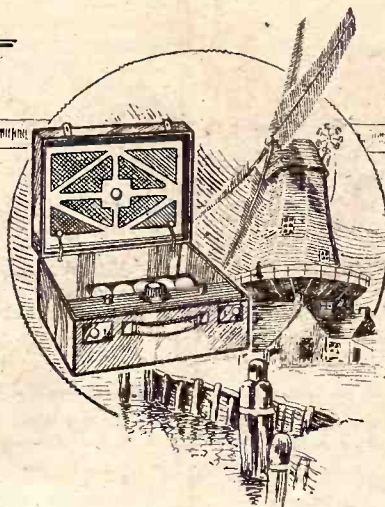
Events of the Week
in Brief Review.

GERMANS BANNED FROM PARIS SHOW.

German exhibitors will be banned from the autumn International Wireless Show in Paris. This decision of the French Radio Manufacturers' Association is the outcome of a refusal by the German authorities to admit French or other

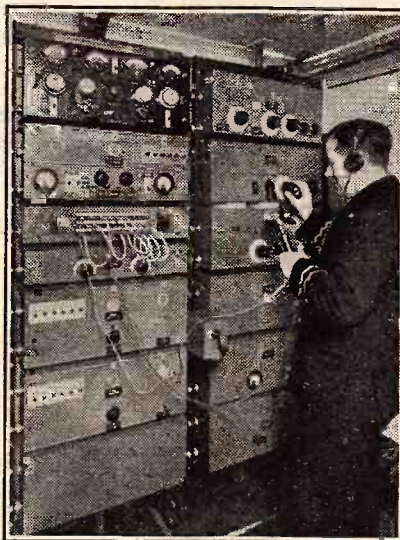

TELEPHONING FROM MID-ATLANTIC.
An operator adjusting the Marconi short-wave receiver installed on the R.M.S. *Homeric*. The newly opened telephone service is referred to in the adjoining column.

foreign wireless apparatus to the forthcoming Berlin Radio Show, which is described as "purely national."

○○○○

1930 BURNDY PORTABLE.

In the review of this receiver on page 624 of our previous issue a printer's error occurred in line 11 of the right-hand column. The waveband occupied by the London Regional transmitter was from 345 to 365 metres, not 565, as stated.

U.S. RADIO JAM.

During the first four months of this year the American Federal Radio Commission received 114 applications for permits to erect new broadcasting stations. In nearly every case the requests have been refused, despite the fact that many were supported by strong political interests.

The commission makes the confession that with 600 stations in operation the air is already overcrowded and little encouragement can be given even to those who want low-power local stations.

○○○○

THE R.A.F. DISPLAY.

Wireless will again make possible many thrilling aerial events at this year's Royal Air Force Display at Hendon on Saturday, June 28th.

The programme is thoroughly representative of the Service work of the Royal Air Force, and illustrates some of the many varied duties which the flying service undertakes at home and abroad. In the "set piece," which this year centres round the destruction of a pirate stronghold, will be seen aircraft similar to those utilised in rescuing the European and Indian population in Afghanistan last year, while the bombers and fighters which also take part in this thrilling "battle" will demonstrate the utility of aircraft in other directions.

○○○○

FRENCH MANUFACTURERS ATTACK GOVERNMENT.

A solemn resolution condemning the dilatory methods of the French Government on the question of the promised Broadcasting Bill has been passed by the French Radio Manufacturers' Association. The assembly considered that "the present Government has hitherto shown itself incapable of establishing the necessary wireless statute; it is thus allowing an industry to perish and is sacrificing for the benefit of the foreigner the most efficient instrument for the diffusion of French thought and art."

The projected Bill seeks to terminate the existing chaos in the French ether by regularising the ownership of stations and introducing a measure of State control.

○○○○

HOW THEY LISTEN IN AMERICA.

The wireless audience in America now numbers 52,581,840, with 12,824,800 families, or 43 per cent. of the total population owning sets, according to a revised survey made for the National Broadcasting Company by a Cambridge, Mass., statistician.

Among other interesting points in the survey are the following: Over 75 per cent. of the sets in use have more than five valves; 81 per cent. of listeners use their sets two hours daily; the most popular listening period is between 8 and 10 p.m.; more than 52 per cent. of listeners own sets over two years old.

The N.B.C. estimates that it has a nightly audience of 7,000,000.

Broadcast Receivers Reviewed

A.C. Mains
Model.



A "Sports Model"
for the
Enthusiast.

BURNDIPT
*Universal
Screened Five*

THE listening public can be conveniently divided into two main categories: (a) those whose interest is centred mainly in the programmes transmitted by the B.B.C. and who demand of any receiving set that it shall give the most faithful quality of reproduction available at the price they are prepared to pay, and (b) enthusiasts whose hobby is the reception of long-distance transmissions, and whose primary interest lies in the direction of extracting the last ounce of efficiency from a receiver by skilful manipulation of the controls.

There is, however, an ever growing section of the community whose interest in wireless embraces both these categories, and to this class the Burndept Universal Screened Five should make a special appeal. The circuit incorporates every conceivable adjustment and control—the wave range includes ultra-short wavelengths, and there are three degrees of selectivity on each wave band—yet the quality and volume of reproduction of nearby stations should satisfy the most critical musician.

There are four stages in the receiver, including one stage of screen-grid H.F. amplification, a reacting grid detector resistance-coupled to the first L.F. stage, which is in turn transformer-coupled to the two push-pull output valves in the last stage. Including the full-wave rectifier in the power unit there are, in all, six valves in the set.

The aerial-circuit tuner comprises three separate coils connected in series and tuned by a 0.00033-mfd. log-law condenser. A compound rotary selector switch on the left of the control panel switches in the appropriate coils and provides three wavebands, viz., 16 to 38 metres, 220 to 560 metres, and 900 to 2,100 metres. The switch is also provided with groups of three contacts on each waveband, giving three degrees of selectivity (and signal strength) on each range. The aerial is coupled to the tuned circuits by including a few

turns near the earth end of each inductance. In the case of the medium- and long-wave ranges these contacts are arranged to vary the number of turns included in the aerial circuit, while on the short-wave band contact No. 1 connects the aerial to the mid-point of the inductance, No. 2 introduces a small condenser in series with the lead to the centre point of the tuning coil, and No. 3 contact is open. In the latter position the coupling between the aerial and the tuner is provided by the minute capacity between the switch contacts.

The H.F. Stage.

The screen-grid H.F. valve used in the particular receiver tested was a Mullard S.4V., with a nominal A.C. resistance of 1,330,000 ohms and amplification factor of 1,000. Grid bias is derived from the volt drop in a resistance (R_1 , Fig. 1) connected between the cathode and H.T. negative and traversed by the valve anode current. This resistance is made variable and serves as a volume control by over-biasing the grid of the valve. As the resistance is increased the negative bias also increases; but the anode current, which is the source of the volt drop in the resistance, is, at the same time, decreased. Hence a point is reached at which further increase in the value of R_1 would normally produce only a small increase in bias and consequent reduction in volume. The practical result of this condition would be that the volume control would be incapable of reducing signal strength to zero. To avoid this difficulty the volume control has been arranged to form part of the screen-grid potentiometer circuit, as shown in Fig. 1. The potentiometer current, which remains practically constant, is thus able to produce the necessary additional negative bias required to reduce signal strength to zero. In practice this arrangement also gives a much more even control of volume over the range of movement of the control.

Tuned-anode coupling is employed between the H.F. valve and the detector, the circuit being shown schematically in Fig. 2. To avoid complication the anode coil is shown as a single inductance, but there are actually three separate coils, with associated short-

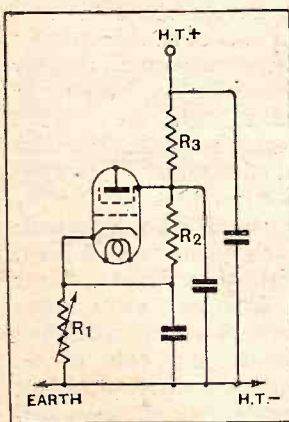

Fig. 1.—Volume control connections. The resistance R_1 controls the working-grid potential of the screen-grid valve.

Broadcast Receivers Reviewed.—

circuiting contacts, in the control switch on the right of the tuning panel. The H.T. feeder is tapped near the centre of the coil, and reaction is obtained by means of a small variable condenser R.C., connected between the "free" end of the coil and the detector anode. The tuning condenser is of the dual-capacity type, only three pairs of vanes being used on the ultra-short range. For medium and long waves the remainder of the condenser is brought into play by contacts on the control switch. An additional contact short-circuits the lower section of the anode inductance when reproducing gramophone records, thus effectively preventing the superimposing of a background of stray radio signals. By careful design of the condenser vanes and precision methods of manufacture and testing of both coils and condenser it has been found possible to fit the anode-circuit tuning dial with a printed scale calibrated directly in wavelengths. The accuracy of this scale depends upon the attainment of a calculated initial fixed capacity, and for this purpose a small semi-fixed balancing condenser B.C. is included. This is adjusted and sealed before the receiver leaves the works, and should on no account be disturbed.

Gramophone Pick-up Connections.

A Mullard 354V. indirectly heated valve (amplification factor 35, A.C. resistance 14,000 ohms) is used for detection, and operates with zero grid bias, which ensures smooth reaction control. When the control switch is moved to the "Gram." position the bias is automatically changed to 3 volts negative, which converts the valve into an L.F. amplifier. A decoupling resistance is inserted in the grid lead from the pick-up terminals, and this absorbs any induction in the pick-up leads which might otherwise be transferred to the grid through the switch capacity while listening to broadcasting. This precaution enables the pick-up to be connected permanently to the set if so desired. The main volume control does not function with the pick-up in circuit, and an external volume control must be fitted.

The first L.F. valve is also a Mullard 354V., and is resistance-coupled to the detector. A series grid resistance is used to suppress any remaining traces of H.F. after rectification. A grid bias of -3 volts is derived from a separate Westinghouse rectifier and potentiometer in the power supply unit. The grid bias of 30 to 40 volts for the push-pull output valves is drawn from the same source and may be adjusted to suit the characteristics of the particular valves employed.

The output is derived from two Marconi-Osram P.625A. valves, coupled, both as regards input and output, by Ferranti transformers. The output transformer has a tapped secondary suitable for both high- and low-impedance loud speakers. A milliammeter mounted on the front panel is connected permanently in series with the H.T. supply to the last two valves, and not only serves as a visual indication of the behaviour of the receiver, but is also useful in checking and matching the emission of the output valves and in tracing faults.

The power unit is constructed as a separate screened unit, and is mounted at the left-hand side of the receiver chassis to which it is connected by means of a

multiple terminal strip. In addition to the Philips 506 full-wave rectifier and smoothing circuits for H.T. supply, there is the separate Westinghouse rectifier for the grid bias to the L.F. valves. The mains transformer, which has a tapped primary for supply voltages of 100-110, 200-220, or 225-240 volts, also has a filament heater winding with two tapplings, one for supplying the 4-volt heaters of the H.F., detector and first L.F. valves, and the other for the 6-volt filaments of the P.625A valves which are directly heated. The difference of 2 volts between the L.T. leads is used to light

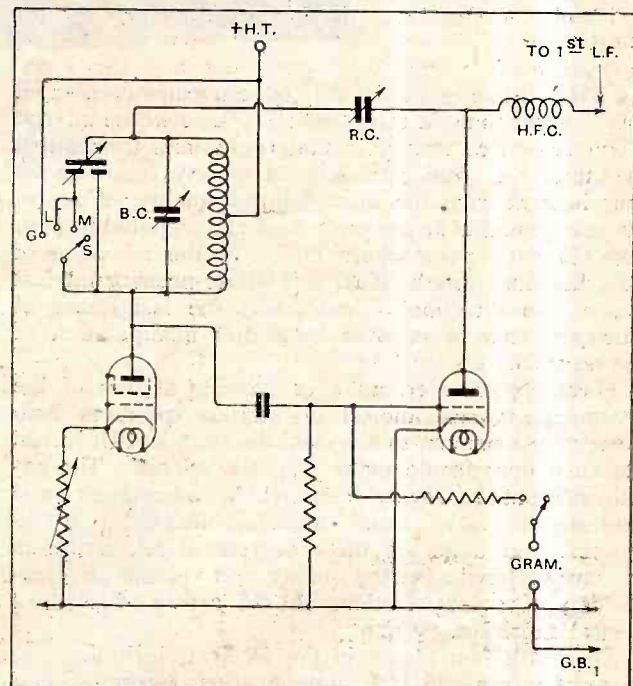

Fig. 2.—Detector circuit showing tuned anode coupling and method of connecting the gramophone pick-up.

the pilot lamp, which has a 3.5 volt filament and, therefore, lasts indefinitely.

The receiver was tested both in central London and at a place only five miles from Brookmans Park.

The performance on short waves is of special interest for two reasons. In the first place, one may reasonably ask "Has efficiency been sacrificed by the necessarily complicated switching associated with three wave ranges?" Secondly, "Is it possible successfully to run a short-wave receiver through an eliminator?" Dealing with the second question first, we can confidently reply in the affirmative. Over four-fifths of the tuning scale on short waves there is not the slightest trace of hum, even when the receiver is in a state of oscillation. Near the lower end of the scale, *i.e.*, from 18 metres downwards, there is a definite 50-cycle hum which is irritating when the set is put into oscillation, but only causes slight modulation of the signal if the set is worked just off the oscillation point. Fortunately, the most important station near the bottom of the scale, *viz.*, Schenectady (W2XAD, 19.56 metres) is well clear of the affected zone, and during the tests came in at full loud-speaker strength

Broadcast Receivers Reviewed.—

for a period of several hours. The quality of reproduction, too, was excellent, as there was very little fading and a complete absence of atmospherics at the time. In fact, this station has never been better received, even on sets designed exclusively for ultra-short waves.

But the star performance was given by Zeesen (31.38 metres). When first picked up this transmission was so steady and the quality so good that a harmonic of Brookmans Park was suspected (the set was operating within sight of the aerials). There can be no doubt that far from being a passenger, the screen-grid valve makes a definite contribution to the overall efficiency on ultra-short waves. Other outstandingly good short-wave stations were Lyngby (31.6 metres) and the transatlantic telephone service on 20.7 and 22.4 metres. Hand capacity is absolutely negligible, and does not change the frequency more than 50 cycles in 10 million; there is no trace of backlash or threshold howl at any part of the tuning range. The only possible improvement on the ultra short wave range would be the provision of either a larger reaction condenser dial or a subsidiary vernier control.

As regards range and sensitivity, the performance on the all-important 220-560-metre band is above the

central London, and at a distance of fourteen miles.

Position No. 2 on the selector switch may be used when listening to the B.B.C. programmes, and is preferable from the point of view of quality. The selectivity in position No. 1 is sufficient to separate the Regional stations in London, but its usefulness would be better appreciated in, say, Devon or Cornwall, where range is of greater importance than selectivity.

Similarly the No. 1 selectivity is of little use on long waves as 5GB then intrudes over the lower part of the dial. This interference, however, disappears on tapping No. 2, and 5XX and Radio Paris can be separated without reaction. Position No. 3 enables Königswusterhausen to be received clear of both the former stations by judicious manipulation of reaction. All the principal long-wave stations, Huizen, Radio Paris, Eiffel Tower, Kalundborg, Hilversum, and Croydon Aerodrome come in reliably at all times.

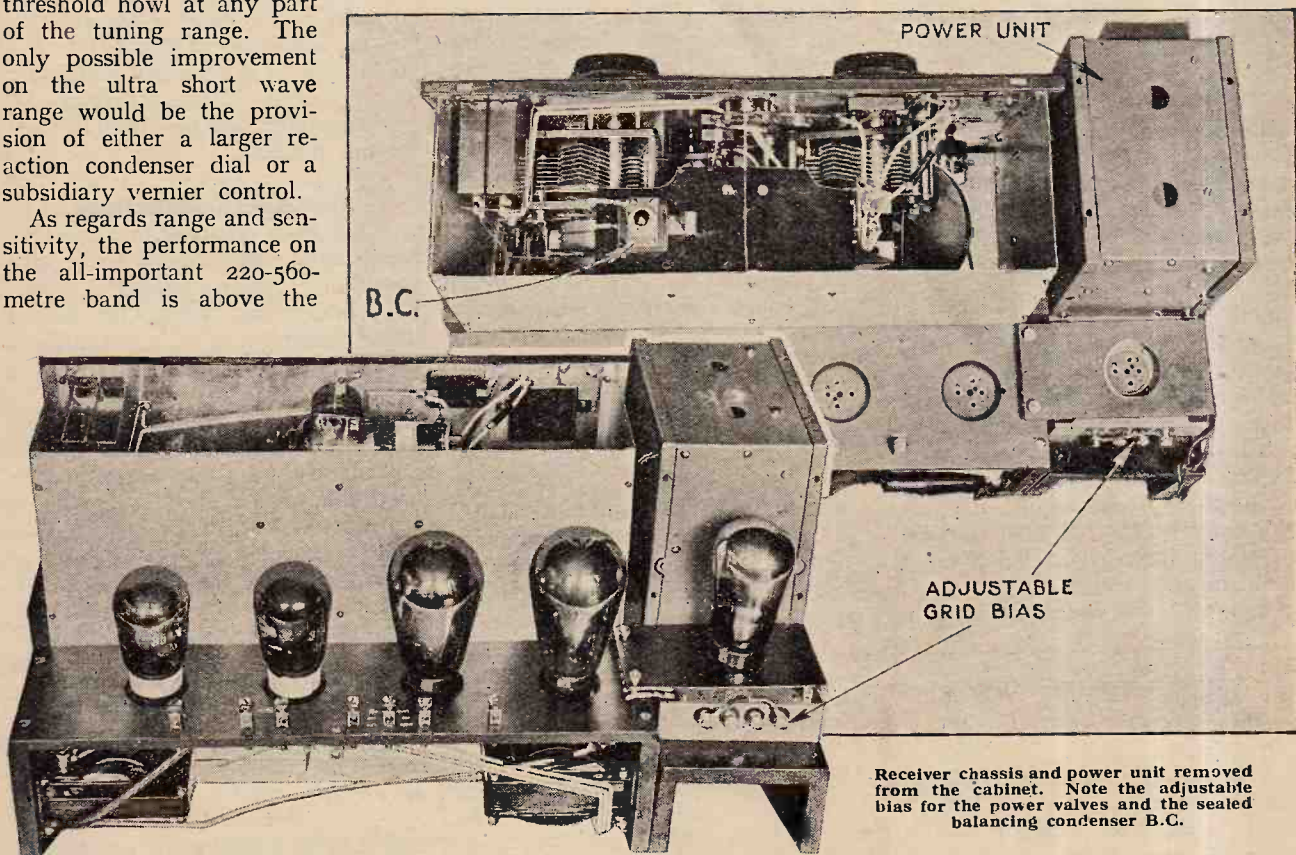

average, having regard to the fact that only a single H.F. stage is employed. Twelve continental stations were received at good loud speaker strength—many without having resort to reaction—on an aerial less than 50ft. long. For all these stations the No. 3 selectivity tapping was used. This gives the highest degree of selectivity, and should always be used in the London area for long-distance reception. In this position London Regional (356 metres) spreads from 330 to 385 metres, and London National (261 metres) from 230 to 300 metres, these readings being taken in

Only a good moving-coil loud speaker can do justice to the quality and volume of the output from the two P.625A valves, and the performance in this respect is not inferior to the best radio-gramophone receivers designed exclusively for quality reproduction. Taking into consideration its versatility in other directions, the Burndept Universal Screened Five may be regarded as a "Sports Model" among radio receivers.

The price of the A.C. model, complete with valves, but without loud speaker or pick-up, is 39 guineas. A battery-driven model is also available at 30 guineas.

Practical

Hints & Tips

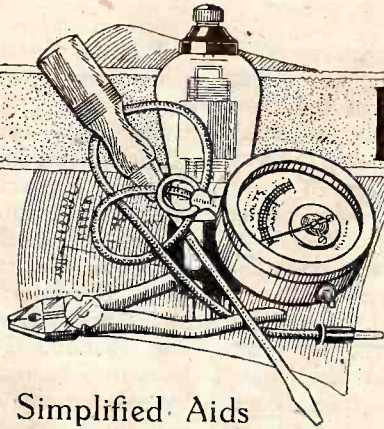

Simplified Aids
to Better Reception.

ISOLATED H.F. VALVES.

In designing a receiver with two or more high-frequency amplifying stages, it is usual to isolate the screen grid valves from the tuned circuit components—coils and condensers—by means of metallic screening. This precaution need hardly be taken in the case of a set of ordinary type having but a single H.F. valve, but there is some advantage in observing it when one is aiming at the highest possible efficiency.

o o o

ELIMINATOR IMPEDANCE.

In discussing in these notes the question of interstage couplings brought about by an eliminator impedance common to several circuits, it was stated some time ago that in certain circumstances it might be desirable to provide separately smoothed outputs for feeding individual valves of a receiver, or at any rate for those valves between which harmful interaction is likely to take place. It might perhaps have been added that, without going to such lengths, a similar effect can often be produced by reducing the effective impedance of the common smoothing circuit included in the average eliminator.

Obviously, this cannot be brought

smoothed output; this capacity is shown at C in Fig. 1, which represents a popular and effective type of eliminator for D.C. mains. It should be emphasised, however, that the principle applies equally to A.C. eliminators.

In obstinate cases it may be of advantage at least to double the conventional capacity value—four to six mfd.—that is usually specified for this position.

Of course, there is no need to “scrap” the existing condenser and to replace it by another of the desired value; the most economical procedure is to add the necessary extra condenser (or condensers) in parallel.

o o o

SELECTIVITY AND SCREEN GRID VALVES.

Poor selectivity, particularly of the kind which manifests itself as interference from a comparatively near-

eliminate, as the addition of succeeding H.F. amplifiers, even with good tuned couplings, has no effect in reducing it. The real remedy, of course, is to minimise the input of interfering signals to the first grid by a well-designed filter or two-circuit aerial tuner, but it is sometimes possible to effect a distinct improvement by applying more suitable grid bias, screen, or anode voltages to the valve. It is generally simple enough to make a change in H.T. pressure, but the alteration of grid bias is not so easy, as it is usually supplied by a single cell of fixed voltage. A potentiometer must generally be used for this purpose.

o o o o

BREAKING CONNECTIONS.

It has been observed that amateur constructors are almost invariably unwilling to remove internal connecting wires when testing for faults. Their attitude in this matter is understandable, as there is always a natural reluctance to break connections that have been neatly, and perhaps painfully, soldered in place, particularly when they are rather inaccessible.

Unfortunately, there is generally no way out of the difficulty, as it is very often quite impossible to make a proper continuity or insulation test, because of the existence of a parallel path. The need for disconnection is particularly likely to arise when endeavouring to locate an anode circuit short-circuit in a set where a common feed through decoupling resistances is provided.

o o o o

INSULATED CONDENSER SPINDLES.

Except when dealing with the simplest type of receiver it is necessary to provide insulation between the variable condenser spindles and the screening cases or metal panels that are almost of necessity employed nowadays in the construction of sets with H.F. amplifiers or band-pass filters. This need arises because both sets of vanes must be at the same potential as the grid of the

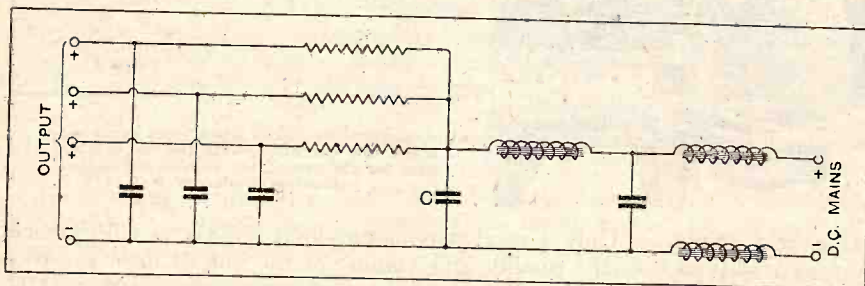

Fig. 1.—Where to add extra capacity to an eliminator with a view to reducing impedance of the smoothing circuits.

about by reducing the impedance of the smoothing chokes, as otherwise their efficacy in eliminating hum would be lowered. The practical way out of the difficulty is to increase the capacity shunted across the

by station over a wide section of the tuning scale, is, in a receiver using an S.G. high-frequency valve, often considered to be due to a somewhat obscure effect known as cross modulation, and is particularly difficult to

Hints and Tips.—

succeeding valve, as the condenser itself is invariably shunted by a tuning coil, and because it is almost universal practice nowadays to apply a biasing voltage to the grid. The metalwork is always earthed, and is also in metallic contact with the common negative bus-bar. As is shown in Fig. 2(A) a short-circuit will be introduced across the biasing battery if the tuning condenser is also earthed.

All this applies to conventional practice, but an exception exists in

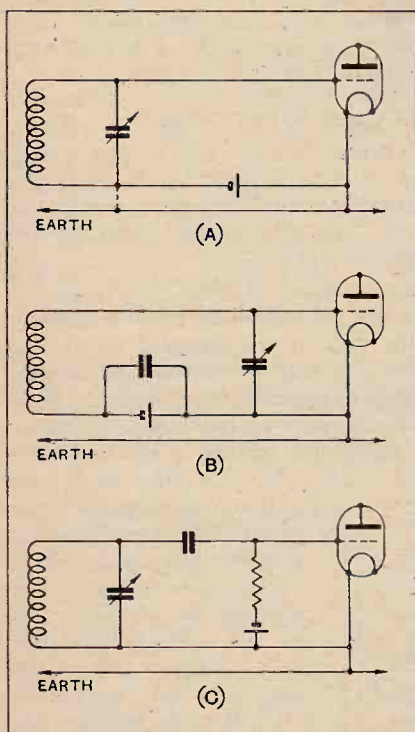

Fig. 2.—The dotted line in diagram A shows how a short circuit may be introduced across a grid-bias cell unless the tuning condenser plates are insulated from earthed metalwork. The remaining diagrams show methods of avoiding the need for this insulation.

the case of a grid circuit detector, where the necessary condenser ensures that the grid shall be insulated, except for potentials applied through the leak.

Although it might seem at first sight that there is little difficulty in providing the necessary insulation for the condenser fixing bush, it is not always convenient to do so, particularly when an experimental circuit is being set up, and accordingly it is useful to know that the need for

an insulated spindle may be overcome in several ways.

The most obvious arrangement is that shown in Fig. 2(B), where the bias battery is actually transferred from the grid return lead to the closed oscillatory circuit. This is quite a good plan, but may lead to slight losses in efficiency in a receiver where coils and circuits of exceptionally low loss are used. This is because a dry cell has in any case a certain resistance, and this resistance increases fairly rapidly with age, until it may have a value equal to, if not greater than, the H.F. resistance of the coil itself. The remedy is to shunt the battery with a large condenser, as shown.

As an alternative, a grid condenser can be interposed, the necessary bias being applied through a leak. This method is illustrated in Fig. 2(C). It has the disadvantage that the tuned circuit is shunted by a resistance which slightly lowers its efficiency. As a matter of fact, this loss need not be appreciable; a more serious drawback is attributable to the fact that an occasional overload may bring about grid rectification and choking.

Finally, it should be borne in mind that a few condensers—one is inclined to say unfortunately a very few—are available in which the necessary insulation is provided by the makers.

o o o o

REDUCING GRID DAMPING.

Although damping of the preceding circuit by a grid detector can be largely offset by the application of reaction, which is, almost as a matter of course, included when this form of rectification is used, it does not altogether follow that some other way of reducing loading would not on occasion be acceptable. The operation of a receiver in which, to attain both the necessary selectivity and sensitivity for the reception of distant stations, it is necessary to make almost continuous adjustments of the reaction control, is apt to be wearisome. It is particularly annoying to find that local station signals spread over almost the whole of the tuning scale unless the effective H.F. resistance of the tuned circuit is maintained at a reasonably low value by manipulation of a control

of which the setting varies with wavelength.

It is often possible to reduce one's dependence on reaction by "tapping down" the grid connection. The normal circuit arrangement is shown in Fig. 3(A), and the alteration that it is here recommended should be experimentally tried is illustrated in diagram B, from which it will be seen that instead of applying the total H.F. voltage developed across the circuit to the grid, only a fraction of it is so applied, depending upon the position of the tapping. As a rough and ready rule applicable to the average broadcast receiver, the grid circuit should be joined across approximately two-thirds of the total number of turns.

When no reaction is used it is generally possible to detect a distinct rise in rectified output, brought about by this alteration. When a milliammeter is available, it is not a difficult matter to determine by measurement the best position for the tapping. To do this, the meter is inserted in the detector anode circuit, and its reading noted with the normal form of connection after having tuned in a fairly strong signal. Experimental connections of the grid tap are then tried, and the one giving the greatest downward deflection from the "no signal" reading can be assumed to be best. It is essential that the circuit should be

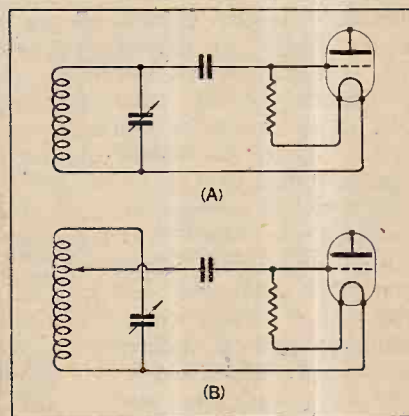

Fig. 3.—A conventional grid detector circuit, and (diagram B) the same arrangement modified to reduce damping.

retuned each time an alteration is made, and, of course, that all other conditions should remain unchanged.

WIRELESS THEORY SIMPLIFIED



By S. O. PEARSON,
Sc., A.M.I.E.E.

Part XXXIII.—High-frequency Resistance of Conductors.

(Continued from page 592 of the issue dated June 4th.)

THE unequal current distribution or skin effect in a conductor carrying an alternating current is only important in so far as it affects the resistance of the conductor, and therefore the extent to which skin effect occurs is expressed numerically as the fractional or percentage increase of resistance compared with the D.C. value. For sound copper conductors the ratio of A.C. to D.C. resistance depends upon the product of the diameter and the square root of the frequency. Thus with large diameters the skin effect may be quite appreciable even with frequencies as low as 50 cycles per second, whereas on the other hand, with very thin wires, the skin effect may be negligible even at radio frequencies.

The number k by which the D.C. resistance of a straight conductor has to be multiplied to give the A.C. resistance has been accurately worked out for various values of diameter $\times \sqrt{\text{frequency}}$, and the values of k are given by the curves of Fig. 1 over the range of diameter $\sqrt{\text{frequency}}$ likely to be encountered in normal receiving circuits. The largest size of wire used in such circuits is not likely to exceed No. 14 s.w.g., which has a diameter 0.203 cm., and at a frequency of 15×10^6 cycles per second (corresponding to a wavelength of 20 metres) the value of diameter $\sqrt{\text{frequency}}$ is 788. Thus from the curve we see that with a current whose frequency is 15 million cycles per second in a No. 14 s.w.g. wire, the resistance is nearly 30 times as great as the D.C. resistance! For a No. 18 s.w.g. copper wire the A.C. resistance at a frequency of 1,000 kc. (300 metres) is 4.8 times the D.C. resistance, whereas at the same frequency for a No. 42 s.w.g. wire the A.C. resistance is only about 3 per cent. in excess of the D.C. resistance. The multiplying factors given by the curves of Fig. 1

only apply to round straight conductors made from non-magnetic material such as copper. For iron wires the figure is very much higher.

Extreme Cases of Skin Effect.

Not only is the current density less in the depths of the conductor than at the surface, but there is also a phase difference between the surface currents and those near the centre. The thicker the conductor and the higher the frequency the greater is this phase difference, and for large values of diameter $\sqrt{\text{frequency}}$ the current at the centre may actually have a reversed phase compared with that at the surface, so that at any instant the current at the centre may be flowing in the opposite direction to that near the surface. Under such conditions the centre part of the conductor is not merely useless, but is actually adding to the resistance of the conductor as a whole. By removing the middle portion and thereby converting the solid conductor into a tube of the same external diameter having a wall of moderate thickness the resistance is actually decreased. For high-power work where radio frequencies are employed, e.g., in large transmitting stations, copper tubes are frequently used in preference to solid conductors, thereby effecting an increase in efficiency and a saving of material.

Another important aspect of skin effect is that which arises when a copper conductor has its surface coated with another metal. For instance, tinned copper wire is very widely used in the construction of receiving sets. Now, if the coating of tin is moderately thick the skin effect at very high frequencies may be sufficiently pronounced to force the major part of the current to flow in the tin coating in spite of the fact that tin has a higher resistivity than copper; the resistivity of tin is

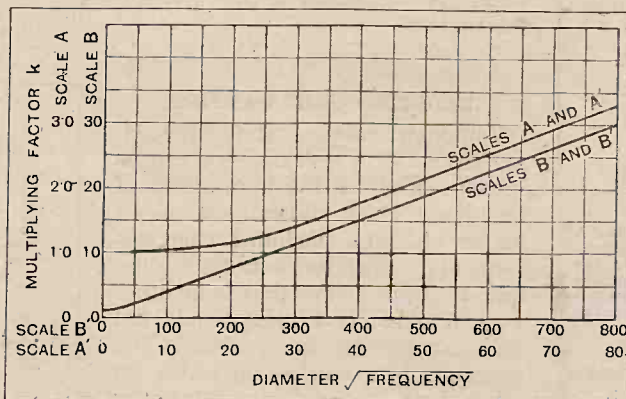

Fig. 1.—Curve enabling the H.F. resistance of round wires to be determined from the D.C. resistance. $R_{ac} = k R_{dc}$. The multiplying factor only applies to single straight conductors and not to a coil. The diameter is in centimetres and the frequency in cycles per second.

Wireless Theory Simplified.—

about 8.3 times as great as that of copper. There is thus a possible danger that by tinning a copper wire we may actually increase its high-frequency resistance. But, in practice, the thickness of tin on the surface of the conductor is so small that at all normal radio-frequencies the resulting increase of resistance is negligibly small.

Nickel plating is rather more serious in this respect as nickel is one of the magnetic materials, being attracted by a magnet, though not so strongly as iron.

Conductor Resistance of Single-layer Coils.

When a conductor carrying a current is brought into close proximity to one or more other such conductors

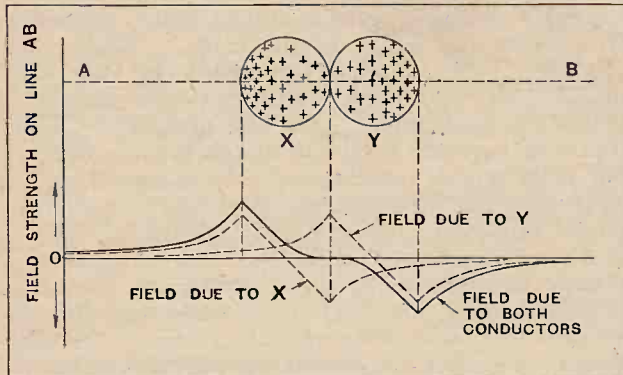

Fig. 2.—Two adjacent parallel conductors carrying equal direct currents would produce a field strength at points along the line AB as indicated by the curves. When an A.C. flows the field causes the current to concentrate on the remote sides of the conductors.

the magnetic field surrounding each is no longer circular in form, and therefore at high frequencies the current will not be distributed in the manner described for a single straight conductor. Instead of the tendency for the current to be displaced symmetrically towards the circumference of the conductor there are forces now tending to drive the current over to one side of the conductor only. For instance, if two conductors placed side by side carry the same high-frequency current, being connected in series, the current in each tends to concentrate on that side of each which is the more remote from the other, as shown by Fig. 2, the assumption being that the current in each is flowing in the same direction. This is sometimes called *proximity effect* to distinguish it from simple skin effect. (A cross, ×, denotes a current flowing away from the observer, the × representing the feathered end of an arrow viewed from behind, and a dot represents a current flowing towards the observer, or the point of an approaching arrow.) Where the crosses are closest together the current density is greatest.

It may be taken as a general rule that the high-frequency current tends to concentrate in that part of the conductor where the field strength is greatest, as was found to be the case with the single conductor. The full-line curve in the lower part of Fig. 2 represents the field-strength with uniform distribution of current in each of the two parallel conductors at all points along

the line AB passing through their centres. The broken-line curves give the field-strength due to the individual conductors X and Y carrying equal currents in the same direction, and the resultant full-line curve is obtained by adding together the two individual curves. It will be seen that the maximum field-strength occurs at the most widely separated points of the two conductors and that there is no field at the point midway between them.

In a single-layer tuning coil wound with solid round wire on a cylindrical former the magnetic field produced by a current in the coil is disposed somewhat as shown by the broken lines of Fig. 3. From this it is clear that a short length of any one turn is "immersed," not only in its own magnetic field, but also that due to all the remainder of the wire in the coil. The net result is that when a high-frequency current is flowing there is a concentration of the current in the parts of the wire which are nearest to the axis of the coil. Over and above the ordinary skin effect electromotive forces are induced in any one conductor by the magnetic field due to the rest, and these act in such a direction relative to the axis of the wire that, on the average, the current is driven inwards towards the axis of the coil.

Conductor Losses.

This redistribution of the current results in extra losses, and formulæ have been developed for calculating them to a considerable degree of accuracy. The total conductor losses in a coil can be considered as the sum of three separate sources of loss each of which can be calculated, namely (a), the ordinary loss due to the D.C. resistance of the conductor, (b) the extra loss due to simple skin effect as found for a straight conductor, and (c) the further losses resulting from the action of the magnetic field of the coil as a whole on the conductor.

Of these, (a) is constant for a given value of current, while (b) depends on the diameter of the wire and the frequency. Having found the D.C. resistance for the wire used, either from tables or by calculation from the resistivity, the effective resistance accounting for losses (a) and (b) combined can be determined with the aid of the curves of Fig. 1. The loss (c) depends not only on the diameter of wire and the frequency, but also on the dimensions and shape of the coil and the spacing of the turns.

When the turns of a coil are very close together the losses due to "proximity effect" become appreciable. With a coil of specified dimensions having a definite number of turns, as is usually the case in practice, the pitch of the winding is fixed, that is to say, the distance between the centres of any two adjacent wires has a predetermined value. It used to be common practice to wind coils with the largest size of insulated

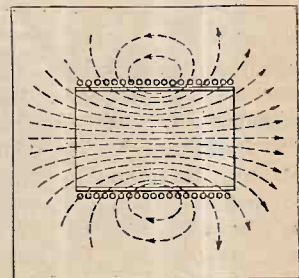

Fig. 3.—Diagram showing the nature of the magnetic field produced by a cylindrical coil. High-frequency currents are crowded into the part of the wire nearest the former. Spacing the turns reduces losses.

Wireless Theory Simplified.—

wire that could be got into the available winding space with the insulation of adjacent turns touching, the assumption being that the larger the diameter of the wire the lower would be the high-frequency conductor resistance of the coil. But in 1925 and 1926 the high-frequency resistance of tuning coils was very completely analysed by S. Butterworth,¹ of the National Physical Laboratory, who showed that for a given number of turns per centimetre there is a particular size of wire for which the H.F. conductor resistance is a minimum at a given frequency for a coil of specified ratio of length to diameter.

A coil wound with wire of the maximum diameter, so that the turns touch, will have a definite effective conductor resistance depending on the frequency of the current. If now the coil is rewound with wire of slightly smaller diameter, but with the same number of turns occupying the same winding length, the losses due to proximity effect and skin effect will be reduced to a greater extent than the increase due to the higher D.C. resistance of the smaller wire, so that on the whole the effective resistance of the conductor is actually reduced. If the process is repeated with diminishing diameters of wire an optimum diameter will be reached below which any further diminution will cause the losses due to D.C. resistance to increase at a greater rate than the reduction of the losses due to skin and proximity effects. Thus there is a particular size of wire which will make the high-frequency resistance a minimum. Practical instructions regarding the design of tuning coils on these lines were given in detail in *The Wireless World* of December 8th and 15th, 1926.

Methods of Reducing Skin Effect.

Although increasing the gap between adjacent turns by reducing the diameter of the wire and keeping the pitch of the winding constant does reduce the losses due to high-frequency effects in the conductor, it simultaneously causes the losses due to the ordinary D.C. resistance of the conductor to be increased. It is natural, therefore, to consider means whereby the high-frequency effects (skin effect and proximity effect) might be reduced without any appreciable increase in the D.C. resistance. The latter depends alone on the effective cross-sectional area, and therefore this area of section should not be reduced unless unavoidable.

Now, since the skin effect at a given frequency is less pronounced in a thin wire than in a thick one, it would appear reasonable to suppose that if the solid wire were replaced by one composed of a number of strands of thin wire all insulated from each other except at the ends, and having an aggregate cross-sectional area of copper equal to that of the original solid conductor, the high-frequency losses would be reduced without increasing the D.C. resistance. This, however, is only true provided the wire is stranded in a special manner. For instance, an ordinary stranded cable where the strands are simply twisted together does not give the desired result even though each strand is insulated from the rest. This is because any one strand is at the

same distance from the centre of the cable throughout its length; the central strand, for example, occupies that position from beginning to end of the cable.

When an alternating current is flowing through such a cable, the portion of the current in the central strands produces a magnetic field which generates E.M.F.s in the outlying strands and increases the current in them at the expense of those near the centre. Thus, with an ordinary twisted cable, skin effect will be present to almost the same extent as in a solid conductor.

Litzendraht.

It will be clear, then, that in order to reduce the skin effect by the use of stranded wire the strands will have to be interwoven in such a way that each individual strand passes from the centre to the outside of the cable and back again at regular space intervals as it traverses the length of the cable. Under these conditions each strand is surrounded by the same magnetic flux and therefore each carries the same fraction of the total current. The best method of effecting this is to have the insulated strands braided together, but as the process is rather expensive a simpler method of twisting the wires together in groups is more commonly employed. Three strands are twisted together in the ordinary way, then three of these composite conductors each containing three strands are themselves twisted together, resulting in a conductor with nine strands. Continuing the process, three of the nine-strand conductors are twisted together, and so on.

High-frequency cable which is built up in this way is known as "Litzendraht," the word being usually abbreviated to "Litz." A very common "size" of Litz used for winding efficient tuning coils for the medium band of broadcast wavelengths is that made up of 27 strands of No. 42 s.w.g. single silk-covered wire.

Litzendraht is necessarily very expensive compared with a solid wire of the same sectional area. If the individual strands are enamelled instead of being silk covered the cost is less, but, in general, the silk-covered variety is more reliable.

For the best results it is essential that every strand shall be without a break—a strand with a break in it is useless in the cable as it carries no current. The measured D.C. resistance of a length of Litz wire should therefore agree with the calculated value based on the resistivity of the copper; if there are n strands the D.C. resistance of the cable as a whole must be approximately $\frac{1}{n}$ of the resistance of one strand.

In joining up a Litz wire to a terminal it is essential that every strand should have its end cleaned and soldered to the terminal strip.

It will be realised, of course, that even the stranding of the wire in the proper manner will not entirely eliminate skin effect because each individual strand will have a certain amount of skin effect of its own, but on account of the small diameter this will occur to a small extent only. The larger the number of strands and the smaller their diameter the lower will be the H.F. resistance of the resulting composite conductor—and the more expensive.

(To be continued.)

¹ *Experimental Wireless*, April to August, 1926.

BROADCAST



BREVITIES

By Our Special Correspondent.

That "Wireless Link."—Cathedral Microphone Problem.—Broadcasting Drama on Sunday.

Plans for Northern Regional Tests.

Although the station buildings at Moor-side Edge are not yet completed, plans are already in preparation for the first Northern Regional transmission tests towards the end of the year. The probability is that the Brookmans Park precedent will be copied, i.e., the first tests will be given on the higher wavelength (479.2 metres), to be followed a few weeks later by National transmissions on 376 metres.

o o o o

Abolishing the Wireless Link.

Northern listeners are hoping that the development of the Regional Scheme will spell the doom of the wireless link, one of the most makeshift devices in the history of radio.

Besides suffering interference from atmospheric, those who listen to the provincial stations before 5 p.m. are often subject to interruptions by Post Office wireless stations, in addition to those other extraneous noises which seem inevitable in distant reception.

o o o o

Broadcasting from St. Paul's.

The wireless link will be extensively used on June 25th, when the Thanksgiving Service in St. Paul's Cathedral is relayed from Brookmans Park, probably by the National transmitter. One hesitates to imagine what sort of sounds will emerge from the loud speakers of Aberdeen.

o o o o

A Microphone Problem.

I spent half an hour in the Cathedral a few days ago while the microphone tests were in progress. The engineers fear that satisfying results can be secured only if the "mikes" are slung from pillar to pillar as in the Queen's Hall and other buildings, but I understand that the ecclesiastical authorities would prefer to have all the wireless gear concealed.

o o o o

A Mistaken Notion.

Let us hope that the Dean and Chapter will come to the conclusion, which most of us share, that the ordinary Reisz microphone is quite a handsome little instrument. Few people notice it, and I have met only one man who thought the suspended object was the skull of a cat or other small mammal.

A 25

America Clamours for British Broadcasting.

Savoy Hill is rightly flattered by the rivalry which has sprung up in America to secure the B.B.C. programmes. Since the recent announcement that the Columbia system had come to an arrangement for the exchange of programmes with the B.B.C., the rival American organisation—the National Broadcasting Company—has lost no time in proclaiming forthcoming "hours" devoted to the reception of British programmes.

But I understand that neither Columbia nor N.B.C. are tapping the B.B.C. on Sundays. Why, oh why?

A Broadcast Drama . . . on Sunday!

Talking of the Sunday programmes, I am rather startled by the news that the B.B.C. actually intends to broadcast a drama on Sunday, June 29th. The work in question is Walter de la Mare's play, "Yes, and Back Again," which will be given from the National transmitter during the 9.30 to 10.30 period.

Are we at the beginning of a new era in Sabbath broadcasting, or has someone

blundered? Anyway, it would be gracious on the part of listeners to accept the innovation with gratitude and hope.

o o o o

Successful Musical Experiment.

Despite the dismal failure, from the box office viewpoint, of their concerts in the Queen's Hall, the B.B.C. have the gratification of knowing that the Northern "Proms" experiment has been a huge success. During the fortnight at Manchester, the Hallé Orchestra under Sir Hamilton Harty have drawn over 20,000 people.

The "North" is often regarded as being more musical than the "South," and these figures help to prove it, though it is worth remembering that the London "Proms" in the Autumn are usually well attended.

o o o o

H.M. The King to Broadcast.

For the first time since his illness, the King will be heard at the microphone on July 8th, when His Majesty opens the new India House on the Bush House site, Aldwych, W.C. The microphone will be situated in the library, where the ceremony will take place. Many Indian princes are expected to attend.

o o o o

British Museum to the Rescue.

The British Museum sometimes plays an important and useful part in connection with projected broadcasts. On one occasion it was desired to broadcast a real Australian Aboriginal song, but letters to Australia brought negative replies. An appeal was made to the British Museum, and the B.B.C. got what it wanted.

Again the authorities have come to the rescue, this time in connection with the Paganini programme from Belfast on Monday last, June 16th. On writing to publishers in England, France, and Italy, no trace of the aria, "Mi vien da ridere," could be found. But the Museum "delivered the goods."

o o o o

In a Ship's Engine Room.

Lieut.-Commander J. H. Caine will broadcast a running commentary on the departure on her maiden voyage of the m.v. *Britannic* from Liverpool on June 28th. The broadcast will include visits to the engine room, the purser's office, and the bridge.



STRAIGHT FROM THE "HORSE'S" MOUTH. Through the enterprise of the broadcasting authorities, German listeners recently enjoyed a first-hand account of the ~~sound~~ Germany cycle race given by the winner on his arrival at the stadium.

READERS' PROBLEMS.

"The Wireless World" Supplies a Free Service of Technical Information.

The Service is subject to the rules of the Department, which are printed below; these must be strictly enforced, in the interest of readers themselves. A selection of queries of general interest is dealt with below, in some cases at greater length than would be possible in a letter.

H.F. Couplings Compared.

I am undecided as to whether to choose tuned grid or tuned anode H.F. amplification for my projected new receiver. Do you think that the extra amplification afforded by the tuned grid method is worth the extra expense involved? F. S.

In the first place, we would point out that you are wrong in thinking that the "parallel feed" or "tuned grid" method of H.F. amplification affords greater amplification than a tuned anode coupling; actually, it is slightly less sensitive. It is, however, a very real advantage when it precedes a detector valve. L.F. impulses due to voltages set up across common impedances or resistances cannot be passed back via the tuned grid coil to the detector grid; this circuit is virtually "shorted" by the tuning coil as far as anything but H.F. currents are concerned.

Rectifier for the Modified "Foreign Listeners' Four."

With reference to the diagram on page 557 of your issue for May 28th, in which a modified circuit of the "New Foreign Listener's Four" was given, will you please tell me what type of rectifier valve would be necessary for supplying this set?

I take it that the rectifier H.T. supply would merely be joined to the H.T. terminals shown? T. F. R.

As an additional amount of energy has to be dissipated in the biasing field winding, it is necessary to use for this arrangement a high-power rectifying valve; a Marconi or Osram U.8 would be suitable.

You are correct in assuming that the output of the rectifier will be fed direct to the H.T. terminals indicated in the circuit diagram: smoothing arrangements are included in the receiver itself.

asuring Pick-up Voltage.

In your recently published reviews of commercial pick-ups, a definite figure is given for voltage output at various frequencies. Will you tell me what sort of instrument is used for this measurement? C. G.

To make measurements of this kind, under working conditions—which implies that the pick-up will be operated under "no load" conditions—it is essential to use a valve voltmeter which, in simple terms, is a valve detector with a meter in its anode circuit. Instruments of this kind are more or less independent of frequency, and impose a load that, to all intents and purposes, is entirely negligible.

Shocks from D.C. Mains.

I have just installed an H.T. eliminator (D.C. mains), and find that a shock is obtained on touching the grub screws which secure the condenser dials to their spindles. Does this prove that the positive wire of my mains supply is earthed? What can be done to avoid those shocks? R. N. S.

Assuming that your receiver is working properly, and that there is no serious short-circuit, it would appear certain that the positive side of your supply is earthed.

In most cases there is no practical way of tying down the condenser spindles to earth potential in order to avoid shocks, but we suggest that it should be fairly easy to overcome the trouble by shortening the grub screws.

Power Transformer Regulation.

I have an L.T. power transformer rated as being capable of delivering 4 amps. at 4 volts: do you think it would be safe to use it for supplying the filament of a single Osram P.X.4 valve? Under these conditions the load will amount to no more than 0.6 amp., which is very much less than that for which the transformer was designed, and I am afraid that there may be an undue rise in voltage. T. W. E.

As compared with the voltage existing when the transformer is used with a more normal load, there is no doubt that there will be some rise when the current consumed is no more than 0.6 amp. As to the extent of this rise, we can give no definite information, as everything depends on the basis on which the trans-

RULES.

(1.) A query must be accompanied by a COUPON removed from the advertisement pages of the CURRENT ISSUE.

(2.) Only one question (which must deal with a single specific point) can be answered. Letters must be concisely worded and headed "Information Department."

(3.) Queries must be written on one side of the paper and diagrams drawn on a separate sheet. A self-addressed stamped envelope must be enclosed for postal reply.

(4.) Designs or circuit diagrams for complete receivers or eliminators cannot ordinarily be given; under present-day conditions justice cannot be done to questions of this kind in the course of a letter.

(5.) Practical wiring plans cannot be supplied or considered.

(6.) Designs for components such as L.F. chokes, power transformers, complex coil assemblies, etc., cannot be supplied.

(7.) Queries arising from the construction or operation of receivers must be confined to constructional sets described in "The Wireless World," to standard manufactured receivers; or to "K" sets that have been reviewed.

former is designed; we suggest that you should apply to its makers for information.

If the transformer regulation is poor, it is quite possible that its voltage output on a light load will be sufficiently high to bring about some reduction in the life of the valve.

Separate Winding Unnecessary.

I am about to make a receiver on the lines of "The Wireless World" Kit Set, but from motives of economy, and due to the fact that high selectivity is not essential in this neighbourhood, it is proposed to eliminate the separately tuned aerial circuit. Will it be necessary to add aerial coupling coils to the existing medium- and long-wave grid inductances? If so, will you give me the correct number of turns? W. G. T.

It is by no means necessary to provide separate "aperiodic" aerial coupling coils, and we suggest that you should use a simple auto-transformer arrangement. To do this, tappings should be made at about the twelfth turn from the earthed end of the medium-wave grid coil, and at about the thirty-fifth turn on the corresponding long-wave winding.

Insufficient Primary Impedance.

As I wish to obtain the maximum possible L.F. magnification, would it be possible to use a Ferranti 7:1 ratio transformer in the construction of a receiver on the lines of the "New Kilo-Mag Four"? I believe that this transformer is intended especially for receivers with a single L.F. stage.

C. G. E.

You are right enough in assuming that this 7:1 transformer is intended for use in sets where the detector feeds direct into the output valve, but it should be made quite clear that it is not designed for insertion in the anode circuit of a bottom-bend detector, and so it would be unsuitable for a receiver like the "Kilo-Mag Four."

"Electrification by Installments."

Following a suggestion made under the above heading in your issue of April 9th, I have fitted an A.C. power transformer for the output valve of my receiver, the remaining L.T. current being provided by a small accumulator. The arrangement works well, but there is a very slight trace of "hum," which I should like, if possible, to eliminate altogether. Any advice that you can offer would be welcomed.

N. M. S.

It is, we fear, most difficult entirely to eliminate all traces of hum when an arrangement of this kind is used, particularly if the output valve has a fairly thin filament with a low current consumption.

If your filament-heating transformer has a centre tap, it might be of advantage to fit a low-resistance potentiometer across it, in order that an artificial electrical centre may be more accurately located. Alternatively, of course, you could replace the valve with one having a thicker filament.

A HIGHER CONDUCTANCE MUTUAL ANY OTHER BATTERY. HEATED POWER VALVE THAN



**P. 240
PRICE
15/-**

*With Mazda valves
in all positions your
set will give a per-
formance many times
better than before.*

The Amazing

MAZDA RADIO VALVES

For a given type of valve the higher its amplification factor and the lower its impedance the better the performance which can be expected of it. The Mazda P.240 has the highest magnification factor for its impedance of any 2-volt power valve. This quality is expressed as mutual conductance and the higher the mutual conductance figures the better the valve.

It can therefore be truthfully claimed that the P.240 is the finest 2-volt power valve on the market—without exception.

THESE FIGURES PROVE IT . . .

Amplification Factor	- - - -	7
Anode A.C. Resistance (ohms)	- -	1,900
Mutual A.C. Conductance (MA/V)	-	3.7



THE EDISON SWAN ELECTRIC CO., LTD.,
Radio Division,
1a, Newman Street, Oxford Street, W.1.
Showrooms in all the Principal Towns.

EDISWAN

7.51.

MISCELLANEOUS ADVERTISEMENTS.

NOTICES.

THE CHARGE FOR ADVERTISEMENTS in these columns is:

12 words or less, 2/- and 2d. for every additional word.

Each paragraph is charged separately and name and address must be counted.

SERIES DISCOUNTS are allowed to Trade Advertisers as follows on orders for consecutive insertions, provided a contract is placed in advance, and in the absence of fresh instructions the entire "copy" is repeated from the previous issue: 13 consecutive insertions 5%; 26 consecutive, 10%; 52 consecutive, 15%.

ADVERTISEMENTS for these columns are accepted up to FIRST POST ON THURSDAY MORNING (previous to date of issue) at the Head Offices of "The Wireless World," Dorset House, Tudor Street, London, E.C.4, or on WEDNESDAY MORNING at the Branch Offices, 19, Hertford Street, Coventry; Guildhall Buildings, Navigation Street, Birmingham; 280, Deansgate, Manchester; 101, St. Vincent Street, Glasgow, C.2.

Advertisements that arrive too late for a particular issue will automatically be inserted in the following issue unless accompanied by instructions to the contrary. All advertisements in this section must be strictly prepaid.

The proprietors retain the right to refuse or withdraw advertisements at their discretion.

Postal Orders and Cheques sent in payment for advertisements should be made payable to ILIFFE & SONS Ltd., and crossed & Co. Notes being untraceable if lost in transit should not be sent as remittances.

All letters relating to advertisements should quote the number which is printed at the end of each advertisement, and the date of the issue in which it appeared.

The proprietors are not responsible for clerical or printers' errors, although every care is taken to avoid mistakes.

NUMBERED ADDRESSES.

For the convenience of private advertisers, letters may be addressed to numbers at "The Wireless World" Office. When this is desired, the sum of 6d. to defray the cost of registration and to cover postage on replies must be added to the advertisement charge, which must include the words Box 000, c/o "The Wireless World." Only the number will appear in the advertisement. All replies should be addressed No. 000, c/o "The Wireless World," Dorset House, Tudor Street, London, E.C.4. Readers who reply to Box No. advertisements are warned against sending remittance through the post except in registered envelopes; in all such cases the use of the Deposit System is recommended, and the envelope should be clearly marked "Deposit Department."

THE DEPOSIT SYSTEM.

Readers who hesitate to send money to unknown persons may deal in perfect safety by availing themselves of our Deposit System. If the money be deposited with "The Wireless World," both parties are advised of its receipt.

The time allowed for decision is three days, counting from receipt of goods, after which period, if buyer decides not to retain goods, they must be returned to sender. If a sale is effected, buyer instructs us to remit amount to seller, but if not, seller instructs us to return amount to depositor. Carriage is paid by the buyer, but in the event of no sale, and subject to there being no different arrangement between buyer and seller, each pays carriage one way. The seller takes the risk of loss or damage in transit, for which we take no responsibility. For all transactions up to £10, a deposit fee of 1/- is charged; on transactions over £10 and under £50, the fee is 2/6; over £50, 5/-. All deposit matters are dealt with at Dorset House, Tudor Street, London, E.C.4, and cheques and money orders should be made payable to Iliffe & Sons Limited.

SPECIAL NOTE.—Readers who reply to advertisements and receive no answer to their enquiries are requested to regard the silence as an indication that the goods advertised have already been disposed of. Advertisers often receive so many enquiries that it is quite impossible to reply to each one by post.

"WIRELESS WORLD" INFORMATION COUPON

This Coupon must accompany any Question sent in before

JUNE 25th, 1930

For Particulars of Free Service, see Rules on page 658.

Mention of "The Wireless World," when writing to advertisers, will ensure prompt attention.

METAL CABINETS

Electrically sealed

Complete with Base for 1930 Everyman Four, New Kilomag Four, and W.W. Record III. Jacobean Finish.

TERMS: CASH WITH ORDER Price 57/6.

RIGBY & WOOLFENDEN, SHEET METAL WORKERS, MILNROW RD., ROCHDALE.

SEND TO-DAY FOR OUR FREE 36-PAGE BOOKLET "SOUND ADVICE."



Super Power Moving Coil Speaker.

The Finest High-grade Speaker in the World

PERFECT RECEPTION FOR MUSIC LOVERS

BAKER'S 'Selhurst' RADIO

Offices: 89, Selhurst Rd., S. Norwood, S.E.25. Works: 42, Cherry Orchard Rd., E. Croydon.

WANTED.

A satisfactory means of obtaining new radio material with economy by owner of valuable but unwanted radio apparatus. The means must be without trouble or risk, and must provide a good allowance for his unwanted material, and must also provide, if required, for delivery in various parts of the world. (Recommended to utilise the service of APPLEBY'S, Chapel Street, Marylebone, London, the first and largest radio part exchange service. Particulars upon application.)

BONA FIDE TRADERS' GUIDE.

Send for our comprehensive Illustrated List. QUICK SERVICE. QUICK SERVICE.

THE QUALITY HOUSE.

PERSEUS MFG. CO., LTD. (Dept. W.W.). BRANSTONE RD., BURTON-ON-TRENT.

METAL CABINETS

for all Wireless World sets from 22/6.

Aluminium screening boxes, all sizes, to order. Standard size from stock, 6x6x6 1/2, price 4/- each.

W. H. PARKER, Sheetmetal Workers, Back Autumn Terrace, Leeds Tel. 52859.

SPECIFIED for the

YACHTSMAN'S SET

TWO 0005, No. 3 "POLAR" Drum Control Condensers.

WINGROVE & ROGERS Ltd. 188-9, Strand, London, W.C.2



POLAR

ELEX

TREBLE DUTY TERMINALS

in 6 colours, and 40 indicating tops, red and black. Hold securely spade, pin, eye or plain wires. (T2LC) 4/4 each. (T2LM) plain top, 3d. each. Write for list X104.

J. J. EASTICK & SONS, Elex House, 118 Bunhill Row, London, E.C.1



RECEIVERS FOR SALE.

SCOTT SESSIONS and Co., Great Britain's Radio Doctors.—Read advertisement under Miscellaneous.

HIRE a McMichael Portable Set, by day or week, from Alexander Black, Wireless Doctor and Consultant, 55, Ebury St., S.W.1. Sloane 1655. [0328]

PHOENIX Master 3-star Kits, complete with cabinet, £2/2; ditto, with valves, £2/17/6; ditto, with H.T. and L.T. batteries and speaker, £4/5.—Phoenix, 314, High Rd., Lee, S.E.13. [9704]

PHILIPS All-mains Four, very latest model, £25; Celestion C.Z.20, £5; whole outfit only 3 weeks old and cost £46/5; seen any time.—Turner, 13, Elgin Av., Maida Vale, W.9. [9715]

PETO-SCOTT Solodyne (5-valve), perfect; £6; exchange portable.—2, Dollis Hill Av., Cricklewood, London, N.W.2. [9718]

FOR Sale, modern Foreign Listener's Four, including valves and royalties, unused, beautifully constructed; £25; appointment.—39, Bloomfield Terrace, S.W. [9721]

McMICHAEL Superhet, 6 valves, frame aerial, speaker; £9/10.—Mitchell, 31, Holloway Rd. [9734]

ELSTREE Six, built exactly to specification, with 6v. accumulator, trickle charger, eliminator, now in use, cost £42, owner going abroad, £10/10 for quick sale.—Featherstone, Deardens, Roscoe St., Scarborough. [9729]

FOR Sale, McMichael portable set, latest model, £18; reasonable offer.—Lyon, Holmeland, Aughton, Ormskirk, Lancs. [9723]

THERE is No Better Method of Purchase than Purchase by Part Exchange Through a Service Properly Conducted; it will be definitely to your advantage to utilise the radio part exchange and banking facilities offered in the name of Appleby; thousands of your fellow readers do, and have done for years; part exchange credit notes worth thousands of pounds have been duly honoured upon presentation; not a single item of customers' property has ever been lost or mislaid.—Particulars of this part exchange service, the first and largest in existence, will be forwarded upon request to The Secretary, Appleby's, Chapel St., Marylebone, London. [0558]

BERCLIF D.C.2 All Mains Receiver, 200 to 250 volts D.C.; price £14/10; with valves and royalties, suitable for M.C. speaker; particulars free; trade inquiries specially invited.—Simmonds Bros., Shireland Rd., Smethwick. [8734]

YOUR Old Receiver or Components Taken in Part Exchange for New; write to us before purchasing elsewhere, and obtain expert advice from wireless engineer of 25 years' professional wireless experience; send a list of components or the components themselves, and we will quote you by return post; thousands of satisfied clients.—Scientific Development Co., 57, Guildhall St., Preston. [0226]

TWO Transportable Wireless, including linen speakers, one new; £9/10 and £5.—Bertram, Great Bentley, Essex. [9754]

F. W. SMURTHWAITE, A.M.I.R.E., for better wireless, specialist in the design and construction of individual apparatus; whatever your requirements, may I suggest that you get into touch with me? My unbiased advice and quotations are available without obligation.

"WIRELESS World" Receivers; keen quotations for any design published in the "W.W." All sets beautifully made up to scientific instrument standard and guaranteed for 12 months.

HIGH Power Amplifiers, etc., all mains operated, up to 10,000 milliwatts speech output; details with pleasure.

OVERSEAS Readers—I have short wave receivers working in most parts of the world, and can supply unique instruments based on years of experience; as an example of good value take the R.S.G.B. 4-valve S/W receiver, complete with set coils and all valves, packed and delivered f.o.b., £25.

RECONSTRUCTIONS, etc.—I am now able to undertake reconstructions, repairs, etc.; sets converted to all mains operation, etc.; let me quote you; no work undertaken unless I am satisfied that a first class job will result, on which I can give a guarantee.

F. W. SMURTHWAITE, A.M.I.R.E., for better wireless; contractors to Boards of Guardians, the B.B.C., etc.—Enquiries to 15a, Onslow Gardens, Wallington, Surrey. Phone: Wallington 1982. [9750]

5-VALVE Marconi, 2 S.G. det. 2 L.F., handsome oak cabinet, cupboards for batteries, etc., L.F. valves want renewing, otherwise perfect; £5, or near offer.—Gover, 32, Effra Rd., Wimbledon, S.W.19. [9746]

REGENTONE Portable Unit, 100 volt input; £3, near offer.—Nickless, Bull Lane, Rayleigh. [9745]

A.C. All Mains 3-valve S.G., with speaker, £12; also milliammeters, microammeter, voltmeters, I.S.5a; L.S.5a; cheap.—Bennett, 90, Connor Rd., Dagenham. [9742]

Receivers for Sale.—Contd.

PHILIPS All Mains 3-valve A.C. Receiver, £15/10, 2 months' old, as new; also 2-valve, same make, £8/10; also Burgoyne 5-valve portable, cost £19/19, for quick sale £6.—"Pomfrets," Hawes Lane, West Wickham, Kent. [9743]

ACCUMULATORS—BATTERIES.

WET H.T. Replacements.—Sacs (capped or uncapped), highest grade, No. 1 10d. per doz.; No. 2, 1/9 per doz.—See below.

ZINCS—Best quality (wired), No. 1, 8d. per doz.; No. 2, 9d. per doz.; orders valued 5/- carriage paid, otherwise 6d. for postage.—British Battery Co., Clarendon Rd., Watford, Herts. [0258]

BARGAIN—5 24-volt units, Exide high tension accumulators, in good condition; all at 40/- cash.—Pidgeon, Riversdale, Queen's Av., King's Lynn. [9737]

ACCUMULATOR HIRE.

DON'T Buy Accumulators or Dry Batteries, join our C.A.V. low- and high-tension accumulator hire service, the largest and best in London; better and cheaper reception with no trouble; regular deliveries within 12 miles of Charing Cross; no deposit, payment on each delivery or by quarterly subscription; over 10,000 satisfied users; explanatory folder post free; phone or write to-day.—Radio Service (London), Ltd., 105, Torriano Av., N.W.5. Phone: North 0623-4-5. [8751]

CHARGERS AND ELIMINATORS.

CHEBROS—Chebros for all types of transformers and chokes, high grade instruments at a very moderate price; enquiries invited.—Chester Bros., 244 Dalston Lane, London, E.8. [5290]

PHILIPSON'S Safety High Tension Supply Units for A.C. and D.C. Mains, 200-250 volts 40-60 cycles, also 230 volts 25 cycles.

10/- Down and Small Monthly Payments Secures the Finest H.T. Supply Available.

PHILIPSON'S Safety H.T. Units are Guaranteed for 12 Months Against All Defects.

ALL Models Sold on 7 Days' Approval to Ensure Complete Satisfaction.

PHILIPSON'S Safety H.T. Units are the Cheapest to Install and the Cheapest to Run; £1/17/6 to £6.

WRITE for Our Booklet "Radio Power," which gives illustrations and full particulars.

PHILIPSON'S Safety Loud Speaker Output Filters for All Receivers, power valve, or Pentode; a remarkable output filter at a very low price; 16/6.

PHILIPSON and Co., Ltd., Radio Engineers, Astley Bridge, Bolton. Phone: 2038 Bolton. [0318]

MARCONIPHONE, all power unit, model D.C.1, for 110 volts D.C., as new; £3/3, bargain.—Knights, Harleston, Norfolk. [9709]

TANTALUM and Liumion for A.C. Rectifiers; for inexpensive chargers; blue prints for H.T. and L.T., 1/- each; Liumium electrodes, 2-3 and 5-8 amps.—Blackwells Metallurgical Works, Ltd., Garston, Liverpool. [8298]

POST Free Bargains—Approval, guaranteed, shrouded ironcore smoothing chokes, 500 ohm, 20 ma., 2/-; ditto windings, tapped, gapped, 0-300-500 ohms, 5/-; multi panel 4-pole lever change-over switches, 1/-.—Oliver, 325, Kennington Rd., London. [9714]

SAVAGE'S Specialise in Wireless Power from the Mains; reliable apparatus at reasonable prices.

SAVAGE'S—Transformer laminations and Bakelite bobbins; intending home constructors should write for list.

SAVAGE'S—Reliable smoothing condensers, 1,500 volt D.C. test, 1 mfd., 2/-; 2 mfd., 3/-; 4 mfd., 5/3; 500 volt D.C. test, 1 mfd., 1/6; 2 mfd., 2/3; 4 mfd., 3/9.

SAVAGE'S—Super smoothing and output chokes, many types available; write for list.

SAVAGE'S—Mains transformer for Westinghouse H.T.4 unit, with additional winding, 4 volts centre tapped 3 amps, 23/-; transformers for other Westinghouse units available.

SAVAGE'S—Mains equipment for new Foreign Listeners Four, transformer N.F.L.4, 33/-; smoothing choke, C32G, 20/-; output choke C32O, 20/-.

SAVAGE'S—Mains equipment for Power Pentode Two transformer, P.P.2, 33/-; output choke, L.C. 36P.G., 19/6; smoothing choke, L.C.36G, 18/-.

SAVAGE'S—Mains transformer B.T.4, 500-0-500 volts, 120 m. amps, 7½ volts 3 amps., 6 volts 3 amps., 4 volts 2 amps., 4 volts 1 amp., 4 volts 1 amp., all centre tapped, specially developed for automatic bias; 57/6.

SAVAGE'S—Mains transformers and power chokes are carefully and individually constructed from first class materials, with an exceptionally generous margin of safety.

SAVAGE'S, 146, Bishopsgate, London, E.C.2. Phone: Bishopsgate 6998. [9165]

MULLARD Eliminator, 105-volt mains, nearly new; sacrifice, £2 5s.—B. V., 10, Parsifal Rd., Hampstead, N.W.6. [9752]

INEXPENSIVE
**PUBLIC ADDRESS,
BAND REPEATER,**
and
**GRAMOPHONE RECORDING
— MICROPHONE —**

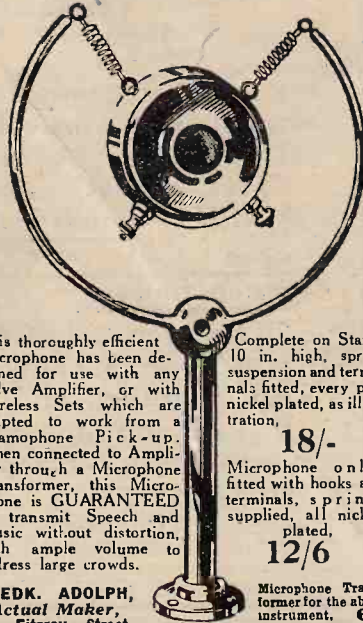

This thoroughly efficient Microphone has been designed for use with any Valve Amplifier, or with Wireless Sets which are adapted to work from a Gramophone Pick-up. When connected to Amplifier through a Microphone Transformer, this Microphone is GUARANTEED to transmit Speech and Music without distortion, with ample volume to address large crowds.

Complete on Stand, 10 in. high, spring suspension and terminals fitted, every part nickel plated, as illustration, **18/-**
Microphone only, fitted with books and terminals, springs supplied, all nickel plated, **12/6**

FREDK. ADOLPH, Actual Maker, 27, Fitzroy Street, LONDON, W.1. Microphone Transformer for the above instrument, 6/-
PHONE: Museum 8329

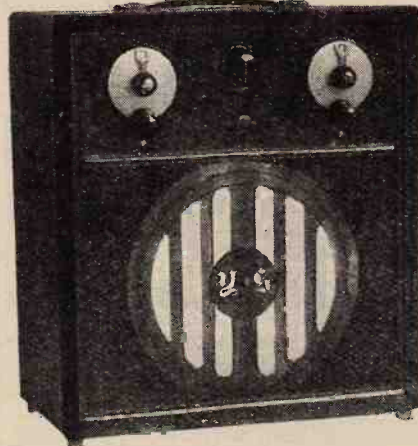

20 Guineas.
3-Valve All-Electric
Transportable, complete with built-in Loud Speaker. Entirely self contained.

Dual-wave range. Variable selectivity for all conditions of service. Universal Mains Transformer for 200-220-240 A.C. 50 Cycles. Mazda Mains Valves S.G., D., and Super Power. Parmeko Mains Equipment. Height 15½". Width 14½". Depth 7½". Weight 25 lbs.

YATES SUTTON LIMITED,
38-42, YORK STREET, LEICESTER.

Chargers and Eliminators.—Contd.

LOW Tension Eliminator, A.C., 2, 4, 6v., very perfect, guaranteed; 55/-.—Barrington, 186, James's Rd., Croydon. [9759]

SAVAGE Transformers and Chokes.

STOCKTAKING—The following new transformers are for sale owing to alteration of models: 22T20, 14T21, 12T22, and 5T23; also 34G and C28G chokes, all by Savage, of Bishopsgate.—Apply to Faraday, 8, Bridewell Place, Ludgate Circus, E.C.4. [9731]

TWO C.A.V. 66-volt Accumulators, Oldham H.T. charger, 240-volt A.C., almost new; bargain, £3.—21, Randall Av., N.W.2. [9715]

BURNDEPT No. 1223 Automatically Operated All-battery A.C. Eliminator; £4/10.—Badman, 12, Southside, Weston-super-Mare. [9727]

CABINETS.

DIGBY'S Cabinets.—Table models in solid oak and mahogany, from 11/6 to 71/-.

DIGBY'S Cabinets, fitted with Radion or Resiston ebonite if required.

DIGBY'S Cabinets.—Pedestal model, with separate battery components; from 56/- to £12.

DIGBY'S Cabinets Made to Customers' Own Designs.

DIGBY'S Cabinets.—Write for new 16-page art catalogue.—F. Digby, 9, The Oval, Hackney Rd., E.8. Phone: Bishopsgate 6458. [0128]

KAY'S Cabinets, the greatest range of pedestal cabinets in the kingdom; original creative designs at prices 50% lower than elsewhere; quotations for specials by return; delivery at short notice guaranteed.

RADIOGRAM Cabinets.—A variety of really practical and exclusive models from 60/-; illustrated lists free.

H. KAY, Wireless Cabinet Manufacturer, Mount Pleasant Rd., London, N.17. Phone: Walthamstow 1626. 8963

CABINETS for All Requirements.—F. W. Ramsey, 63, Shaftesbury St., London, N.1. Clerkenwell 7139. [9736]

COILS, TRANSFORMERS, ETC.

TRANSFORMERS and Chokes for Battery Eliminators.—Chester Bros., 244, Dalston Lane, London, E.8. [9706]

BERCLIF Coils, the standard of excellence, for all "Wireless World" receivers; latest lists post free; trade supplied, all quantities.—Simmonds Bros., Shireland Rd., Smethwick. [9735]

GRAMOPHONES, PICK-UPS, ETC.

BROWN H.R. Pick-up, perfect; 25/-.—Badman, 12, Southside, Weston-super-Mare. [9728]

EIGHT New H.M.V. Constant Frequency Records, 28/-; B.T.H. pick-up, with arm, £1.—Temple, Knockdolian, Comrie. [9747]

TRANSMITTERS.

CHEBROS Chebros, Chebros transformers and choke; of all descriptions, special transformers for transmitting and modulation; chokes a speciality; enquiries invited.—Chester Bros., 244, Dalston Lane, London, E.8. [5240]

1,800 Kilocycle Crystals for Transmitter Control; 10/-.—Smith, Bryn Rodyn, Colwyn Bay. [9711]

VALVES.

AMPLIFIER Valve.—If you require power you cannot do better than one of these:—

FILAMENT Valve, 6, plate volts 400 (maximum), grid bias 84 volts (approx.), impedance 800 ohms, amplification factor 3.8, mutual conductance 4.35 m.a./volts; price £5/10; see article "The Wireless World," 24th July, 1929, then send to North London Valve Co., Ltd., 22½, Cazenove Rd., Stoke Newington, London, N.16. [9657]

TWO R.H.1 Rectifiers, never used, 7/6 each; 2 Mullard P.M.24 pentodes, full emission, sacrifice, 8/- each.—V.P., 32, Brixton Rd., S.W.2. [9735]

L.S.5A, 10/-; 1,000v. 30-watt rectifier, 15/-.—Royer, 10, Parolles Rd., Highgate, N.19. [9733]

LOUD-SPEAKERS.

BAKER'S SELHURST RADIO 36-page Booklet, "Sound Advice is Yours for the Asking"; write now for new edition; see displayed advertisement on page 6. [0231]

SWIFT-LEVICK Permanent Magnet and Frame, complete; £2/15.—Boston, 7, Melrose Rd., Barnes. 9725

EPOCH 99 Speaker, D.C. model, pentode coil, perfect condition; £3.—Box 6396, c/o The Wireless World. [9720]

CELESTION C14, £5; moving coil, A.C., 110-240v., complete, £6/10; Blue Spot unit and chassis, 15/-; ultra air column, £4/10 model, perfect, £2.—"Pomfrets," Hawes Lane, West Wickham, Kent. [9744]

Loud-Speakers.—Contd.

EPOCH Moving Coil Speakers are Masterpieces, designed and produced by master engineers.

EPOCH Moving Coil Speakers are the Standard by which other Speakers are Compared.

EPOCH Moving Coil Speakers are in Use in Many Editorial Offices.

EPOCH Moving Coil Speakers are in Use in Several Famous Laboratories.

EPOCH Moving Coil Speakers are in Use in Many Broadcasting Stations.

EPOCH Moving Coil Speakers are in Use by Most Prominent Musicians.

EPOCH Moving Coil Speakers Bring Unbounded Joy to Thousands upon Thousands of Homes.

EPOCH Moving Coil Speakers, the only speakers that give clear, uncoloured reproduction.

EPOCH Moving Coil Speakers do Render Speech Perfectly and Music Correctly.

EPOCH Moving Coil Speakers Provide the Perfect Illusion of the Artist's Presence.

EPOCH Moving Coil Speakers Represent the Finest Intrinsic Value Ever Offered.

EPOCH Moving Coil Speakers are Guaranteed for a Year, but last for ever.

EPOCH Moving Coil Speakers Bring the Grand Concert out of the Most Modest Set.

EPOCH—You can hear a hundred moving coil speakers, but Epoch is different.

EPOCH—If you own the best set, only by Epoch can you confirm it.

EPOCH—Away with the tin can and cracked banjo reproduction, and install an Epoch.

EPOCH—Away with the drumminess, droniness and huskiness of the average moving coil speakers.

EPOCH—The clearest, sharpest, cleanest reproduction—a marvel of accuracy and beauty.

EPOCH Moving Coil Speaker Models from £2/10 to £30.

EPOCH Moving Coil Speakers.—Models for every requirement and taste.

EPOCH Permanent Magnet Moving Coil Speakers.—Nine models from £3/15.

EPOCH Permanent Magnet Moving Coil Speakers Require no Mains or Batteries.

EPOCH Permanent Magnet Speakers are more Sensitive than most Energised Moving Coil Speakers.

EPOCH Energised Models are the Finest ever put on the Market.

EPOCH Super Cinema Speaker has Created the Biggest Sensation for Many Years.

EPOCH Super Cinema Model is many times as Sensitive as the so-called Supers.

EPOCH Super Cinema Speakers give Enormous Volume from a 1-watt Amplifier.

EPOCH Super Cinema Speakers are used on many 100-watt Amplifiers and never "rattle."

EPOCH Super Cinema Model is Standard on several Talkie Equipments.

EPOCH Super Cinema Model is already in use in over 200 Cinemas.

EPOCH Super Cinema are the only Moving Coil Speakers used in Large Theatres, unaided.

EPOCH Super Cinema Speakers provide alone the Upper as well as the Lower Register.

EPOCH—Other Moving Coil Speakers require the help of exponential horns to provide depth.

EPOCH—A list of many prominent cinemas using the Speakers supplied on request.

EPOCH Speakers are not Made of Tin or Aluminium Stampings, but are sound, solid, engineering jobs.

EPOCH Heartily Invite Comparison, on all counts, with any make, regardless of price or claims.

EPOCH—Don't accept our quality claims without verification, but don't accept any other maker's either.

EPOCH—Order one of 7 days' approval, and test with a switch-over; the only real test.

EPOCH Moving Coil Speakers may be heard in our Demonstration Room Daily.

EPOCH—Our demonstration room is in the heart of London.

EPOCH—Its accessibility has been studied for the convenience of callers.

EPOCH—If you cannot call, write for booklet W.S.3, and approval terms.

EPOCH RADIO MANUFACTURING Co., Ltd.
Farringdon Av. (near Ludgate and Holborn Circuses) Phone: Central 1971. [8983]

"Could have been sold over a dozen times!"

A recent advertiser in "THE WIRELESS WORLD" writes as follows:

"You may be pleased to know that the coils I advertised in 'THE WIRELESS WORLD' could have been sold over a dozen times.

"They were sold first post here on Thursday morning, and I had applications for them for a fortnight after."

W. A. Pelly,
Pierhead,
Eastbourne,

W.W.92.

Make Use of
The
Wireless
AND
RADIO REVIEW
World
DEPOSIT
DEPARTMENT

A recent user writes:

"Please accept my thanks for the services rendered in the purchase of the eliminator which I have decided to keep. You can therefore forward the money to the seller with my thanks.

"I shall always praise your Deposit System which is the safest way of dealing with strangers that I know of."

W. H. THEWLIS,
49, Webster Street,
OLDHAM, Lancashire.

Full particulars of "The Wireless World" Deposit System are given on the first page of Miscellaneous Advertisements.

w.w.94.

COMPONENTS, ETC., FOR SALE.

BELLING-LEE Panel Fittings are designed to give an expert finish to any home-constructed set; catalogue post free.—Belling and Lee, Ltd., Queensway Works, Ponders End, Middlesex. [0018]

COMPONENTS Lent on Hire.—Details from Alexander Black, Wireless Doctor, 55, Ebnur St., S.W.1. Sloane 1655. [0329]

NEW Kilo-Mag Four Coils, 26/- set; Mullard permeacore transformer, 14/-.—Box 6276, c/o *The Wireless World*. [9665]

FOR Sale.—P.M.14, P.M.4D and P.M.24, 30/- set; Brown Vee unit and chassis, 22/6; B.T.H. pick-up (straight), 12/6.—Briggs, 18, Cook St, Bradford, Yorks. [9712]

LEWCOS Triple Coil Unit, 35/-; Osram Music Magnet, with valves, £5; Philips large cone speaker, 35/-; Colvern, Watmel, Lotus dual coils, 6/6; set Igranite S.V. coils (4), 6/6; Junit multi switch, 3/9; Ormond cone unit and chassis, 13/-; Pye transformer, 4-1, 6/6; Geophone, 4-1, 2-1, 6/6; A.C./S.G., 12/6; A.C./H.L., 7/6; P.M.24, 12/6; U9, 8/6; U.U.60/250, 8/6; Philips 328 rectifier valves for L.T., 7/-; portable turntable, 2/9; Centralab, 250,000, 6/-; Varley Ferranti resistances, 2/6; all genuine, as new.—G. A. Ryall, 182, Kennington Rd., London. [9722]

SOLDER, specially prepared for radio jobs, 2ft. strip; 6d., post free.—C. O. Pattison, 548, Shields Rd., Newcastle-on-Tyne. [9716]

MARCONI 50H. Power Choke, 10/-; Igranite Phonovox pick-up, with arm, 12/6; Ormond 0.00035 S.L.F. friction (19/5), 6/-.—L. Royer, 10, Parolles Rd., Highgate, N.19. [9732]

RADIO HOUSE, HUDDERSFIELD, issues the Reliability Wireless Guide, which will be sent post free upon request by Messrs. J. H. Taylor and Co., 15, Macaulay St., Huddersfield. [7823]

PART Exchange.—See our advertisement under Receivers for Sale.—Scientific Development Co., 57, Guildhall St., Preston. [0228]

AVOMETER, month old, £5; other components; state requirements.—Clark, 8, Blue Halls Mansions, W.6. [9758]

FERRANTI Triple Range Meter, 35/-; pair Dubilier toroids and bases, 12/6; J.B.S.M. 0.0003, 5/-; Rothermel volume control, 1/2 meg., 5/-; Exide A.C.C. 4v. 30, 8/-; P.M.5A, 5/-; P.M.4D.X., 5/-.—Windred, 9, Ranelagh Rd., Redhill. [9757]

P.M.1A, 3/6; P.M.252, 3/6; P.M.12 (2 at 10/- each); P.M.22, 10/-; 66K Blue Spot unit, 10/6.—Elwell, 56, Greenwood Rd., Wolverhampton. [9751]

BRITISH General Tuner, 8/-; 4 Met-Vick A.C. valves, 8/6 each; A.P.3, 15/-.—Linley, 8, Harlech Rd., Leeds. [9749]

MAGNAVOX R4 M.C. Speaker, with input transformer, £3; Lissen needle armature pick-up and tone arm, 22/-; Igranite dual impedance coupler, 10/-.—Mackenzie, 63, Brigstock Rd., Thornton Heath. [9748]

BARGAINS. Bargains.

SEND or Call for Lists of Our Own Manufactured Sets, cabinets, components, etc.; must be sold; all at prices below cost.

PETO SCOTT and Co., Ltd., 77, City Rd., London, E.C.1; 62, High Holborn, W.C.1. Liverpool: 4, Manchester St. Chorlton-cum-Hardy: 33, Whiteflow Rd. [9755]

BLUE Spot's New Units.

66P. 27/6; 66R., 35/-; major chassis, 15/-; minor chassis, 10/6.

10/- Allowed for Your Old 66K. Unit if in Good Condition.—Ralph Smeeton, 9, Sansom St., Camberwell, London, S.E.5. [9760]

BANKRUPT and Surplus Stock, purchased by private treaty and by auction.—R.C. Threesome, tuning unit dual coil, grid leak and condenser, 7/6, list 17/6; plug type R.C. units, with valve holders, 5/-; list 8/6; Sterling 35 speakers, 39/6, list 24/4; Cosor 1929 sets, with valves, £5/5; Triotron units, 9/9; valves, 6/-; Mullard's half price, Marconi 6-volt half price, Cosor 2-volt S.G., 12/6, 18/6; full wave rectifying valves, 10/-; Dubilier fixed condensers, 0.0001 to 0.005, 8d. each, or 6/- dozen; Ediswan 5-way battery cords, 1/-; 6ft. speaker cords, 1/-; 100ft. aerials, 1/2; Marconi lightning switches, 2/6, list 7/6; Marconi condensers, 0.1, 0.2, 0.3, 0.4, 0.5, Mansbridge, 1/3 each; Marconi ideal transformers, 3-1, 4-1, 6-1, 8-1, 12/6, list 25/-; Atlas eliminators, 150v. 50 ma., £5/5, list 28/15; Bakelite double reading voltmeters, 4/9, list 7/6; Hailey wave selectors, 2/9, list 12/6; Ediswan waveforms, 10/6, list 21/-; Ormond drum dials, 3/11, list 5/-; 12in. aluminium chassis and cones, 7/6, list 15/-; cones, 9d. to 2/6; sets, mains transformers, moving coil speakers; thousands of bargains; state your requirements, I can save you money; set builders send for my lists; all goods guaranteed and sent on 3 days' approval.—"Commercial", Ford, Hill Crest, Horninglow, Burton-on-Trent. [9761]

Mention of "The Wireless World," when writing to advertisers, will ensure prompt attention.

Components, Etc., for Sale.—Contd.

B.T.H. Panatropo Motor Generator (input 250 v.d.c., output 720 v.d.c., 140 m.a.), ditto, 100-125 v.d.c. input (similar output), working order, in metal cases; £10/10 each.—Below.

A FEW More 3-valve Push-pull Amplifiers Left, each containing 1 Ferranti A.F.3c transformer, ditto, O.P.4c, 2 decoupling resistances, Hydra 2 and 4 mics, valve holders, terminals, etc., wired O.K., components as new; 32/6 each, carriage paid.—Below.

20 HYDRA 6 mics, tested, 1,000 volts a.c., 6/6 each, for callers only; 100 various valves, comprising Cosor 660T, L.S.6A., L.S.5A., P.625 Mullard 256, 2 Ostram super power valves, type 1 D.C.T., 1 S.W., hardly used, at bargain prices; also Weston Voltmeters, milliammeters, Pye chokes various, Polar Ideal variable condensers, Dubilier fixed condensers, Marconi Ideal transformers, etc.; 5.30-7.30 evenings.—Franks, 42, St. George's St., London, E.1. Phone: Royal 8546. [9762]

MISCELLANEOUS.

CALIBRATE Your Set with the C.D.E.S. Calibration Chart; 8d., post free.—C.D.E.S., 98, Cherry Orchard Rd., Croydon. [8612]

ALEXANDER BLACK,

THE Original Wireless Doctor, will call (London and Home Counties) and cure your set.

CONSULTATIONS by Appointment Without Obligation, sets installed, maintained, and brought up to date, gramophone pick-ups, eliminators, and Weston moving coil speakers demonstrated; purity reproduction specialists.

55, Ebury St., Victoria, S.W.1. Sloane 1655. [0277]

SCOTT SESSIONS and Co., Great Britain's Radio doctors, officially approved as wireless repairers by Radio Society of Great Britain and Wireless League; old sets of every type repaired, rebuilt, modernised; send set for immediate quotation.

SCOTT SESSIONS and Co.—New sets constructed with your or our components, guaranteed finest workmanship; we specialise in "The Wireless World" circuits; remember, we have satisfied customers throughout the British Isles and in three Continents; if you so desire, we will design and construct high grade apparatus to suit your special circumstances for quality, range and selectivity.—Tel.: Tudor 5326. Muswell Hill London, N.10. [0262]

EASY Payments.—We supply, by easy payments, components, accessories, and sets, any make; 10% down, balance spread over 11 months.—Send list of requirements to London Radio Supply Co., 11, Oat Lane, London, E.C.2. [0337]

ENGINEERS, novice or expert, £300, £400, £500 per year or more is within your grasp. In our handbook, Engineering Opportunities, Prof. A. M. Low explains where the good posts abound. This handbook has shown the way to better things to over 20,000 of your fellows. It contains details of A.M.I.Mech.E., A.M.I.E.E., A.M.I.C.E., A.M.I.A.E., A.M.I.Struct.E., Matric, C. & G., G.P.O., etc., exams, outlines home study courses in all branches of electrical, mechanical, motor and wireless engineering, and shows the unique advantages of our Appointments Department. Why stay in the Hammer and File Brigade? Send for our free handbook at once, stating branch, post or exam, which interests you.—British Institute of Engineering Technology, 87, Shakespeare House, 29-31, Oxford St., London, W.1. [9726]

PATENT AGENTS.

PATENTS and Trade Marks, British and foreign.—Gee and Co. (H. T. P. Gee, Member R.S.G.B. and A.M.I.R.E.), 51-52, Chancery Lane, London, W.C.2. Phone: Holborn 1525. [0001]

REPAIRS.

SCOTT SESSIONS and Co., Great Britain's radio doctors; read advertisement under Miscellaneous column. [0263]

REPAIRS Returned Post Free, and to ensure satisfaction send remittance after approval of same.—Leeds Wireless Repair Service.

LOUD-SPEAKERS, headphones, rewound to any resistance and remagnetised, 3/-; transformers rewound, 4/-; Blue Spots, Triotrons and 4-pole units, 4/6; work guaranteed.—Leeds Wireless Repair Service, 5, Boston Place, Green Rd., Leeds. [9659]

YOUR Set Will Receive Expert Attention at the Wireless Service Station, 48, Rectory Rd., N.16 [9753]

GUARANTEED Repairs by Experts.—Loud-speakers, headphones, cone units, pick-ups, any type, rewound, remagnetised, and adjusted post free 4/-; transformers, from 4/-.—Howell, 91, Morley Hill, Enfield, Middlesex. [9555]

OVERSEAS READERS WE SPECIALISE IN OVERSEAS BUSINESS.

PARTS, SPEAKERS, ELIMINATORS OR COMPLETE SETS

Write and tell us exactly what you require and we will buy it for you. It is our business to select suitable apparatus and thus ensure satisfaction to the user. Payment may be made either through "The Wireless World" deposit system, see page 6, or direct to us.

THE OVERSEAS TRADING CO.
144, St. Vincent Street, Glasgow, Scotland.
Telegrams: "Tenacity," Glasgow.

SUMMER CLEARANCE SALE

Wonderful unrepeatable bargains. A few are listed below.

H.T. MAINS UNITS, famous British make, 220 v. D.C. 15 m/a., 25/-; leatherette case, plug and cord. **A.C. UNITS,** 220 v. 50 cycles, 15 m/a., brand new, 45/- Super A.C. Units, Westinghouse rectifier, List 27, Sale 70/-.

FELLOWS LITTLE GIANT III in Oak Cabinet with three matched valves, 35/- List 28, Ediswan 2-valve sets, 25/6.

PORTABLE 5-v. SETS by Royal Radio, etc. Guaranteed perfect working order, wonderful range and quality, 27 5s. to clear.

LOUD SPEAKERS. Moving Coil for 220 v. D.C. Mains, £3 10s. Famous M.P.A. Cone Speakers, Oak Cabinet, 15/-, Bowdoin Crystal Sets, 3/-.

M.A. MOTOR GENERATORS 220 v. to 400 v. 100 m/a., £9. Brand new 2,000 dynamos, motors and alternators in stock. Kindly specify wants.

Our new list of 1,000 electrical and radio gadgets will interest you. Send 1d. stamp.

ELECTRADIX RADIOS, 218, Upper Thames Street, London, E.C.4.

Telephone City 0191

REPAIRS

Any make of L.F. Transformer, Loudspeaker or headphones repaired and dispatched within **48 HOURS—TWELVE MONTHS' GUARANTEE** with each repair. 4/- Post Free.

Terms to Trade.

TRANSFORMER REPAIR CO., Dept. W., 953, Garrett Lane, Tooting, London, S.W.11.

"TILTRACK"
Registered Trade Mark
Patent-STEEL STORES System

For the Wireless Experimenter, Factory Factor and Retailer,
Full Particulars from Sole Manufacturer and Patentes:—**BERTRAM THOMAS,** Worsley Street, Hulme, MANCHESTER.

EXACT TUNERS

250 to 2,000 metres.

No further coils are required, tuning is as simple as A.B.C. see "Wireless World," January 25th: "We can strongly recommend these tuners." Send postcard for particulars and Circuits FREE to

THE EXACT MANUFACTURING CO.
Croft Works, Priory Place, COVENTRY.

Repairs.—Contd.

THE BARNES RADIO SERVICE.—Repairs, rebuilding, demonstrations, radio gramophones and scratch filters; reproduction specialists; any distance.—53, High St., Barnes, S.W.13. Prospect 5633. [9705]

WANTED.

ALL Types of Electrical and Wireless Apparatus Purchased for Cash; large quantities only.—T. W. Thompson and Co., 17, Strutton Ground, S.W.1. [0331]

ONE "Experimental Wireless," July, 1929, Vol 6.—G. E. Steckert and Co., 2, Star Yard, Carey St., W.C.2. 9717

TWO P.625As, 8/6 each; 2 S.625s, 13/6 each; 2 D.E.L.610s, 6/- each; 2 H.L.610s, 6/- each; 2 P.M.14s, 13/6 each; 2 P.M.4D.X.s, 6/- each; and 2 P.M.254s, 8/6 each.—Box 6428, c/o The Wireless World. [9741]

EXCHANGE.

RADIO Part Exchange.—Particulars of the first and largest service in existence will be forwarded upon request to The Secretary, Appleby's, Chapel St., Marylebone, London. [0339]

WE Will Accept Your Surplus Apparatus (making you a high allowance) in Part Payment for any new apparatus; your enquiry will be dealt with promptly.—Bostock and Stonhill, 1, Westbourne Terrace, S.E.23. [9738]

AGENCIES.

AGENTS Wanted for All Classes of Wireless Apparatus; excellent opportunity for salesmen to add to their income; high commission.—Write Box 6419, c/o The Wireless World. 9730

SITUATIONS VACANT.

WIRELESS Operating; fees payable after appointment; amateur Morse classes.—Manager, Wireless School, 21, Manor Gardens, London, N.7. [9573]

WIRELESS Services.—The premier telegraph college in the British Isles (established 34 years) gives a sound training to all students, with assured positions on qualification; fees are not disguised under expensive board-residence scheme, but are payable by easy instalments, if desired.—Apply for Prospectus, Dept. "W.W." The London Telegraph Training College, Ltd., Morse House, Earl's Court, S.W.5. [9615]

TECHNICAL Assistant, with specialised knowledge of S.G. all-mains design.—Apply in writing, giving fullest details of technical training, etc., commencing salary, and when free, to Orchardson Sound Reproduction, Ltd., 114-116, Euston Rd., N.W.1. [9724]

ENERGETIC Amateurs Wanted as Agents.—Write South-Eastern All-Electric Co., 281, Brockley Rd., S.E.4. [9713]

JUNIOR Mechanic Required in Radio Shop, S.E. district; state experience, age; commence at 30/- per week.—Box 6427, c/o The Wireless World. [9740]

SITUATIONS WANTED.

YOUNG Man (24), good knowledge radio, electrical and mechanical engineering, 5 years' apprenticeship, seeks progressive situation, service man or otherwise, preferably London, willing travel.—Write Box 6368, c/o The Wireless World. [9710]

EX Operator (Naval), 13 years' experience, seeks situation, care and maintenance, wiring, assembling.—Box 6432, c/o The Wireless World. [9756]

YOUTH, 18, requires situation as constructor, etc.; East Lancs district preferred.—Box 6426, c/o The Wireless World. [9739]

BOOKS, INSTRUCTION, ETC.

FREE Inventor's Guide on Patents.—T. A. A., 253, (W), Gray's Inn Rd., London, W.C.1 [6373]

TELEVISION.—The complete authorised book on television (Baird Experimental) transmission and receiving, is now ready; order "Television To-day and To-morrow" (Moseley and Barton Chapple), 7/6 net.—Pitman's, Parker St., Kingsway, W.C.2. [9509]

STEP by Step Wireless.—A complete course of instruction for wireless engineers; send 1/- for first 4 weeks.—Chifford Pressland, A.M.I.E.E., Hampton-on-Thames. [0195]

"WIRELESS WORLD," 1921-1929 inclusive; what offers?—G.H.F. Whitwood, East Boldon, Durham. [9681]

INDEX TO ADVERTISEMENTS.

	PAGE		PAGE		PAGE
Abbey Radio	7	Fonteyn & Co., Ltd.	6	Perseus Manf. Co., Ltd.	6
Adolph, Fredk.	6	Gambrell Radio, Ltd.	6	Pertrix, Ltd.	3
Appleby, E. Hetherington	7	Garnett, Whiteley & Co., Ltd.	6	Phillips Lamps, Ltd.	4
Baird Television, Ltd.	4	General Electric Co., Ltd.	Cover iv.	Player's	10
Baker's "Selhurst" Radio	6	Heayberd, F. C., & Co.	6	Potter, H. B., & Co., Ltd.	10
Belling & Lee, Ltd.	6	Holzman, L.	6	Radiogramophone Development Co.	6
Burne-Jones & Co., Ltd. (Magnum)	10	Hughes, F. A., & Co., Ltd.	6	Regent Radio Supply Co.	6
Celestion, Ltd.	6	Imperial Airways, Ltd.	1	Rigby & Woolfenden	6
Cole, E. K., Ltd.	Cover i.	Jackson Bros.	1	Scientific Supply Stores	6
Concerton Radio & Electrical Co., Ltd.	Cover i.	London Electric Wire Co. & Smiths, Ltd.	2	Telegraph Condenser Co., Ltd.	Cover i. & p. 1
Day, Will, Ltd.	4	McMichael, I., Ltd.	2	Thomas, Bertram	9
Eastick, J. J., & Sons	6	M-L Magneto Synd., Ltd.	2	Transformer Repair Co.	9
Edison Swan Electric Co., Ltd.	5	Moore & Co.	2	Varley (Oliver Pell Control, Ltd.)	9
Electradix Radios	5	Mullard Wireless Service Co., Ltd.	Cover i.	Westinghouse Brake & Saxby Signal Co., Ltd.	Cover iii.
Electrocet Radio Co.	9	Overseas Trading Co.	9	Wilkins & Wright, Ltd.	Cover i.
Ever Ready Co. (G.B.), Ltd.	Cover ii.	Paroussi, E.	9	Wingrove & Rogers, Ltd.	6
Exact Manf. Co.	9	Parker, W. H.	6	Wright & Weaire, Ltd.	Cover iii.
Exide Batteries	9	Partridge & Mee, Ltd.	6	Yates Sutton, Ltd.	7

What the
Pacific Engineering
Laboratory Co. (U.S.A.) thinks
of

**EXPERIMENTAL
WIRELESS**
& The WIRELESS ENGINEER

"This is one of the
best technical wireless
journals we have
read and we heartily
recommend it to
everyone."

MONTHLY 2s. 6d. net.
Subscription: 32s. per annum, post free.

ILIFFE & SONS LTD.,
Dorset House, Tudor St., London, E.C.4

w.w.87

**DICTIONARY
of WIRELESS
TECHNICAL
TERMS**

(1926)

Compiled by S. O. PEARSON, B.Sc., A.M.I.E.E.
and issued in conjunction with
"THE WIRELESS WORLD."

This volume contains definitions of terms and expressions commonly used in wireless telephony and telegraphy and is intended to serve as a guide to all those interested in wireless who come across, from time to time, unfamiliar words in their reading. In such cases the DICTIONARY OF WIRELESS TECHNICAL TERMS proves of very great use and value. It is well illustrated, and cross-referenced to enable the required information to be rapidly obtained.

Price 2/- net. By Post 2/2

From leading booksellers or from the Publishers:

ILIFFE & SONS LTD.,

Dorset House, Tudor St., London, E.C.4.

W.W.48

PARFAIT
THE PERFECT
EBONITE

SUPPLIED IN SIX FINISHES

Semi-Polished Black
Highly Polished Black
Matt

Semi-Polished Mahogany,
Highly Polished Mahogany
Cube Surface

Obtainable from most wireless dealers.

Advertisement of H. B. Potter & Co., Ltd., Station Buildings, ROCHDALE.

Mention of "The Wireless World," when writing to advertisers, will ensure prompt attention.

**MAGNUM
SHORT WAVE
CONVERTOR**

Explore other regions. Easily adapted to your set enabling you to enjoy numerous short wave programmes hitherto unknown to you. NO EXTRA Valves or Batteries required (unsuitable for sets employing indirectly heated mains valves). A test report of this amazingly efficient instrument was given in "Wireless World," June 4th.



REVISED PRICE **£3 : 15s.** Full particulars and list of leading Short Wave Stations—Free on request.

BURNE-JONES & CO., LTD.,

"MAGNUM" House, 296, Borough High St., S.E. 1.

Telephone: BOP 6257 & 6258.

USERS OF LARGE OUTPUTS

appreciate the advantages of



METAL RECTIFIERS

which are used not only for the operation of radio equipment but also for a large number of purposes—from instrument work of a few microwatts to the operation of electrical machinery, etc., up to ten kilowatts.

The absence of moving parts, electrolytes and filaments renders them more reliable, economical and easier to use than any other means of obtaining direct current from alternating current supplies.

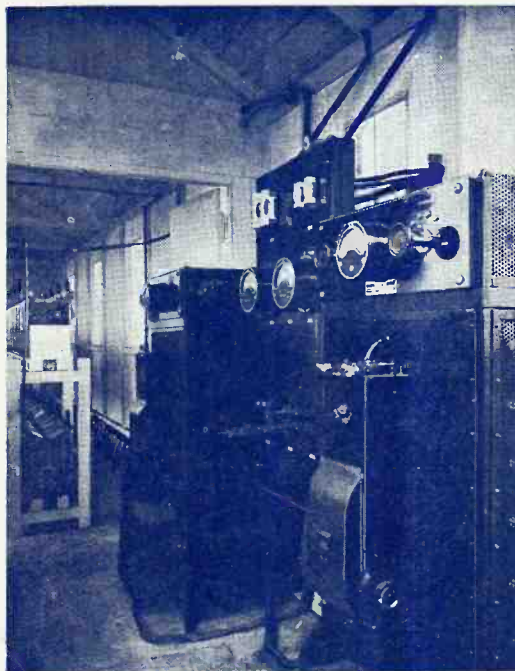

Westinghouse Metal Rectifiers in service at New Cross, Southern Railway, for charging accumulators used to operate electric point machines.

Full details and circuits for all units for radio mains equipment are given in our 32-page booklet, "The All Metal Way—1930." Send 2d. stamp for a copy to

The Westinghouse Brake & Saxby Signal Co., Ltd.,
82, York Road, King's Cross, London, N.1.

RADIO DATA CHARTS

A SERIES OF ABACS

providing most of the essential Data required in Receiver Design

By R. T. BEATTY, M.A., B.E., D.Sc.

"Radio Data Charts" provide designers of wireless apparatus with a ready and convenient means of solving problems without having recourse to complicated formulæ and mathematics.

By the use of the charts it is possible to tackle all the more familiar problems in radio receiver design; including, for example, finding the relationship between inductance capacity and frequency, and working out the design of high frequency transformers. All keen amateurs will appreciate this helpful book.

Price 4/6 net. By post 4/10.

From all leading booksellers or direct from the publishers.

Published from the Offices of
"THE WIRELESS WORLD,"

Dorset House, Tudor Street, London, E.C.4.
W.W.93

GUARANTEED

WEARITE

COMPONENTS

MAINS TRANSFORMERS AND L.F. CHOKES

Type	Output	Use	Price.
T.1	4 v 5 a	For Heaters of A.C. Valves	25/-
T.2	4 v 5 a 5.5 v 2 a 250 v 80 m/a	For H.T. & L.T. For A.C. Valves Also U.5 Type Rectifier	
T.3	135 v 0 m/a	For Westinghouse Rectifiers Styles H.T.3 & H.T.4	27/6
T.4	135 v 50 m/a 4 v 5 a	As T.3 with addition of windings for A.C. Valve Heater	32/6
T.5	230 v 50 m/a 4 v 5 a	For Westinghouse Rectifier Style H.T.1, also A.C. Valve Heater Winding	32/6

Type	CONSTANT INDUCTANCE L.F. CHOKES.			Price.
	Inductance (Henries)	Resistance (Ohms)	Current-carrying capacity	
L.T. 1	0.1	0.5	1.5 amps	18/6
L.T. 2	0.25	1.5	1.0 "	18/6
H.T. 1	10	190	120 m/a	21/-
H.T. 2	20	350	75 "	21/-
H.T. 3	40	850	50 "	21/-
H.T. 4	100	1850	25 "	21/-
H.T. 5	20	400	30 "	12/6
H.T. 6	60	2500	15 "	15/-

Special Transformer for "Orgola" High Power H.T. Supply Unit 30/-
H.F. By-Pass Unit 4/6

Write for free illustrated lists

WRIGHT & WEARE LTD.,
740, HIGH ROAD, TOTTENHAM, N.17. Phone: Tottenham 3847/8.

EVERYTHING



ELECTRICAL

IMMENSE POWER

WITH PERFECT PURITY

Radio Engineers throughout the world are realising that the true worth of a Power Valve lies in its permissible watts dissipation at the anode, this being a reliable guide to the useful power available to the loudspeaker.

The OSRAM P.X.4 is designed with characteristics so that, with an anode voltage of 200, the undistorted power output hitherto only obtainable by valves in the 400-volt class, is possible. You will not necessarily require all this power all the time, but the use of the OSRAM P.X.4 in the last stage of your A.C. set or radio gramophone means that the sudden loud passages can be handled by the loudspeaker with perfect purity—the piano will sound like a piano, and there will be no “cracked notes.”

OSRAM Power Valves have for years been the choice of experts in sound reproduction.

Characteristics:

Filament Volts	4.0
Filament Current	0.6 amp.	approx.
Anode volts	200	max.
Anode dissipation	10	watts max.

PRICE 25/-

Instructions for use are enclosed in each carton.

OSRAM P.X.4
(*Super Power*)
for A.C. Mains sets & Radio Gramophones



Osram
A.C. Mains
Valves
FOR ECONOMICAL WIRELESS

MADE IN ENGLAND

Sold by all Wireless Dealers

Advt. of The General Electric Co., Ltd., Magnet House, Kingsway, London, W.C.2.

Printed for the Publishers, ILIFFE & SONS LTD., Dorset House, Tudor Street, London, E.C.4, by The Cornwall Press Ltd., Paris Garden, Stamford Street, London, S.E.1.

Colonial and Foreign Agents:
 UNITED STATES—The International News Co., 131, Varick Street, New York. FRANCE—W. H. Smith & Son, 248, Rue Rivoli, Paris; Hachette et Cie, Rue Réaumur, Paris.
 BELGIUM—W. H. Smith & Son, 78, Marche aux Herbes, Brussels. INDIA—A. H. Wheeler & Co., Bombay, Allahabad and Calcutta. SOUTH AFRICA—Central News Agency, Ltd.
 AUSTRALIA—Gordon & Gotch, Ltd., Melbourne (Victoria), Sydney (N.S.W.), Brisbane (Queensland), Adelaide (S.A.), Perth (W.A.), and Launceston (Tasmania).
 CANADA—The American News Co., Ltd., Toronto, Winnipeg, Vancouver, Montreal, Ottawa, St. John, Halifax, Hamilton; Gordon & Gotch, Ltd., Toronto; Imperial News Co., Toronto, Montreal, Winnipeg, Vancouver, Victoria. NEW ZEALAND—Gordon & Gotch, Ltd., Wellington, Auckland, Christchurch and Dunedin.

The "BAND PASS FOUR"—Constructional Article.

The Wireless World

AND RADIO REVIEW

4^D

The Paper for Every Wireless Amateur

Wednesday, June 25th, 1930.



TELSEN
L.F. TRANSFORMERS
Radio's Choice

Have acquired a world-wide reputation for Quality and Value. Built by Specialists in Transformer construction they have set a Quality of Performance above reproach. Your Set will work better with a Telsens Transformer . . . Fit one now!

Radiogram 12/6
Ratios 3-1 & 5-1
Radiogram 7-1
Ratio Price 17/6.

TELSEN ELECTRIC CO. LTD. Miller St. Birmingham.

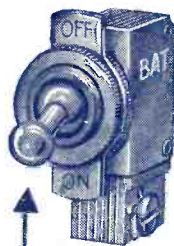

NEW 750-WATT Q.M.B. RADIO OR POWER SWITCH

Latest Model: easily breaks 3 Amps @ 250 V. "Q.M.B." Action: Indicating: Screw Terminals, obviating Soldering: Live Parts Insulated from Lever: One Hole Fixing: Nickel Finish. Small: Neat: Efficient: Guaranteed fully.

For Radio or Power, Gramo-Motor Control, M/C. Speaker Field Switch: Small Motor Switch: Eliminators: Chargers: Portables, etc. As supplied to many leading Manufacturers.

ONLY 2/6

LYONS' "B.A.T." No. 730 2/6
(TYPE 728—SOLDER TAGS) NOW 2/3

—CLAUDE LYONS, LIMITED,

Head Office:—76 OLDHALL ST., LIVERPOOL.
LONDON:—40 BUCKINGHAM GATE. S.W.1.

A QUALITY VALVE AT A CHEAPER PRICE

TUNGSRAM

TUNGSRAM ELECTRIC LAMP WORKS (GREAT BRITAIN) LTD.,
Radio Dept.,
72, Oxford Street,
London, W.1



BurTON

SELF-LOCATING VALVE HOLDER



1/- each

Pentode-Valve-Holders 1/6 each

Patent No. 318708

MANUFACTURED BY C. F. & H. BurTON

PROGRESS WORKS WALSALL, ENG.

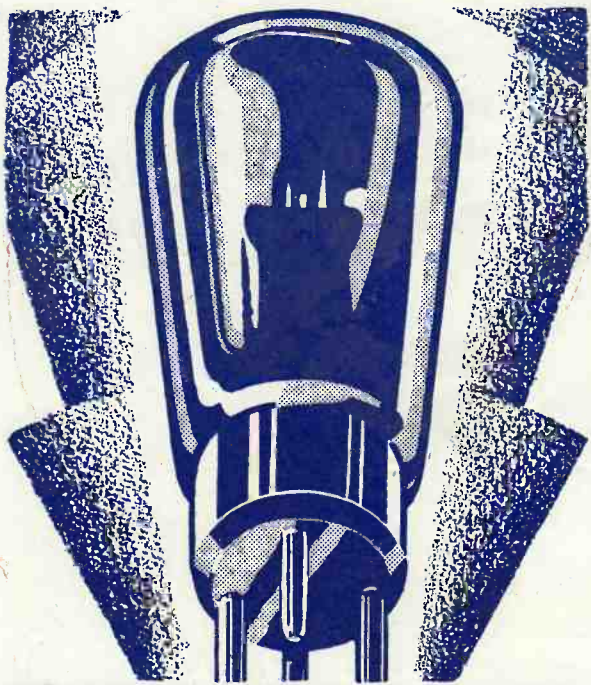

**THE VERY LAST
WORD IN —**

**VALVE PERFORMANCE!
VALVE DESIGN!
VALVE PRICE!**

The filament of colloidal structure in the new Vatea Valve is the very last word in valve design. This valve gives a performance which has never previously been thought possible, and its price is a remarkable achievement. The new Vatea Valve gives not only greatly improved selectivity, but greater volume and incredibly better tone. And look at the prices!

**6/- H.F. AND SUPER 7/6
- DETECTOR POWER**

Power 7/-; Screened Grid 16/-; Pentode 16/-; also complete range of Indirectly Heated A.C. Mains Valves.

**VATEA
THE NEW VALVES
STYLE**

ABBEY RADIO,
47, Victoria Street, London, S.W.1.
Telephone No.: Victoria 3914.

**CONDENSED
CHATS**

By
**DOCTOR
DUCON**

No. 2. TALK ON TOROIDS

If the utmost amplification is to be obtained from an H.F. Amplifier it is necessary, among other things, to avoid interaction between the grid and anode Circuits on the H.F. side. If screening by means of metal boxes or shields is resorted to, the H.F. losses due to eddy currents will in all probability be unduly high unless the set is built of such dimensions as to be unreasonably bulky.

The only remedy is to use Toroids throughout. This renders screening unnecessary by reason of the fact that the field of the coil is enclosed within the coil itself, thus increasing efficiency and simplifying construction to a large degree.

*Dubilier Toroids
are made for all
wave bands from
22.5 to 2,000
metres. Prices
from
10/6 to 15/-*



**DUBILIER
CONDENSER CO. (1925) Ltd.**

DUCON WORKS, VICTORIA ROAD, N. ACTON, LONDON, W.3

Mention of "The Wireless World," when writing to advertisers, will ensure prompt attention.

EVERYTHING



ELECTRICAL

IMMENSE POWER WITH PERFECT PURITY

Radio Engineers throughout the world are realising that the true worth of a Power Valve lies in its permissible watts dissipation at the anode, this being a reliable guide to the useful power available to the loudspeaker.

The OSRAM P.X.4 is designed with characteristics so that, with an anode voltage of 200, the undistorted power output hitherto only obtainable by valves in the 400-volt class, is possible. You will not necessarily require all this power all the time, but the use of the OSRAM P.X.4 in the last stage of your A.C. set or radio gramophone means that the sudden loud passages can be handled by the loudspeaker with perfect purity—the piano will sound like a piano, and there will be no “cracked notes.”

OSRAM Power Valves have for years been the choice of experts in sound reproduction.

Characteristics :

Filament Volts	4.0
Filament Current	0.6 amp. approx.	
Anode volts	200 max.	
Anode dissipation	10 watts max.	

PRICE 25/-

Instructions for use are enclosed in each carton.

**OSRAM
P.X.4
(Super Power)
for A.C. Mains
sets & Radio
Gramophones**



**Osram
A.C. Mains
Valves**

**MADE IN
ENGLAND**

Sold by all
Wireless Dealers

FOR ECONOMICAL WIRELESS

Advt. of The General Electric Co., Ltd., Magnet House, Kingsway, London, W.C.2.

All Advertisements for "The Wireless World" are only accepted from firms we believe to be thoroughly reliable.

TWO NEW BLUE

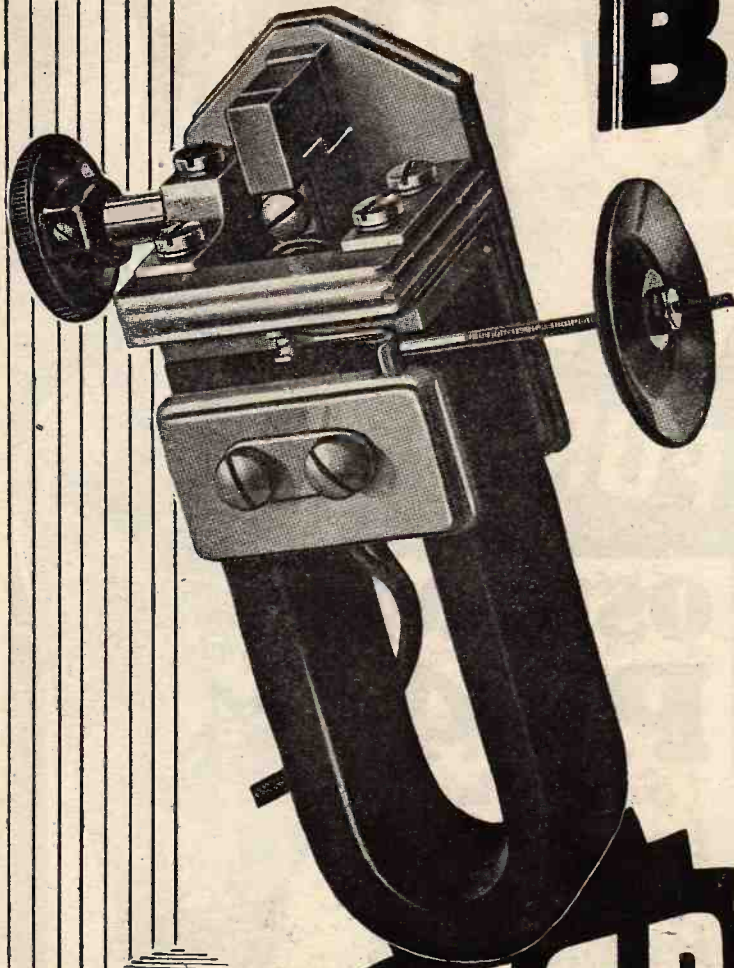

66P—THE BETTER UNIT

All who have heard the famous 66K Unit will agree that the results were so good that an improvement would be very difficult. But we can now say very triumphantly that the P Unit is not only an improvement on the K Unit but is also a big step forward in the development of loudspeaker results.

Into this Unit have been built all the improvements which two years' intensive research work has discovered and established. We have designed and patented an entirely new method of moving the anchor between the four poles, and this improvement is incorporated in the 66P Unit. The adjustment is now so micro-metrically precise that it is possible to position the anchor to the *exact* position, that is, the position indicated by the latest theoretical data as necessary to obtain the best results.

Not only does this development result in greatly increased sensitivity, it also gives a much larger range of musical frequencies. The rich beauty of the lower bass is now reproduced with its full complement. And the upper register which determines so largely the *character* of both speech and music is reproduced with the utmost fidelity.

- Blue Spot Power Unit Type 66P 27/6
- Blue Spot Major Chassis Type 37P 15/-
- Blue Spot Special Chassis Type 31P 10/6
- Blue Spot Minor Chassis Type 28P 9/-
- Permissible D.C. Current..... 30 m/a.
- D.C. Resistance..... 1,000 ohms.



F. A. HUGHES & CO., LIMITED,

Mention of "The Wireless World," when writing to advertisers, will ensure prompt attention.

SPOT



TRIUMPHS!

66R — BLUE SPOT'S MASTERPIECE

This wonderful Unit has been designed to handle the enormous outputs obtainable from modern receivers using super power valves. By means of a patented device the Unit is capable of handling outputs that would shatter the ordinary unit. The wonderful adjustment of this Unit enables it to handle with safety outputs of sufficient volume to set up vibrations in the surrounding floor and furniture. The friction developed on vibrations of such amplitude would wear out the anchor support on any ordinary unit.

And with this strength to handle volume is the power to reproduce with a faithfulness and brilliance such as you have never heard before. The whole gamut of audio frequencies is reproduced faithfully and precisely without loss and without addition.

For years we have concentrated on the production of this Unit, and among the many great things produced by Blue Spot it is the greatest. It is Blue Spot's Masterpiece!

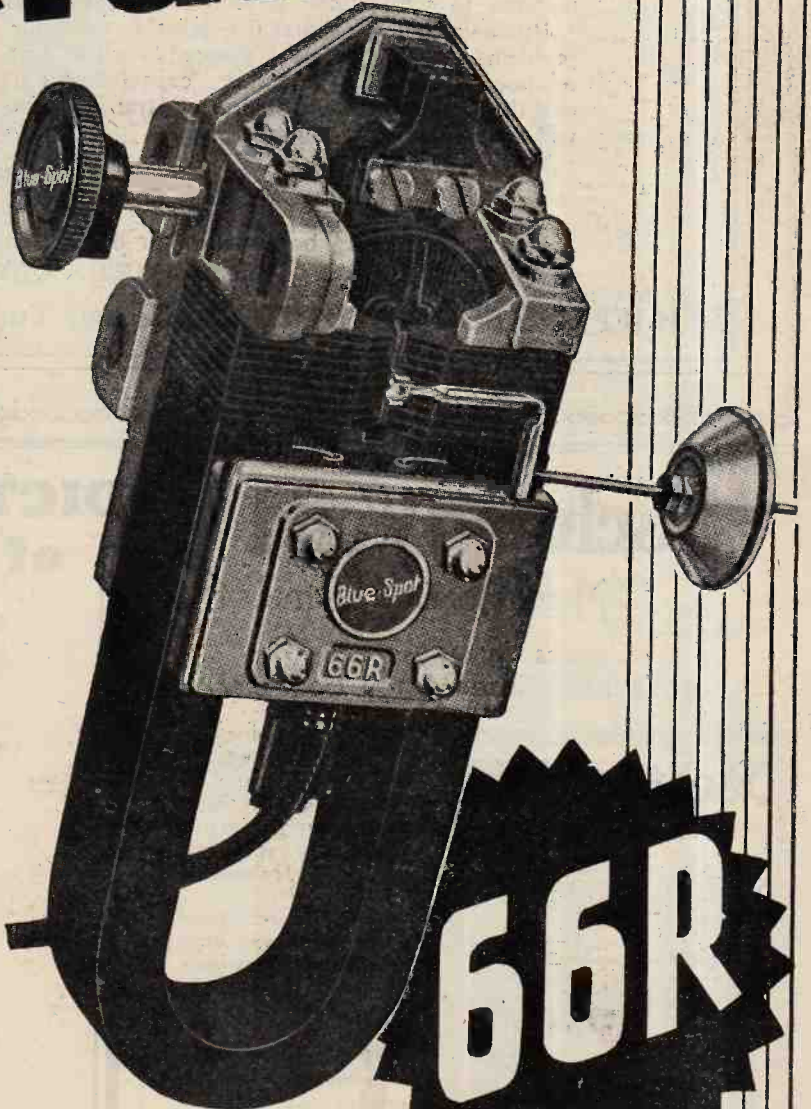

66R

35/-

- Blue Spot Power Unit Type 66R 35/-
- Blue Spot Major Chassis Type 37R 15/-
- Blue Spot Special Chassis Type 31R 10/6

Permissible D.C. Current 50 m/a.
D.C. Resistance 500 ohms.

204-206, GREAT PORTLAND STREET - - - LONDON, W.1

Phone: Museum 8630 (4 lines).

Distributors for Northern England, Scotland and North Wales: H. C. RAWSON (Sheffield and London), LTD., 100, London Road, Sheffield. Phone: Sheffield 26006. 22, St. Mary's Parsonage, Manchester. Phone: Manchester City 3329.

RADIO DATA CHARTS

A SERIES OF ABACS

providing most of the essential Data required in Receiver Design.

By R. T. BEATTY, M.A., B.E., D.Sc.

Reprinted from "The Wireless World."

"Radio Data Charts" provide designers of wireless apparatus with a ready and convenient means of solving problems without having recourse to complicated formulæ and mathematics.

By the use of the charts it is possible to tackle all the more familiar problems in radio receiver design; such as, for example, finding the relationship between inductance capacity and frequency, and working out the design of high frequency transformers. All keen amateurs will appreciate this helpful book.

Price 4'6 net. By post 4'10.

(39 CHARTS and more than 50 Diagrams.)

From all leading booksellers or direct from the Publishers.

Published from the Offices of "THE WIRELESS WORLD."

ILIFFE & SONS LTD., Dorset House, Tudor St., London, E.C.4.

W.W.93

The Yachting World and Motor Boating Journal

Covers Every Aspect
of Yachting and Motor Boating

FOUNDED 1894

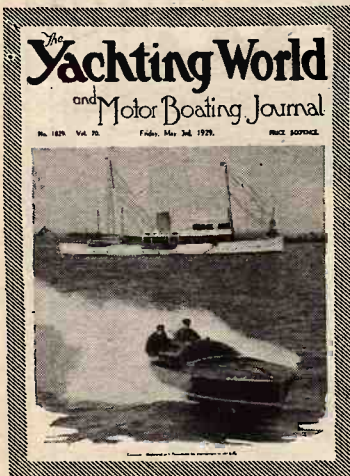

All who are interested in power-craft, whether cruisers, speed-boats or outboards, will enjoy reading "THE YACHTING WORLD and MOTOR BOATING JOURNAL."

It is a well-produced and attractive paper dealing with yachts and boats of all types and tonnages on sea and inland waters.

Racing, cruising, deep-sea sailing, practical seamanship and the construction of small craft are among the chief subjects of interest.

SUBSCRIPTIONS: Home and Canada, £1. 10. 4, other countries abroad £1. 12. 6, per annum, post free.

Every Friday 6^p.

ILIFFE & SONS LTD., Dorset House, Tudor Street, London, E.C.4.

W.W.81

DICTIONARY of WIRELESS TECHNICAL TERMS

(1926)

Compiled by S. O. PEARSON, B.Sc., A.M.I.E.E.
and issued in conjunction with
"THE WIRELESS WORLD."

This volume contains definitions of terms and expressions commonly used in wireless telephony and telegraphy and is intended to serve as a guide to all those interested in wireless who come across, from time to time, unfamiliar words in their reading. In such cases the DICTIONARY OF WIRELESS TECHNICAL TERMS proves of very great use and value. It is well illustrated, and cross-referenced to enable the required information to be rapidly obtained.

Price 2' net. By Post 2'2

From leading booksellers or from the Publishers:

ILIFFE & SONS LTD.,

Dorset House, Tudor St., London, E.C.4.

W.W.48

Mention of "The Wireless World," when writing to advertisers, will ensure prompt attention.

A4



NICORE 1 Transformer for all Receivers

An amplification curve of almost 80, and a frequency response curve practically uniform over the whole audible frequency range; that is what the National Physical Laboratory curve tells of the Varley Nicore 1 Transformer.

Nicore 1 gives to a set purity and richness of tone; helps to keep the balance of clear treble and powerful bass; gives to radio the quality of life.

The use of a nickel iron alloy core, coupled with long and varied experience in winding transformer coils, enables VARLEY to produce transformers of exceptional performance.

Use Varley Nicore 1 in your set—you will lay a foundation upon which can be built radio that will live.

Write for Section D of the Varley Catalogue.

NICORE 1 L.F. TRANSFORMER Ratio 4 to 1 **£1**



Advertisement of Oliver Pell Control Ltd., Kingsway House, 103, Kingsway, London, W.C.2. Telephone: Holborn 5303.

Advertisements for "The Wireless World" are only accepted from firms we believe to be thoroughly reliable.



Sometime, NEVER!

IS THAT THE KIND OF STORES YOURS IS?

Why not install "TILTRACKS"—the stores where goods can be found instantly, and handled with ease and rapidity? They are a big advance on old-fashioned dark and dismal wooden shelves. They save many pounds per year.

Write for Lists.

THE "BENCHRACK" (Tiltrack Principle)

A real help for storing small parts such as Terminals, Nuts, Washers, Insulators, etc. Made to stand on the work bench, it enables all small parts needed for the job in progress to be stored where they are immediately to hand. All the trays are tilted so that the parts stored can be seen at a glance, and the front faces of the trays are rounded so that the smallest parts can be swept up the slope with the fingers of one hand. Each tray is provided with patent hinging partitions which can be moved quickly to make larger or smaller compartments. Being so accessible these racks greatly facilitate stocktaking and being all steel there is no danger of fire. The Experimenter will do his jobs much quicker and with greater pleasure, and the Factory will save many pounds per year by installing this Benchrack.

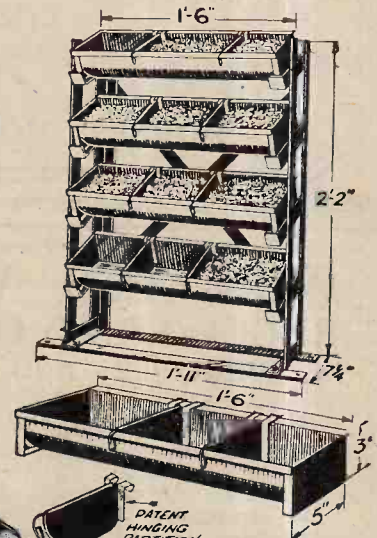

30/- F.O.R.

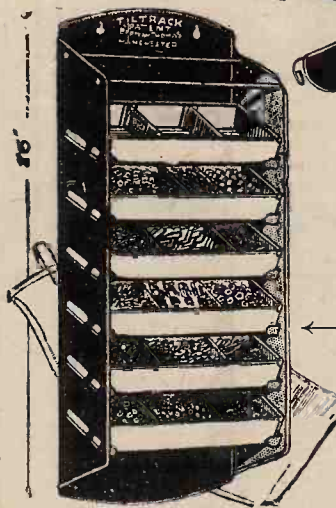

"TILTRACK JUNIOR"

This all-steel rack is designed to hang against a wall or other convenient position, and is a most excellent rack for storing small parts. It is supplied complete with white canvas protective cover to keep out the dust. All the trays are tilted and have movable partitions.

30/- POST FREE.

THERE ARE MANY MORE STYLES OF "TILTRACKS." PLEASE SEND FOR LISTS.

Particulars from Manufacturer & Patentee:—

BERTRAM THOMAS,

Worsley Street, Hulme, MANCHESTER.

London Office and Showroom:—28, Victoria Street, S.W.1.

WIRELESS DIRECTION FINDING and DIRECTIONAL RECEPTION

By R. KEEN, B.Eng. (Hons.).

SECOND EDITION (1927): Revised and Enlarged

This volume deals with the principles of the subject and the constructional details of direction finding installations, and includes some information concerning aircraft installation. It describes the principles of Direction and Position Finding in this country in such a way that the subject may be grasped easily by engineers tackling this field of wireless work for the first time. Numerous photographs and diagrams are included, and the book will prove of the utmost use and value to advanced workers, who are interested in this aspect of wireless.

Price 21/- net. By post 21/9.

From leading booksellers or direct from the Publishers:

**ILIFFE & SONS LIMITED,
DORSET HOUSE, TUDOR STREET, LONDON, E.C.4.**

w.w.68.

WIRELESS VALVE RECEIVERS & CIRCUITS IN PRINCIPLE AND PRACTICE

(1925)

By R. D. BANGAY & N. ASHBRIDGE, B.Sc.

THIS BOOK will add to the pleasure of the amateur wireless experimenter by extending his theoretical knowledge of the whys and wherefores of valve receivers.

The subject is treated from a standpoint that will enable the home constructor to understand the working of any circuit which he may evolve, and he thus becomes independent of published diagrams and specifications. The volume is well illustrated.

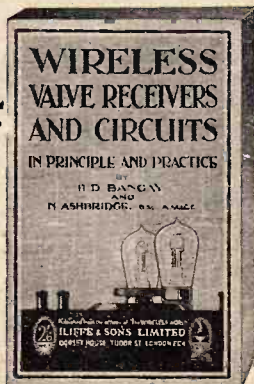

PRICE
net **2/6**

By Post 2/10.

*Obtainable from all
leading booksellers,
or direct from the
publishers:*

ILIFFE & SONS LTD., Dorset House, Tudor St., London, E.C.4

w.w.40.

SPECIAL STUDENTS' LIBRARY EDITION

FIFTY YEARS of ELECTRICITY

THE MEMORIES of an ELECTRICAL ENGINEER

(1921)



By
*Sir Ambrose
Fleming,*
M.A., D.Sc., F.R.S.

IN THIS volume the author places before the general reader a review of the chief triumphs of applied electricity during the last half-century.

Dr. Fleming has a word to say upon every phase of applied electricity; he indicates the trend of present research and suggests the course of future progress and development.

Every student should make a point of obtaining a copy of this special edition of what may be regarded as a classic of technical literature.

PRICE

15/-

net

By post 15/9

*From leading
booksellers or
direct from the
Publishers:*

ILIFFE & SONS LTD., Dorset House, Tudor St., London, E.C.4

w.w.44

Mention of "The Wireless World," when writing to advertisers, will ensure prompt attention.

B2

Sound in principle

**SAYS
THE**

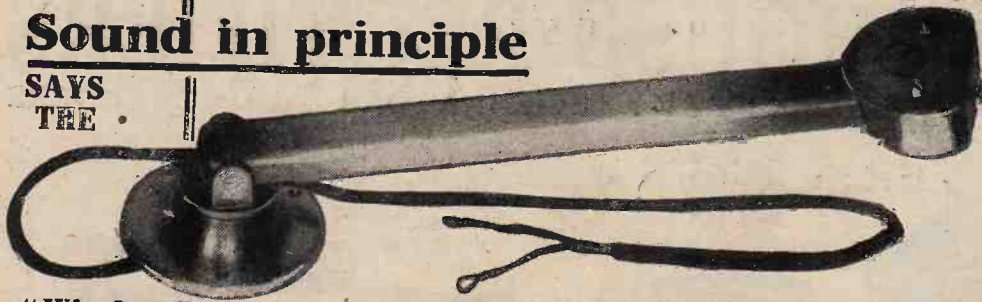

**"Wireless
World."**

**THE R.G.D.
PICK-UP**

is free from resonance. No tracking wear. Abhighly finished Pick-up in Bronze, Oxidised Silver. Specially constructed for the Coil-driven Speaker.

Price
£2:10:0

Post free.

Special Agencies vacant for the Autumn.

THE RADIOGRAMPHONE DEVELOPMENT CO.,
72, MOORE STREET, BIRMINGHAM.

Everyone
who owns a Camera
will find the

**OPEN AIR
NUMBER** of

**The AMATEUR
PHOTOGRAPHER
& CINEMATOGRAPHER**

full of interesting information, practical hints and tips, and many attractive pictures. An enlarged Art Supplement is included. Get your copy!

EVERY WEDNESDAY 3D.

From all Newsagents and Bookstalls!

ILIFFE & SONS LTD., LONDON, E.C.4

*Weston sets the
world's
standard*



Model 528, Pocket Size
A.C. Tester

A small and reliable instrument essential to maintain accuracy and efficiency in Voltage control. The sensitivity is remarkably high, 6 m.a. for 600 volts with self-contained resistance. The Scale is very legible and the damping excellent. This instrument is capable of continuous service at full load.

Prices from

£3 . 10 . 0 to £4 . 15 . 0

WESTON

ELECTRICAL INSTRUMENT
CO., LTD.

15, Great Saffron Hill, London, E.C.1

A.1

REPAIRED VALVES—AS GOOD AS NEW

When Done
By —

LUSTROLUX Ltd.

AND DON'T FORGET
"LUSTROLUX" BRITISH-MADE
NEW VALVES

The S.G.2. SCREENED GRID VALVE—2 volts only 15/-

"A" Type.

2, 4 & 6 volts H.F. L.F. R.C. POWER 5/- ea.

"Super" Type, Pipless.

2, 4 & 6 volts H.F. L.F. R.C. POWER 5/- ea. 7/- ea.

WHY WASTE MONEY ON NEW VALVES? If you have any damaged RING valves let us repair them. We guarantee that their original characteristics will be retained. They will be as good as new. Try us. You will save money.

ALL RING VALVES REPAIRED.

Price as follows:—

QUICK

L.F. H.F. R.C. - 5/3

Power Valve - - 6/3

Screened Grid - 11/3

ORIGINAL CHARACTERISTICS GUARANTEED

From your Dealer or Direct from—LUSTROLUX LTD.,

Lower House Mills, West Bollington, Nr. MACCLESFIELD.

Scottish Agent: Messrs. Bothwell Elec. Co., 54, Eglinton Street, Glasgow.

B) Advertisements for "The Wireless World" are only accepted from firms we believe to be thoroughly reliable.

WESTINGHOUSE RECTIFIERS

FOR HIGH TENSION BATTERY ELIMINATORS AND CHARGERS

200 volts
100 m.a.
Type H.T.1



150 volts
50 m.a.
Type H.T.4



120 volts
20 m.a.
Type H.T.3



“The All-Metal Way, 1930”

32 pages of valuable eliminator information, with circuits, etc. All users of A.C. Supplies should have one.

Send your name and address and a 2d. stamp to:—

The Westinghouse Brake & Saxby Signal Co. Ltd.,
82, York Road, London, N.1.



METAL RECTIFIERS

are unquestionably the most convenient and reliable means of rectification yet devised. The circuits are simple, and the rectifiers have nothing to wear out and do not require periodical replacement. That is why they are now being used in such large numbers by the leading manufacturers.

D.C to A.C

If your supply mains are D.C. you can operate an A.C. All-Electric Receiver by using the



D. C. to A. C.
ROTARY TRANSFORMER

Can be supplied to run from any voltage 12-250 V.D.C. 40 watt model £13; 85 watt model £19. Recommended and used by Philips Radio, Marconiphone, Burndept, Kolster-Brandes, M.P.A., Etc., Etc.

Write for Pamphlet 596/1 which gives full details.

THE M-L MAGNETO SYND. LTD.,
Radio Dept., COVENTRY.

Telephone: 5001.

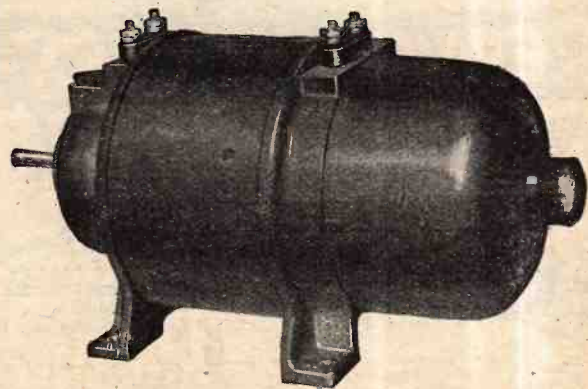

Mention of "The Wireless World," when writing to advertisers, will ensure prompt attention

The Wireless World

AND
RADIO REVIEW
(18th Year of Publication)

No. 565.

WEDNESDAY, JUNE 25th, 1930.

VOL. XXVI. No. 26.

Editor: HUGH S. POCOCK.
Assistant Editor: F. H. HAYNES.
Editorial Offices: 116-117, FLEET STREET, LONDON, E.C.4
Editorial Telephone: City 9472 (5 lines).
Advertising and Publishing Offices:
DORSET HOUSE, TUDOR STREET, LONDON, E.C.4.
Telephone: City 2847 (13 lines). Telegrams: "Ethaworld, Fleet, London."
COVENTRY: Hertford Street.
Telegrams: "Cyclist, Coventry." Telephone: 5210 Coventry.
BIRMINGHAM: Guildhall Buildings, Navigation Street.
Telegrams: "Autopress, Birmingham." Telephone: 2970 and 2971 Midland.
MANCHESTER: 260, Deansgate.
Telegrams: "Iliffe, Manchester." Telephone: 8070 City (4 lines).
GLASGOW: 101, St. Vincent Street, C.2.
Telegrams: "Iliffe, Glasgow." Telephone: Central 4857.
PUBLISHED WEEKLY.
Subscription Rates: Home, £1 1s. 8d.; Canada, £1 1s. 8d.;
other countries abroad, £1 3s. 10d. per annum.
Entered as Second Class Matter at New York, N.Y.
As many of the circuits and apparatus described in these pages are covered by patents, readers are advised, before making use of them, to satisfy themselves that they would not be infringing patents.

CONTENTS OF THIS ISSUE.

	PAGE
EDITORIAL VIEWS	659
THE BAND PASS FOUR. BY W. T. COCKING	660
A POWERFUL OUTPUT VALVE FOR 200 VOLTS	666
CURRENT TOPICS	669
SHORT WAVE SHIPS TRANSMITTER. BY M. REED	671
KIT CONSTRUCTORS' NOTES	674
WIRELESS THEORY SIMPLIFIED, PART XXXIV. BY S. O. PEARSON	676
LABORATORY TESTS ON NEW APPARATUS	679
BROADCAST BREVITIES	681
CORRESPONDENCE	682
READERS' PROBLEMS	683

the cost of producing receivers for both long and short waves is an additional task for the British manufacturer and necessitates, as one would naturally expect, some increase in the cost to the purchaser of a set as compared with a receiver operating on short waves alone. The manufacturer is not likely to continue to include the long-wave facilities for reception in his receivers if there is no public demand, and the demand must depend upon the policy of the B.B.C. in regard to the long-wave station. It must be remembered that the patent situation no longer ensures, as it formerly did, the exclusion of American receivers, all of which are designed for the short-wave band only, and if in this country long waves can be ignored as a result of B.B.C. action, then the British manufacturer will find himself competing on the same footing with American importers, and British endeavour to perfect a dual wavelength receiver over the whole period during which British broadcasting has been in operation will have been very largely a wasted effort and an effort, too, which has, in no small measure, acted as a handicap in the matter of design, preventing the British manufacturer from getting down to mass-production methods.

A Second 5XX for Alternative Programmes.

These comments may seem to suggest that 5XX, the long-wave station, ought never to have existed and that it has only served to retard progress in receiver design in this country, but we hasten to correct any such impression. Our view is that the long-wave station is of very great importance and that its value is being under-estimated. Quite apart from its usefulness in this country, particularly in areas where shipping interference is experienced, it is a station which, on account of its power and long range, with absence of fading, maintains British broadcasting prestige abroad.

Before overcrowding of the ether on the longer wavelengths has reached a stage which makes it impossible to accommodate any further stations, we would strongly urge that the B.B.C. should consider the advisability of staking a claim for a second long wavelength, so that long-wave stations can give alternative programmes and so complete the regional scheme. One station can be put up in a comparatively short time, and it might be well worth while for the B.B.C. to consider whether a second 5XX should not be proceeded with at once to provide an alternative programme on long wavelengths during the period, which it seems likely will be protracted, under which the short-wave regional stations are being constructed.

SHOULD 5XX BE DUPLICATED?

WHEN 5XX, the Daventry long-wave station, was first put up large areas of the country were able to enjoy the service of broadcasting for the first time, not only because of the power and range of 5XX, but also for the reason that the shorter wave stations were badly interfered with at any distance, and especially in coastal districts on account of shipping traffic. Apart from our own country, 5XX has always been, and still is, regarded on the Continent as the principal British station, mainly by virtue of the fact that the longer wavelength is comparatively immune from fading. It would seem to us that there is at present a tendency to neglect 5XX and to look upon it as a part of the B.B.C. service which may become unnecessary when the regional scheme gives alternative short-wave programmes throughout the country.

There are several reasons why it is desirable that assurances should be given by the B.B.C. that 5XX will remain an essential station. The complication and



The Band Pass Four

A Selective Four-stage Receiver for High-quality Reception.

By W. T. COCKING.

THE performance demanded of a modern wireless receiver is continually becoming more and more exacting. A set which, a few years since, would have been thought extremely good is to-day considered but mediocre. Almost from the beginning of broadcasting the demand has been for better and better quality of reproduction, and, although the loud speaker is still the weakest link in the chain, the reproduction from most sets is capable of improvement. The recent introduction of high-power broadcasting stations has created, in addition, a demand for selectivity of an order hitherto unknown in this country. Since the demand for quality has in no way abated, the difficulties in the way of obtaining the necessary degree of selectivity have been considerable. Among other requirements of the modern receiver may be mentioned A.C. mains operation, single-control tuning, and the inclusion of switching for wave-changing.

In the receiver described in this article, the above desirable properties have been all included, and in a form which will give reliable and trouble-free operation, with as simple a construction as possible. The detector and output stage of this receiver give practically perfect amplification over the whole range of frequencies from 30 to 8,000 cycles; and the presence of this frequency band is necessary for the best quality. In designing the H.F. amplifier, therefore, care has been taken to ensure that the over-all frequency characteristic is, as far as possible, flat within these limits. There is, of course, no low-note cut-off in an H.F. circuit, so that consideration need only be given to the preservation of

high notes. At the same time, however, the selectivity must be sufficiently high to allow of good Continental reception at short distances from local high-power transmitters. These requirements can only be obtained at present in a simple form by the use of band-pass filters, which have been fully described in these columns by A. L. M. Sowerby¹ and the present writer.²

Experience is the best guide with regard to selectivity, and it has been found that no fewer than five tuned circuits are necessary in order to obtain a really high degree of this essential quality, without an excessive loss of high notes. Since two H.F. stages are necessary for satisfactory sensitivity, the tuned circuits take the form of two band-pass filters for the aerial and first H.F. circuits, and a single-tuned grid circuit for the detector coupling, where the damping is greatest.

The stray reactions always present in an H.F. amplifier profoundly modify the filter characteristics; at the same time, if they be removed by any means, the amplification falls considerably, and three stages become desirable. In this receiver the stray reactions are fully present, but, as they are under complete control, they have no effect upon the filter characteristics when receiving the stronger of the Continental stations. Oscillation is avoided by connecting a portion only of the anode coils in circuit, in the well-known manner, and the adjustment is such that

SPECIFICATION.

- Band-Pass Filter Tuning** giving high selectivity with retention of sidebands.
- Two H.F. Stages** with A.C. screen-grid valves, giving high sensitivity.
- Power Grid Detection** combining distortionless rectification with efficiency.
- Push Pull Output** reducing distortion and hum. Power output to loud speaker of suitable impedance about 1,500 milliwatts.
- Complete A.C. Mains Operation** with special progressive smoothing circuit.
- Single Tuning Control** with ganged condensers. Wave-change switching.
- Volume Control** by high resistance potentiometer in H.F. circuit.
- Grid Bias** obtained automatically from voltage-dropping resistances.

¹ "Selectivity of Coupled Coils," Feb. 26, 1930, and "Capacity Coupled Filters," April 2 and 9, 1930.

² "Selectivity and Quality," Oct. 30, 1929, and "High Selectivity," Jan. 8 and 15 1930.

The Band-Pass Four.

the receiver, with the volume control set at maximum, is not far from instability, thus giving maximum sensitivity. As the volume control is rotated from the position of maximum volume, the first filter becomes partially isolated from the succeeding circuits, and the effects of the stray reactions then become negligible.

The volume control takes the form of a 500,000-ohms potentiometer R_1 , Fig. 1, shunted across the secondary tuning condenser of the aerial circuit filter. In this position it does not alter the working potentials of the valves, and is quite distortionless; it has no effect upon quality or selectivity other than that caused by a reduction in the feed-back effects.

Capacitive coupling is adopted in the filters, since it is the most effective for a variety of reasons. The

need by-passing to the cathodes; a 2-mfd. condenser C_{25} , of course, is connected to negative H.T., but this is more for smoothing than for by-passing.

Owing to the method of volume control adopted, it is impossible to decouple the grid circuit of the first H.F. valve; but a 1-mfd. condenser C_8 is connected from the lower end of the volume-control resistance to the cathode. Decoupling of the second H.F. grid circuit is unnecessary, owing to the particular connection of the 0.5-meg. resistance R_3 , through which the biasing potential is applied. A 1-mfd. condenser C_{19} , however, is connected between the lower end of this resistance and the cathode, while a further 2-mfd. condenser C_{32} , is in parallel with it beneath the baseboard, giving a total capacity of 4 mfd. across the biasing resistance R_{12} of 100 ohms. This capacity is necessary in order

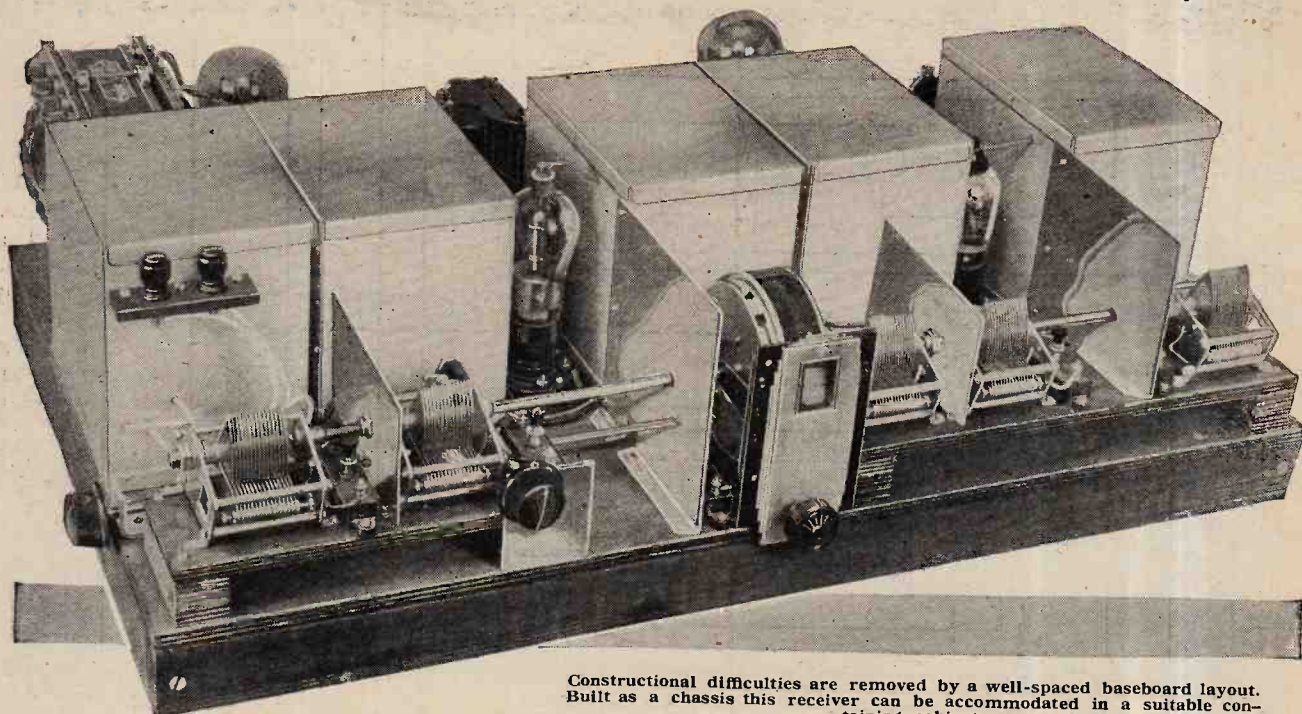

Constructional difficulties are removed by a well-spaced baseboard layout. Built as a chassis this receiver can be accommodated in a suitable containing cabinet.

capacity on the medium waveband is 0.015 mfd., and upon the long waveband 0.0075 mfd.; and, in order to simplify switching, two 0.015 mfd. condensers are used in series to give this latter value. It has been shown by the writer in a recent article³ that it is not satisfactory to rely entirely upon the band-pass filter for the preservation of high notes on the long waveband. The various circuits must, therefore, be slightly mis-tuned, and this is done automatically by the type of long wave-coil adopted. Great care has been taken to avoid coupling through a common impedance in the leads to the power supply. The screen-grid circuits have the usual 600 ohms decoupling resistances, R_2 and R_4 , with 1 mfd. condensers, C_7 and C_{18} , connected directly to the cathodes. Since the anode circuits are choked, the H.T. leads do not need decoupling, nor do they

to obtain proper operation of the volume control, and to avoid instability.

The screen-grid potential of about 55 volts is obtained from a centre tapping on the 60,000-ohms potentiometer R_5 , connected between the anode H.T. supply and the cathodes. Thus the current flowing through the H.F. biasing resistance is made up of the H.F. valves' anode current, the screen currents, the potentiometer current, and the detector anode current; totalling some 18 mA., giving an H.F. grid bias of 1.8 volts.

A power output of about 1,500 milliwatts to a suitable loud speaker represents ample volume for general use. A greater output is unnecessary for home reproduction, while a smaller output greatly increases the risk of distortion during loud passages in music. There are many ways in which an output of this order can be obtained, but for a variety of reasons preference has been given to the push-pull circuit. Perhaps the chief

³ "The Band-Pass Filter for the Long Waves," June 18th, 1930.

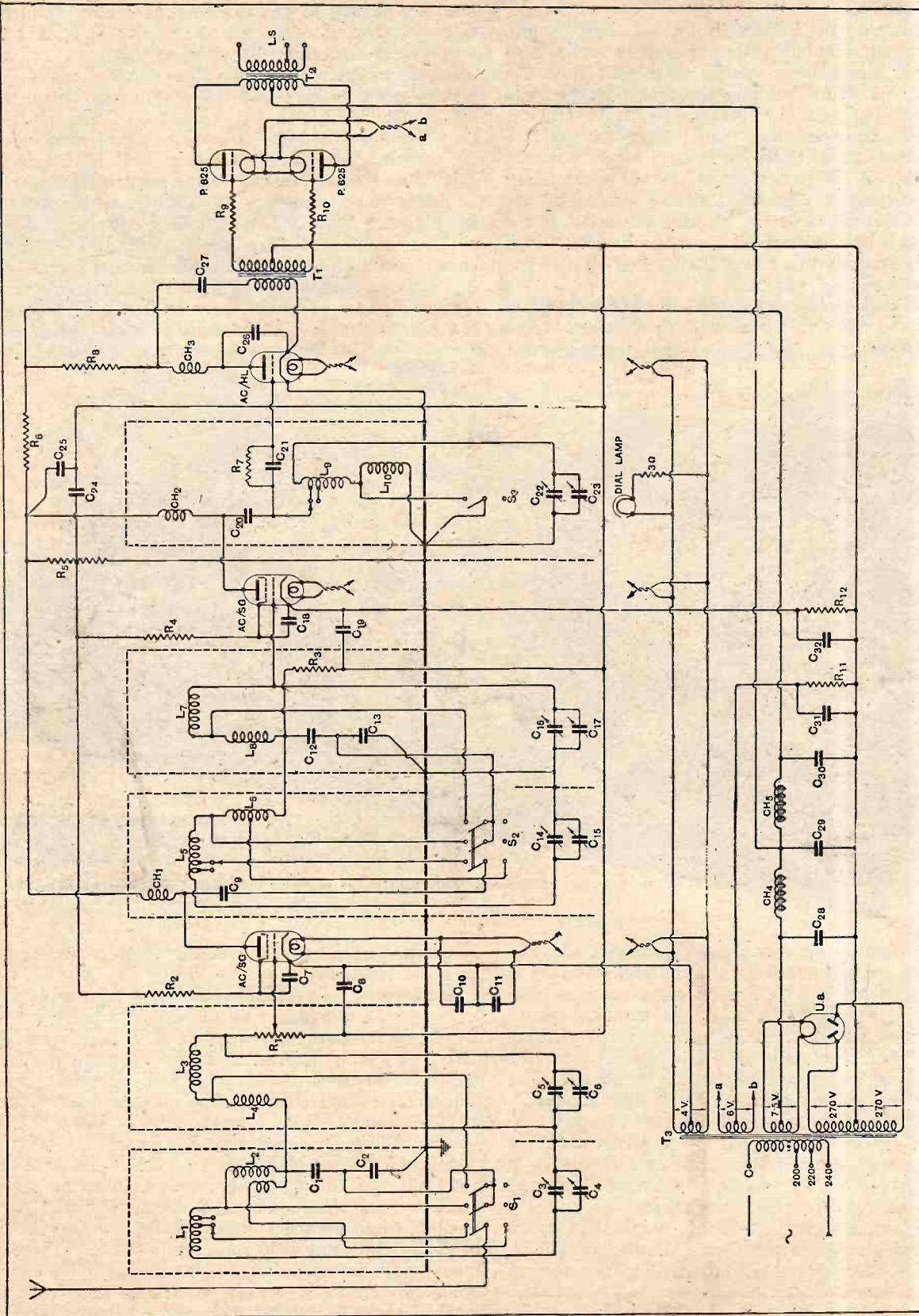

Fig. 1.—C₁, C₂, C₃, C₄, C₅, C₆, C₇, C₈, C₉, C₁₀, C₁₁, C₁₂, C₁₃, C₁₄, C₁₅, C₁₆, C₁₇, C₁₈, C₁₉, C₂₀, C₂₁, C₂₂, C₂₃, C₂₄, C₂₅, C₂₆, C₂₇, C₂₈, C₂₉, C₃₀, 1 mfd. (1,000v. test); R₁, 500,000 ohms potentiometer; R₂, R₃, 60,000 ohms, centre tapped; R₄, 10,000 ohms; R₅, 20,000 ohms; R₆, 100,000 ohms; R₇, 100 ohms; R₈, 100 ohms; R₉, 50,000 ohms; R₁₀, 100 ohms; R₁₁, 500 ohms; R₁₂, 100 ohms; CH₁, CH₂, CH₃, H.F. chokes; CH₄, smoothing choke (Ferranti B.2); CH₅, smoothing choke (Ferranti B.1); T₁, push-pull transformer A.F.5c; T₂, output transformer O.P.M.1c; T₃, mains transformer; L₁, L₂, L₃, L₄, L₅, L₆, L₇, L₈, L₉, medium waveband coils; L₁₀, L₁₁, L₁₂, L₁₃, L₁₄, L₁₅, L₁₆, L₁₇, L₁₈, L₁₉, long waveband coils.

The Band-Pass Four.—

advantage to be gained from its use is the almost complete elimination of feed-back from the power stage. This does away with the necessity for extensive low-frequency decoupling devices, and results in an economy in apparatus and voltages. The H.T. and grid-bias supplies need but little smoothing, as hum is balanced out in the push-pull stage; while distortion is less evident owing to the reduction in second harmonics and the absence of a magnetising direct current through the output transformer. The sole disadvantage of push-pull is a tendency towards self-oscillation at a super-sonic frequency with certain valves. This is not serious, however, for it can be cured by the insertion of a 100,000-ohms resistance R_9 and R_{10} in series with the grid lead of each valve.

Two Marconi or Osram P.625 valves are used with about 220 volts H.T., the grid bias of 22 volts being

push-pull stage is some 5,000 ohms. The maximum input needed fully to load this power stage is about 42 volts peak; accordingly, the detector and its L.F. coupling must be so designed that this L.F. voltage is just obtained with a fully modulated H.F. input of normal strength.

Power grid detection,⁵ with an A.C./H.L. valve, has been chosen, since it offers the greatest freedom from distortion, while being also the most sensitive method of rectification. It is undesirable to pass the detector anode current through the primary winding of a transformer, owing to its large value. The transformer, a Ferranti A.F.5c, is, therefore, fed through a resistance condenser combination of a 20,000-ohms coupling resistance R_8 and a 2-mfd. condenser C_{27} . A 0.002-mfd. by-pass condenser C_{26} , and an H.F. choke CH_3 , complete the intervalve coupling. The transformer has a ratio of 3.5 to 1, so that 12 volts peak are necessary

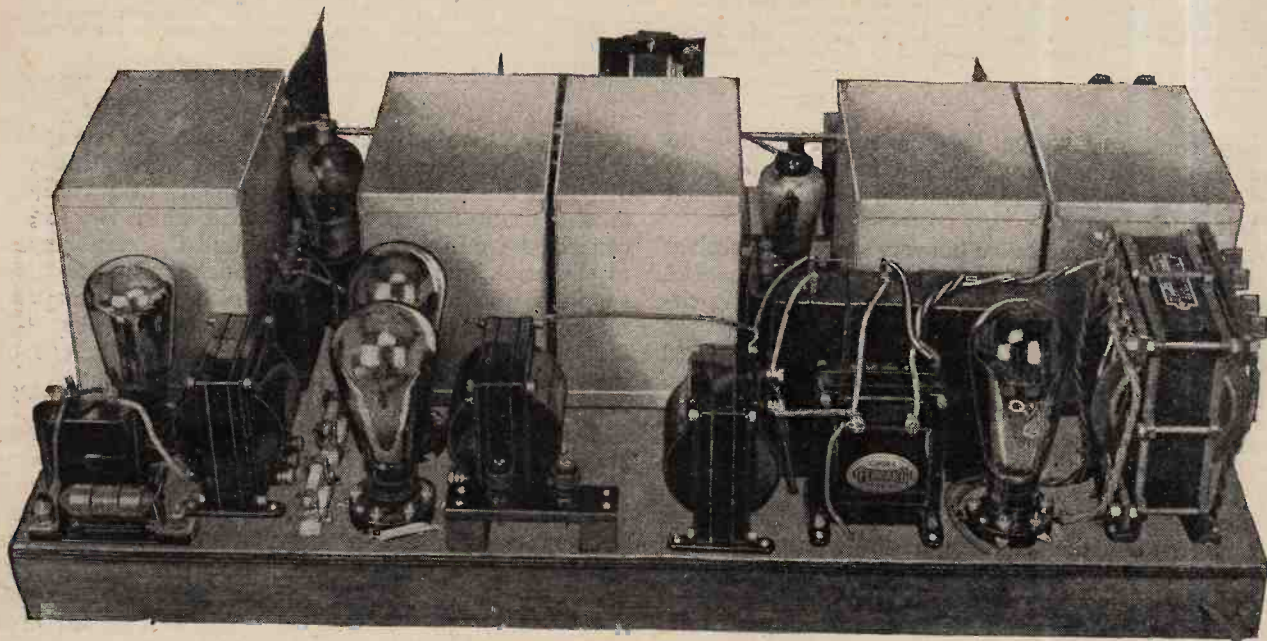

Rear view showing the rectifier and smoothing equipment together with the push-pull output stage.

obtained by the voltage drop across the 500-ohms resistance R_{11} , in the negative H.T. lead. Grid-circuit decoupling is rendered unnecessary by push-pull, but for safety's sake this resistance is shunted by a 2-mfd. condenser C_{31} . The output transformer is a Ferranti O.P.M.1c, allowing the choice of three different ratios—1 to 1, 1.6 to 1, and 2.7 to 1. The 1.6 to 1 ratio is usually the most suitable, but care should be taken to choose by experiment the best ratio for the speaker used. Of course, if a low-resistance, moving-coil speaker be employed, it will be necessary to substitute a different transformer with a suitable ratio. The correct ratio can easily be calculated by the method given in a recent article on the subject;⁴ it must be remembered, however, that the output impedance of the

across the primary winding fully to load the power stage. This will be obtained from a 100 per cent. modulated input to the detector, when the anode current change is 0.6 mA. Many stations, however, do not modulate so deeply as this, and it becomes necessary to allow for a greater change of anode current. The A.C./H.L. valve, with the voltages used in this set, will rectify distortionlessly provided that the change of anode current does not become greater than 1.2 mA.; it will be seen, therefore, that the output stage can be fully loaded on a signal which is only 50 per cent. modulated. The normal steady anode current is 6.5 mA. The grid leak R_7 and condenser C_{21} have values of 0.15 meg. and 0.0001 mfd. respectively, allowing the retention of high notes up to about 8,000 cycles. The

⁴ "Matching Valve and Loud Speaker," by A. L. M. Sowerby, May 28, 1930.

⁵ See "Power Grid Detection," by the author, May 7, 1930.

THE BAND PASS FOUR.

LIST OF PARTS USED.

- | | |
|--|---|
| <p>5 Log. law variable condensers, 0.0005 mfd. for ganging (Polar Universal).</p> <p>6 Balancing condensers, 0.00005—0.0001 mfd. (Formo Type F).</p> <p>1 Drum dial (Rotherma National Rainbow).</p> <p>1 Potentiometer, 500,000 ohms (Rothermel "Centralab").</p> <p>1 Condenser, 4 mfd., 1,000 volts D.C. test (T.C.C. Type No. 95).</p> <p>2 Condensers, 2 mfd., 1,000 volts D.C. test (T.C.C. Type No. 95).</p> <p>5 Condensers, 2 mfd., 600 volts D.C. test (Ferranti Type C2).</p> <p>3 Double 1 mfd. condensers, 500 volts, D.C. test (Ferranti Type C2e).</p> <p>1 Condenser, 0.002 mfd. (T.C.C. Type No. 34).</p> <p>2 Condensers, 0.0005 mfd. (T.C.C. Type No. 34).</p> <p>1 Condenser, 0.0001 mfd. (T.C.C. Type No. 34), with clip.</p> <p>4 Condensers, 0.015 mfd. mica (T.C.C. Type No. 34).</p> <p>3 H.F. Chokes (McMichael Binocular Junior).</p> <p>2 Grid leaks, 100,000 ohms (Ediswan).</p> <p>1 Grid leak, 150,000 ohms (Ediswan).</p> <p>1 Grid leak, 500,000 ohms (Ediswan).</p> <p>3 Porcelain grid-leak holders (Competa).</p> <p>1 Wire wound resistance, 10,000 ohms (Colvern Colverstat).</p> <p>1 Wire wound resistance, 60,000 ohms, tapped at 30,000 ohms (Colvern Colverstat).</p> <p>1 Wire wound resistance, 500 ohms (Colvern Colverstat).</p> <p>1 Wire wound resistance, 100 ohms (Colvern Colverstat).</p> | <p>1 Wire wound resistance and holder, 20,000 ohms (Dubilier Duwirohm).</p> <p>1 Push-pull interval transformer (Ferranti A.P.5c).</p> <p>1 Push-pull output transformer (Ferranti O.P.M.1c).</p> <p>1 Smoothing choke (Ferranti B.1).</p> <p>1 Smoothing choke (Ferranti B.2).</p> <p>1 Mains transformer (Rich & Bundy, Type 34). State voltage and frequency.</p> <p>6 Valve holders, 5-pin (Benjamin).</p> <p>4 Ebonite shrouded terminals (Belling-Lee.)</p> <p>5 Aluminium screening boxes, 4½ × 6½ × 6 (Magnum).</p> <p>1 Baseboard, 29in. × 13in.</p> <p>2 Switches, 3-pole (Utility Type 190/3).</p> <p>1 Switch, 1-pole (Utility Type W.190/1).</p> <p>2 Decoupling resistances, 600 ohms (Wearite).</p> <p>1 Arrow knob, 1½in. diameter.</p> <p>3 Lengths of silver steel, 13in. × ¼in.</p> <p>2 ft. steel strip, 3/32in. × ¼in.</p> <p>2 Coil formers, 2in. dia. × 3in. long ebonite.</p> <p>5 Long-wave coil formers, or quantity ¼in. ebonite sheet.</p> <p>Quantity No. 28 D.S.C. and No. 36 D.S.C. wire.</p> <p>Quantity No. 20 tinned copper wire, insulating sleeving, screws, wood, nuts, bolts, sheet aluminium, 2 B. A. rod, soldering tags, etc.</p> <p>Approximate cost (excluding valves), £22.</p> |
|--|---|

In the "List of Parts" included in the descriptions of THE WIRELESS WORLD receivers are detailed the components used by the designer, and illustrated in the photographs of the instrument. Where the designer considers it necessary that particular components should be used in preference to others, these components are mentioned in the article itself. In all other cases the constructor can use his discretion as to the choice of components, provided they are of equal quality to those listed and that he takes into consideration in the dimensions and layout of the set any variations in the size of alternative components he may use.

by-pass condenser is not large enough to cause an appreciable high-note loss, while it is sufficiently large to give a very considerable reduction in the grid circuit damping.

When care has been taken in every stage of a receiver to obtain even amplification of all audible frequencies from the lowest to the highest, the H.T. smoothing circuits become of the utmost importance. It is of little use having good bass reproduction if this be marred by an audible hum. The smoothing circuit, therefore, is a little unusual, and the reduction of hum is progressive. It is obvious that the H.T. supply to the power stage need not be so free from hum as that for the H.F. stages, as a large amount of amplification follows the latter valves. It will be seen that the whole H.T. current for the set, some 62 mA., passes through the first choke CH₄, which is a Ferranti B.2, and is smoothed only to the degree required by the output stage. The detector and H.F. current requires still further smoothing, so it is passed through the second choke CH₅, which is a Ferranti B.1, and is smoothed to the degree necessary to eliminate hum from the detector stage. The current for the H.F. stages is still further smoothed by passing through the voltage-dropping resistance R₆ of 10,000 ohms. By graduating the smoothing in this manner, it is possible to obtain a really hum-free supply of current with a minimum of apparatus. A word of warning should be given, however, against using the particular circuit shown in any receiver not employing push-pull. Unless push-pull be used, difficulty may be found in eliminating motor boating; with push-pull the circuit is perhaps more satisfactory than any other.

A U.8 valve is used for rectifying the H.T. current, and with the 270-0-270 volts transformer winding it gives an unsmoothed rectified output of about 256 volts at 62 mA. across the 4-mfd. condenser C₂₈. A 7.5-volt centre-tapped winding supplies 2.4 amperes for the U.8 filament; while a 6-volt centre-tapped winding sup-

plies 0.5 ampere only for the filaments of the two P.625 valves. The three indirectly heated valves and the dial light are supplied with 3.5 amperes at 4 volts by another centre-tapped winding, across which two series-connected 1-mfd. condensers, C₁₀ and C₁₁, are shunted to eliminate hum due to H.F. modulation. The lamp supplied with the drum dial, which is of American origin, is rated to consume 0.5 ampere at 2.5 volts; it is necessary, therefore, to connect in series with one of the leads to it a 3-ohms resistance. Alternatively, of course, a lamp rated at 4 volts may be substituted.

The principles underlying the design of the receiver should now be clear, and a full discussion of these principles will be found in the various articles to which reference has been made. In this receiver the recent developments in tuning and H.F. circuit design are represented in a practical form, while the use of power-grid detection, push-pull output, and an unusual smoothing circuit, has resulted in greater freedom from distortion and hum.

The constructional details of the coils can clearly be seen from the drawings of Fig. 2; the medium-wave windings consist of 58 turns of No. 28 D.S.C. wire on a 2in. diameter ebonite former, all coils being wound in the same direction. The aerial coil (L₁, Fig. 1) has windings taken at 10 and 15 turns from the low-potential end, while the two anode coils (L₅, L₆) have windings at 29 and 40 turns from the low-potential end. The two coils, which are mounted vertically, are secured by small metal brackets to blocks of wood fastened to the baseboards; while the three horizontally mounted coils are each supported on two lengths of 2 B.A. rod passed through each end of the coil formers with a nut on each side. The ends of the rods are passed through two holes in the baseboard and secured by a nut on each side. It is, of course, necessary to raise the baseboards some ¾in. by two small battens on the undersides.

The long-wave coil formers can readily be constructed from some ¼in. sheet ebonite with the aid of a disc

The Band-Pass Four.—

cutter. Each consists of a disc of ebonite $1\frac{3}{16}$ in. diameter assembled between two discs 2 in. diameter, and held together by two 6 B.A. bolts through the centre piece. One of these bolts can form the terminal for the inside of the winding, while it is necessary to insert countersunk head 6 B.A. bolts through one of the side pieces to form the terminals for the outer end of the winding and any tapings. The holes for these bolts must be deeply countersunk on the inside to prevent the wire from coming into contact with the terminal. The main winding on each coil consists of 175 turns of No. 36 D.S.C. wire, all coils being wound in the same direction. The aerial coil L_2 has a further 44 turns of the same wire wound directly outside the main winding and in the same direction. The anode coil of the first H.F. valve L_6 is tapped at 74 turns from the inside of the winding. It should be noted that, with the exception of this tapped coil L_6 , all the coils are connected in circuit in the same direction; that is,

the outside end of the winding is the low-potential end. The anode coil L_6 , however, has its connections reversed, and the inside end of the winding is the low-potential end.

Further constructional details and operating notes will be included in next week's issue. The receiver is available for inspection by readers at the offices of this journal, 116, Fleet Street, London, E.C.4.

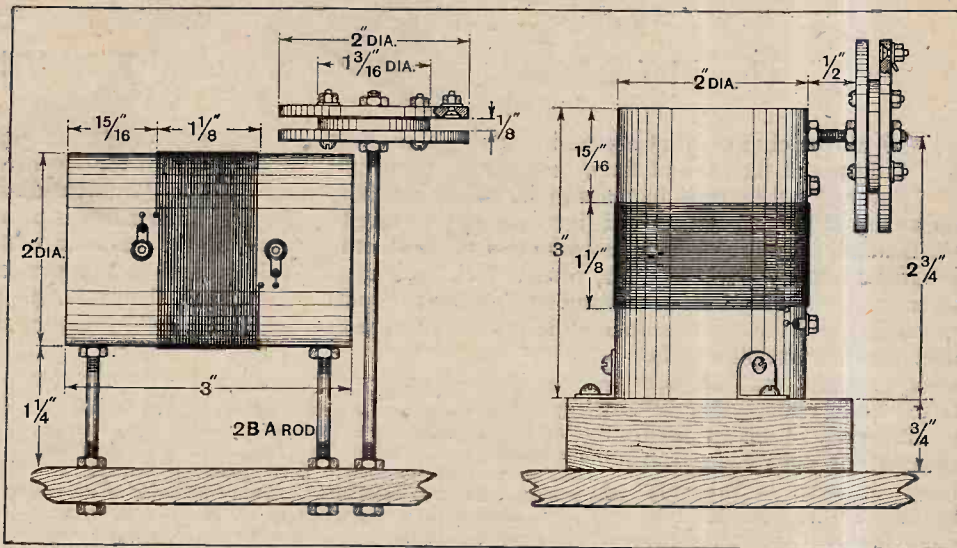

Fig. 2.—Dimensional drawings showing the construction and mounting of the coils. Medium band 58 turns of No. 28 D.S.C. tapped at 29 and 40 turns in respect of two of the coils and at 10 and 15 turns in the other case. Long-wave coils consist of 175 turns of No. 36 D.S.C. One coil has 44 turns outside the main winding and the other is tapped at 74 turns from the inside of the winding. Five long-wave coil formers are required.

EMPIRE BROADCASTING.

IN view of the fact that Empire broadcasting is now under consideration at the Colonial Conference, we feel that all our readers will be interested in the following letter, reprinted from *The Times* of June 16th:—

TO THE EDITOR OF *The Times*.

Sir,—Has not the time come when a big step forward should be taken in Empire broadcasting?

Two-and-a-half years ago the long-range wireless station 5SW was established by the British Broadcasting Corporation. 5SW transmits for a few hours a week, and is heard occasionally in many parts of the Empire. 5SW is a link, but, I think, an inadequate one. At various times the B.B.C. have resisted proposals that they should develop this skeleton service on two grounds: (1) That a regular service could not be guaranteed for technical reasons; and (2) even if it was technically possible, the B.B.C. could not, and ought not to, be asked to provide the money.

Much research work has taken place in the last two years, and it is plain that a great technical advance has been made. I have reason to think that the B.B.C. consider that a 24-hour programme, which would give fair, if not good, reception in most parts of the Empire most of the time, is now practicable. If this is so, the question of finance would appear to be the only one now requiring solution.

There are in the Empire outside the United Kingdom three classes of potential listeners to British programmes:—

(1) The residents in the Dominions. They have, particularly in the larger Dominions, well-organised broadcasting systems, and adequate local talent. Their need for British programmes is accordingly slight, but that the need—particularly on Imperial or special occasions—is real, I am convinced.

(2) The residents in self-governing Colonies and similar developed societies where there is a sufficient aggregation of population to justify the erection of local transmitters—Southern Rhodesia, for example. These

Colonies necessarily have little local talent, and would accordingly relay British programmes very considerably.

(3) The lonely Briton, miles from anywhere. He would require to receive the programmes direct from England. It ought not, however, to be impossible for him to do this satisfactorily with modern and fairly inexpensive apparatus.

It might be argued that, if the classes of persons I have enumerated want to hear British programmes, they should pay for them. I do not doubt that in time they would be found willing to do this, but at first it seems to me that the whole or the greater part of the burden must fall on the Mother Country. If at the forthcoming Colonial Conference the British Post Office makes a specific proposal to pay, say, half the cost of starting and running the service for an experimental period of, say, two years, is it not possible that the Colonial Governments will pay the other half? The British Post Office diverts £400,000 a year of the licence fees at present, and ought not, I think, to be unwilling to devote a small proportion of this amount to such an Imperial purpose.

But, whether the Mother Country has to pay the whole or part, my plea is that the service should be instituted forthwith. At present the remote Briton listens as much to Dutch and American stations as to 5SW. This is not good for British prestige nor for British trade. The money—probably something between £20,000 and £50,000 a year—would be spent in Britain in any event, and, apart from Imperial and sentimental considerations, the expenditure probably would be indirectly repaid in the supply of wireless receivers, local transmitters, etc. The present Government certainly ought to take the present opportunity, and I beg leave to commend the suggestion to you, Sir, and to Mr. Thomas.

Yours faithfully,
IAN FRASER.

St. John's Lodge, Regent's Park, N.W.1.

A Powerful OUTPUT VALVE FOR 200 VOLTS

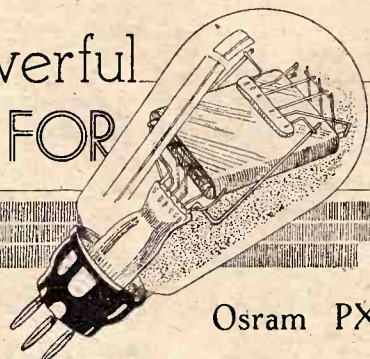

The Marconi and Osram PX4 Valve Tested.

OF all the changes that are taking place in receiver design at the present time, perhaps the most universal is the steady increase in the power-handling capacities of the last stage. This increase may be due to the demand for more realistic reproduction of music, or to the inevitable comparisons made when a pick-up is used in conjunction with a set possessing an "ordinary" output stage, and the volume obtainable is contrasted with that from a gramophone. To some extent it may be due to the quite unnecessary insensitiveness of many loud speakers of the moving-coil type, or even to the very human desire to impress one's friends. Whatever the cause, the effect is the same; every user of a loud speaker would like to replace his present output valve with a new one capable of making just a little extra noise before distortion sets in.

IN this review special attention has been given to perhaps the most essential characteristic of an output valve, namely, the maximum undistorted power output in A.C. watts that will be available to work a loud speaker of suitable impedance. For this calculation use must be made of anode-volts/anode-current curves which, we are glad to note, are now being supplied in the valve cartons by certain makers. The general publication of such curves was strongly advocated in the pages of this journal in December last. The rapid determination of output is rendered comparatively simple by the aid of a special five per cent. distortion scale.

The PX4 valve is capable of handling considerably more power than the average output valve, while still being content with quite an average anode voltage; it should therefore be of very special interest to a large number of readers.

The valve has a large bulb, heavily "gettered," within which can be seen a sturdily built anode of the familiar flattened shape, inclined at an angle. The filament consumes 0.6 ampere at 4 volts, and is of the coated type that glows a dull red in operation. The characteristics of the valve, as given by the makers, are:—

- Amplification factor,* 3.8.
- Impedance,* 1,450 ohms.
- Mutual conductance,* 2.6 milliamps. per volt.
- Maximum anode volts, 200.
- Anode dissipation, 10 watts maximum.

* Taken about $E_a = 100$, $E_g = 0$.

The results of our own measurements on one of these valves are given in the curves accompanying this review, and in the table. It is especially to be noted that the values for A.C. resistance (impedance) and mutual conductance given in the diagrams refer to working conditions. It is usual for figures taken for working conditions to be less good than those quoted by the makers; in the present case, owing to the large anode current drawn by the valve, the difference is trifling.

Fig. 1 shows the curves connecting grid voltage and anode current for several selected values of anode voltage; these "mutual-conductance curves" (so called because their slope is a measure of the mutual conductance of the valve) are those normally issued with all valves, and so are perfectly familiar to everyone. In Fig. 2 are shown "A.C. resistance curves," giving the relation between anode current and anode voltage at a series of different grid voltages. These curves, though perhaps less familiar than those of Fig. 1, are enormously more valuable to the users of the valve, and are, in fact, the curves from which the best operating conditions have to be derived by the designer of the valve before he composes his little slip of paper giving instructions for their use.

Comment has previously been made in these pages¹ upon the absence of these curves from the instruction sheets issued by the various makers. We are therefore very glad indeed to learn that the leaflets that will accompany the PX4 and all other output valves issued under the Marconi and Osram name will contain impedance curves, so that the correct operating conditions for circuits of all types can be determined by the users, and we venture to hope that the provision of these more useful curves will eventually be universal. Speaking for ourselves, we are heartily tired of redrawing curves in this form for our own purposes, especially as the usual grid-volts/anode-current curves do not run up to a high enough voltage (nearly double the working voltage is

¹ "Grid-bias Values," by W. I. G. Page: *The Wireless World*, Dec. 18, 1929, p. 666.

MARCONI AND OSRAM PX4. (Average for 2 valves)

Filament Volts	4.0	Maximum Anode Volts ..	200
Filament Amps	0.6	Optimum Grid Bias	-32½ v
A.C. Resistance* ..	1,350 ohms	Anode Current	33mA.
Amplification Factor* ..	3.45	Maximum A.C. Output	1,020 milliwatts
Mutual Conductance*	2.55 mA./volt	Maximum Anode	
Optimum Anode Load	3,000 ohms	Dissipation ..	10 watts

* Under working conditions.

A Powerful Output Valve for 200 volts.—

required), with the result that about 50 per cent. of our redrawn curves have been sheer guesswork.

Reverting to Fig. 2, it will be seen that the optimum anode-circuit load comes out in the present case to 3,000 ohms. The line corresponding to this value of load is drawn across the diagram ("load-line"), and from the intersection of this line with the various curves the complete dynamic characteristic, showing the changes in

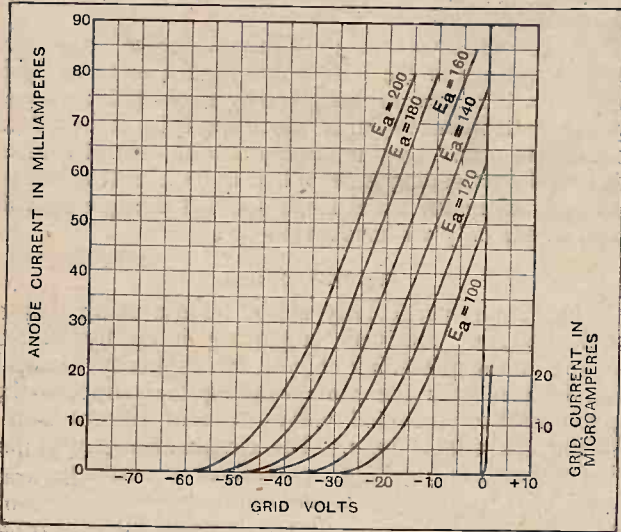

Fig. 1.—Grid-volts/anode-current curves of the PX4 valve. Note that grid current does not flow at negative grid voltages.

anode current and anode voltages resulting when a signal is applied to the grid of the valve, can immediately be read off. The curve marked "10-watt line" that intersects all the valve curves marks the highest current that can be taken from the valve at any plate voltage; it will be seen that with the correct load of 3,000 ohms the wattage dissipation indicated by this line is not exceeded at any part of the grid swing.

Most moving-armature speakers, and many of the high-resistance moving-coil speakers, have an impedance rather higher than the 3,000 ohms required for this valve; in consequence, a slight accentuation of the bass register may be expected when using the PX4.

The Five per Cent. Distortion Scale Explained.

Since the effective impedance of two valves in push-pull is double that of either valve alone, it has in the past been rather difficult to find a valve with low enough impedance to work well in this circuit. The PX4 is well fitted for this purpose, since the combined impedance of the two (some 3,000 ohms) would be almost exactly that for which the average loud speaker is designed. With PX4 valves the disconcerting discovery that the removal of one valve from its socket makes no alteration to the output volume would not be made. When this is found it can always be traced down to improper impedance relationships between valves and speaker.

With the output load mentioned, the valve requires a grid bias of 32½ volts when 200 volts are used on the anode; the plate current is then 33 milliamps. An out-

put of just a shade over 1,000 milliwatts is available under these conditions, accepting the usual 5 per cent. of second harmonic as the limiting factor. This result, together with the choice of the optimum resistance for the output circuit, has been obtained graphically from Fig. 2. For this purpose use was made of the special "5 per cent. distortion scale" on celluloid, reviewed elsewhere in this issue, and it was found that the work was considerably facilitated by its use. From Fig. 2, where the construction for the optimum conditions is shown, the method adopted can readily be followed.

A likely value of grid bias is chosen (here 32½ volts), and with the centre of the scale on the point 0, representing the corresponding anode current at the maximum anode voltage, the scale is swung round until the curves $E_g = 0$ and $E_g = 65$ (this latter figure being double the steady bias) cut the scale at "equal distances" from the centre. The special graduation of the scale, in which an "inch" to the right is only 9/11ths as long as an "inch" to the left, provides that the second harmonic distortion shall amount to 5 per cent. The anode voltages and anode currents corresponding to the intersection of the scale with the two curves mentioned is then read off, these being the maximum and minimum anode voltages and currents attained when the grid is swung from zero to twice the bias voltage by the applied signal. The total anode-voltage swing is from C to B, which is 158 volts, the peak value is $\frac{158}{2}$ volts, and the R.M.S.

value $\frac{158}{2\sqrt{2}}$ volts. Similarly, the total anode-current swing is AC, or 51.8 milliamps., and the R.M.S. current $\frac{51.8}{2\sqrt{2}}$ milliamps. The product of current and voltage, $\frac{158 \times 51.8}{8} = 1,020$, is the A.C. output in milliwatts

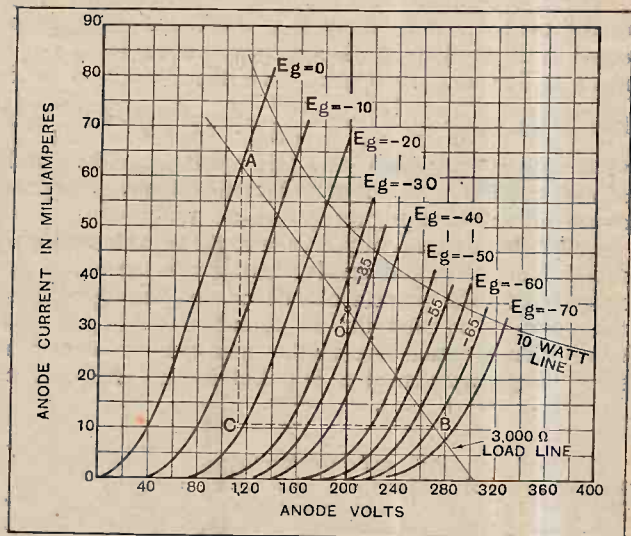

Fig. 2.—Anode-volts/anode-current curves. With these it is possible to determine the optimum grid bias, the most suitable loud speaker impedance and the maximum undistorted A.C. output. At A, I_{max} is 62.1 mA. and E_{min} 113 volts. At B, I_{min} is 10.3 mA. and E_{max} 271 volts.

² See "Valve Data," *The Wireless World*, Dec. 4th, 1929.

A Powerful Output Valve for 200 volts.—

obtainable from the valve. This is also equal to $\frac{AC \times BC}{8}$, or one-quarter of the area of the power triangle ABC.

The available power was worked out in the same way for grid-bias values of 30 and 35 volts; it came out at 935 and 960 milliwatts respectively for the two cases,

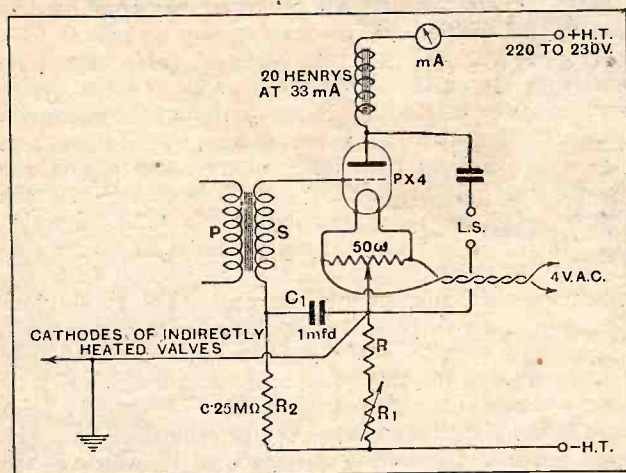

FIG. 3.—Mode of connecting the PX4 in an all-mains A.C. receiver. The bias resistance can be conveniently made up of a fixed resistance R in series with a variable resistance R₁. The total value of the two resistances should be $\frac{35,500}{I}$ ohms, where I is the total anode current of the receiver in mA. If I is 60 milliamps, R could be 400 ohms and R₁ 200 ohms. Note the decoupling components R₂ and C₁.

thereby showing that there was a falling-off on either side of the $32\frac{1}{2}$ volts for which the construction is shown in Fig. 2.

The anode-circuit load required is given by the slope of the load-line AB; there is a difference of potential equal to BC (158 volts) when a current equal to AC (51.8 mA.) is flowing. By Ohm's Law the resistance therefore has a value of $\frac{BC}{AC}$ or $\frac{158}{51.8} = 3.05$. Since BC is in volts and AC in milliamps., this result is in thousands of ohms, so that the required load-resistance is 3,050 ohms, or, in round figures, 3,000 ohms.

This determination of power output and optimum load sounds very long and involved, but with the aid of the special scale the process can be carried through in less time than is needed for an attentive reading of the description given. The matter has been gone into at some length because it is felt that as the sole duty of

an output valve is that of providing power to operate the loud speaker, the determination of the available power is by far the most essential point in any review of an output valve. It is pleasant to know that a valve will give its maximum output of power in return for a small signal voltage, or that it is economical in filament or anode-circuit consumption, but it is absolutely essential to a sane comparison of output valves to know exactly the extent to which they will fulfil their primary function of handing a loud and undistorted signal to the loud speaker.

Using a sensitive speaker of the moving-coil type, the output wattage of the PX4 valve is such as to imply a volume not far short of that given by a good gramophone, with a perfection of quality which the PX4 at least does nothing to mar. Very much more noise can, of course, be had if overloading is permitted to the extent to which it is carried in the usual small set, but the quality will then please only an uneducated ear.

For D.C. Mains.

The PX4 is particularly suited for use as an output valve in A.C. receivers employing indirectly heated valves in the preceding stages, for its heavy filament can be run from the same winding that supplies the 4-volt indirectly heated valves without risk of introducing appreciable hum. The circuit arrangement for this is shown in Fig. 3, the potentiometer across the filament being adjusted until the hum vanishes. The bias must be increased³ by about 3 volts if this mode of lighting the valve be adopted; the value given for the bias resistance takes this into account. If a milliammeter is to hand, the bias resistance should be varied by adjusting R₁ until the correct anode current is obtained, so that variations between one valve and another may be compensated.

The PX4 is a very attractive valve for the user of D.C. mains who finds his ambitions rather seriously thwarted by the fact that the maximum voltage available is rather on the low side for "life-size" reproduction. It is built especially to work on the voltages attainable from D.C. mains, and so should be regarded as the solution of the voltage difficulty for those who are desirous of handling a large power on a voltage which cannot be persuaded to exceed 200. Many a user of A.C. mains will also choose this valve if he is already in possession of an eliminator giving voltages of about this value, though he should be careful that the high current demanded by the valve does not saturate his smoothing chokes, and so introduce hum.

³ "Grid-bias Values," *The Wireless World*, Dec. 18, 1929, p. 666.

Electrical Wiring and Contracting.
Edited by H. Marryat, M.I.E.E.,
M.I.Mech.E. Vol. V, comprising Heating
and Cooking, Converting Plant,
Transformers, Rotary Converters, Recti-
fiers, etc., Electric Bells, Alarm and Clock
Systems. Pp. 237+VII, with numer-
ous illustrations and diagrams. Pub-
lished by Sir Isaac Pitman and Sons,
Ltd., London, price 6s. net.

BOOKS RECEIVED.

Technik und Aufgaben des Fernsehens,
by F. W. Winckel.—A short account of
the methods and apparatus used in vari-
ous systems of phototelegraphy and tele-
vision. Pp. 74, with 65 illustrations and
diagrams. Published by Rothgiesser und
Diesing A.G., Berlin. Price RM.2.

Manuel de Reception Radio-Electrique,
by P. David.—A text-book for students
and amateur constructors, comprising
chapters on the Propagation of Waves,
Aerials, Selectivity, Amplification, Re-
action, Detection, Super-regeneration
and various types of wireless receivers.
Pp. 308, with 152 illustrations and dia-
grams. Published by Masson et Cie,
Paris. Price Fr.36.



News of the Week

in Brief Review.

THE RED WAVE.

When feeling "blue," listeners should tune their sets to 938 metres, which, according to the Soviet journal, *Projector*, is known as "the Red Wave" and is "unexpectedly popular in many parts of the world." It is the wavelength of Moscow (Trades Unions).

o o o o

THAT AERIAL PROBLEM.

Poorly erected and unsightly wireless aerial poles are banned on the Bristol Corporation housing estate. To prevent damage to house property, tenants must submit aerial designs to the housing committee.

The increased popularity of the portable set and the widespread use of H.F. stages will soon render such regulations unnecessary.

o o o o

HOW TO SELL LICENCES.

Wireless "pirates" are famous for their resourcefulness when magistrates demand explanations of their conduct. A recent offender at Alnwick gave as the reason for his default the distance of the Post Office from his house.

Such hardship would be avoided if P.O. licence clerks were to patrol the country on tricycles bearing the familiar legend, "Stop me and buy one."

o o o o

TALKS WITH TOKYO?

We understand that short-wave tests between Germany and Japan are now being conducted by the Telefunken Company with a view to the establishment of a public telephone service. If such a service materialised, the British Post Office would arrange with the German authorities for linking up the service with the Transatlantic Telephone system, thus permitting America to converse with Japan *via* the eastward route.

o o o o

EUROPEAN RADIO "RADIANCE."

The kilowatt method of comparing the broadcasting activity of European nations gave a Paris audience food for thought a few days ago, when Commandant Brenot, the well-known radio authority, placed France bottom in a list of European countries compared as regards the total kilowatt power of their broadcasting stations.

At the end of the year, according to Commandant Brenot, Germany will be radiating 535 kilowatts; Britain, 470; Russia, 222; Poland, 174; Sweden, 120; Czecho-Slovakia, 107; and France, 64.

B 15

SOFTLY, PLEASE.

The answer to the problem: "When is a loud speaker not a loud speaker?" is: "When it is used at Le Raincy, Seine-et-Oise, France." The Mayor of Le Raincy has forbidden the use of any loud speaker, private or otherwise, which can be heard anywhere in the street.

o o o o

A CHALLENGE TO THE B.B.C.

Our Paris correspondent states that France's "national radio reporter" boasts that he can speak for three hours continuously on any subject without fatiguing his listeners. This gentleman deserves an introduction to the Savoy Hill Talks Department.

o o o o

NEW GERMAN TELEVISION TESTS.

Television experimenters who receive the daily tests from Witzleben, Germany, will be interested to learn that arrangements have been completed for similar tests from Koenigswusterhausen, which employs a power of 26 kW. as compared with 1½ kW. of Witzleben. The present experiments are carried out from 9 to 9.30 a.m. and 1 to 1.30 p.m., except on Tuesdays and Thursdays, but it is probable that nightly tests after broadcasting hours will soon be inaugurated.

ITALY'S LINK WITH SARDINIA.

Italy and Sardinia are to be linked together by a new wireless telephone service, a transmitter for this purpose being in course of erection at Golfo Aranco. There is no cable communication between the countries.

o o o o

WIRELESS LESSONS FOR MUSIC DEALERS.

A ten days' radio and radio-gramophone course for members of music trade associations is to be held from July 7th to 18th at the Music Trades School, Holloway Road, N.7. The proposed fee is two guineas for the course, which will be restricted to members of the associations. The course has the support of several important wireless firms.

o o o o

WHERE WIRELESS LICENCES ARE RESENTED.

The tax on radio sets recently instituted by the South Carolina Legislature and reported in our issue of June 11th last, has raised a storm of protest, led by Judge John W. Van Allen, general counsel of the U.S. Radio Manufacturers' Association.

"Are we, as a nation," asks the Judge, "plunging headlong into a community of petty taxes, costing more to collect and administer than is received from them, like some European nations? Is a radio



THE "BRITANNIC" TRIALS. On Saturday next, June 28th, listeners to the National programme at 2.20 p.m. will hear a running commentary on the departure from Liverpool of the M.V. *Britannic* on her maiden voyage. The photograph shows the Marconi wireless telephone set, type Y.C.4, in use at the office of the builders, Harland and Wolff, Belfast, for communication with the *Britannic* on her recent trials.

to be compared with an automobile? Or is it more like the piano or gramophone, or other useful articles in the home?"

Our American correspondent states that the South Carolina Legislature has faced these burning questions in silence.

THE PRIZE VOICE.

"Radio's most coveted honour," according to the U.S. National Broadcasting Company, has been won this year by Alwyn E. W. Bach, an N.B.C. announcer. The award is a gold medal offered annually by the American Academy of Arts and Letters for excellence of broadcast diction.

In making the award the Academy considers proper modulation, clear enunciation, correct pronunciation, and pleasant inflection. It is stated that Mr. Bach is six feet tall and weighs 170 pounds.

FAREWELL, KWBS.

For permitting offensive language at the microphone of KWBS, Portland, Oregon, the Schaeffer Radio Company has had its broadcasting licence cancelled by the U.S. Federal Radio Commission. The charges were brought against the station by the Portland "Better Business Bureau," which alleged that Mr. Robert Duncan, a candidate for Congress, who had leased the station, referred to his opponents as "half skunks" and "yellow curs."

In publishing the decision the Commission states, incidentally, that KWBS has been a constant offender in straying off its allotted wavelength.

MONEY WANTED FOR INDIAN BROADCASTING.

Possible methods of improving Indian broadcasting and increasing the financial return were the subjects for discussion at meetings of the new Indian Central Broadcasting Advisory Committee, which opened at Simla on Monday last, June 23rd. While many bright ideas have been put forward for enriching the programmes, the difficulty is to carry them out, owing to lack of money. The Government of India has granted £20,000 for the financial year beginning April 1st last, but this sum is considered absurdly small.

We wish the Committee every success in its search for funds.

THE TRUTH ABOUT RUSSIA?

Surprise over the recent news item from Russia to the effect that Soviet listeners reached the gigantic figure of 14,000,000 is modified by perusal of the report of an interview given to the Swiss journal, "Le Radio," by Dr. Eugene Hirschfeld, a director of the Soviet radio organisation.

Apparently the figure of 14,000,000 relates to the number of listeners which it is hoped there will be in five years' time when the Soviet radio plans are completed. At present there are approximately 1,000,000 receivers in use.

Of the ultimate 14,000,000, at least 9,500,000 will be receiving their programmes by wire, "exchanges" being erected in towns where the cost of re-

ceivers to pick up the distant transmitters would be prohibitive.

There are now about sixty broadcasting and relay stations scattered over Soviet territory, according to Dr. Hirschfeld, nearly all of them being the property of the Government.

ATTACK ON RADIO ADVERTISING.

A stern warning regarding the unwholesome encroachment of advertisements in the "sponsored" broadcast programmes of America was sounded by Mr. Ernest Kauer, president of the Ceco Manufacturing Co., at the recent sixth Annual Convention of the U.S. Radio

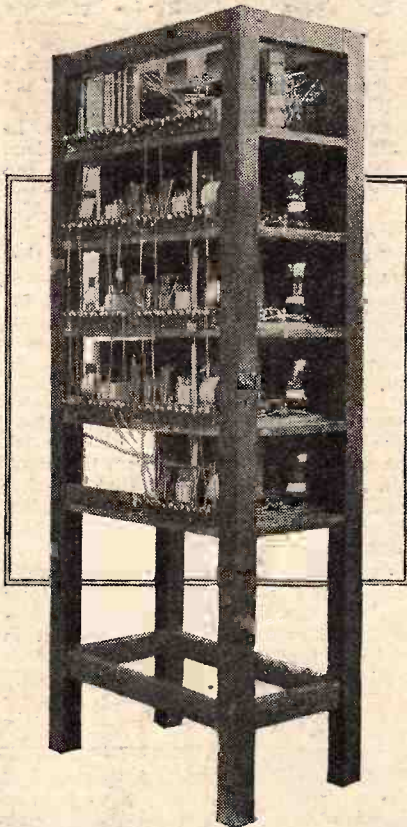

A COMPACT HOSPITAL SET. A receiver and amplifier constructed by Messrs. Gambrell Radio, Ltd., for the Ladywell Institution, London, S.E. The set serves thirty-seven loud speakers and has seventeen pentodes. All current is derived direct from a 240-volt D.C. supply.

Manufacturers' Association at Atlantic City.

"If the present situation is allowed to develop," said Mr. Kauer, "it will be much as if advertisers were allowed to dominate newspapers. A newspaper does not depend on its advertisers to secure circulation. The publisher builds his circulation by furnishing an editorial content which attracts readers.

"In broadcasting, however, the sponsor furnishes both the editorial and advertising content, so to speak, and certain sponsors of a type becoming too numerous seek to determine the pattern of broadcasting because of what they consider this double contribution."

Mr. Kauer added, says our American correspondent, that the American radio industry had lost control of broadcasting, and that if commercial control could not be lessened the public would forsake radio.

THE RADIO HUB OF AMERICA.

Twenty-seven broadcasting studios are included in the plans announced last week by a representative of John D. Rockefeller, junior, and the Radio Corporation of America for a theatre and radio centre in Manhattan, New York, to cost approximately £50,000,000.

Erected in skyscraper fashion, the building will contain four theatres wired for broadcasting, and will rise to sixty storeys in height. Several of the broadcasting studios will be three floors high and will constitute small concert halls of the type to be included in the B.B.C.'s "Broadcasting House" in Portland Place.

It is understood that the Radio Corporation of America will install experimental apparatus for television.

TRANSMITTERS' NOTES AND NEWS.

Stations in Siam.

The Royal Siamese Post and Telegraph Department at Bangkok are transmitting on 29.5 metres from their station, HS2PJ, with an aerial output of 500 watts, and on 37 metres from HS4PJ with an output of 200 watts. The first station, in addition to ordinary traffic, carries out broadcasting experiments every Sunday from 1300 to 1500 G.M.T.

5-Metre Wave Experimenters.

Mr. W. B. Crowe (G6CO) is carrying out tests from his station at 256, Ladbrooke Grove, W.10, on the 56 megacycle waveband every Sunday afternoon from 14.00 to about 16.00, in conjunction with G20W (Ealing), G20L (Ealing), G2BY (Hammersmith), and G6XN (Earl's Court), and will welcome reports of signals from any of these stations. The input of G6CO is a maximum of 10 watts to an LS5 or an AML625, which Mr. Crowe finds a very good oscillator on this high frequency.

Reports Desired.

Mr. W. Lucas, G2OI, 64, Worsley Road, Winton, Patricroft, near Manchester, asks us to state that he is working on 1715-2000kc., 7000-7300 kc., and 1400-14400 kc. C.W. and telephony, and will welcome reports, especially on variation of signal strength, tone or modulation.

New Call-signs and Stations Identified.

- G2PA W. P. Jones, 24, Maesglas Rd., Newport, Mon, transmits on 14,000 kc. waveband and will welcome reports.
- G5QE Southend and District Radio Society, Hon. Sec., F. J. Waller, 49, Fermoyle Road, Thorpe Bay. (Change of address.)
- G1200 Capt. G. C. Wilmot, Elrington Barracks, Londonderry, N. Ireland. (Change of address.) Experimenting on 10 and 20 metres and will welcome reports.
- 2BPM R. H. Johns, School House, Painscastle, Erwood, Brecknock.

SHORT
WAVE

SHIPS
TRANSMITTER

One-Valve Equipment
for Commercial
Marine Service.

OF recent years, short-wave transmission has become a feature on many of the larger mercantile vessels. By the aid of short-wave transmission these ships are able to communicate over enormous distances at least once during twenty-four hours, and hence they are able to transmit traffic which could not be cleared direct by means of the standard long-wave transmitter, with the consequent saving in cable charges.

The short-wave transmissions are carried out on wavelengths ranging from 17.5 to 48.8 metres, the shorter waves being used during the day and the longer at night. As far as the British Isles are concerned, the wavelengths licensed are 17.5 and 36.6 metres. The service with the G.P.O. station at Portishead is carried out on these wavelengths.

The general requirements of a transmitter for this type of work are robustness, compactness, and ability to stand up to sea conditions of weather and vibration. In



By
M. REED, M.Sc.

number of vessels, and which has been found to give excellent results. The circuit employed is given in Fig. 1.

It is seen that the transmitter consists of a simple Hartley circuit whose tuning capacity is C_1 . In addition there is condenser C_2 which forms a bridge circuit with the valve grid-plate capacity and the tuning inductance. An adjustment, therefore, can be made to C_2 so as to reduce the effective capacity introduced by the valve into the oscillator circuit and hence to enable the valve to oscillate at a higher frequency than would otherwise be the case. Also at very short waves, variations in the value of the grid-plate capacity would result in instability of the transmitted wave; this instability is considerably re-

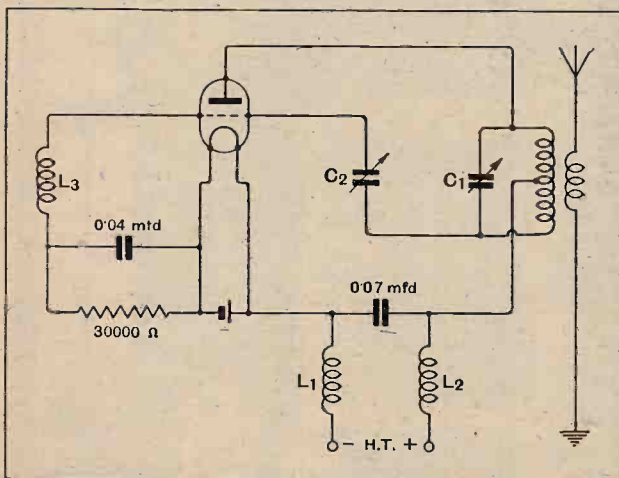

Fig. 1.—The one-valve transmitting circuit. The variable condenser C_2 serves to prevent instability due to anode-grid capacity.

addition, the operation adjustments should be fairly simple and it should be possible to adjust the wavelength quickly.

This article contains a description of a single-valve short-wave transmitter which has been installed on a

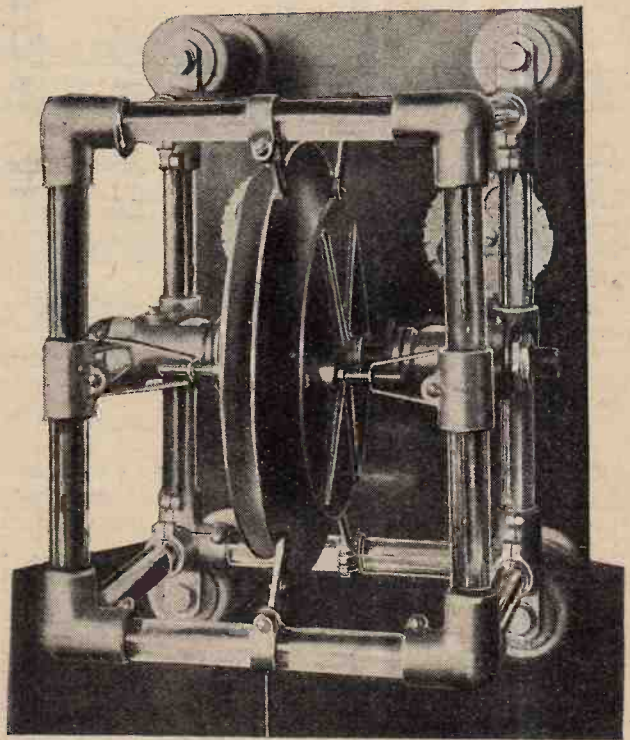

Fig. 2.—The tuning capacity showing how the sections C_1 and C_2 in Fig. 1 are combined as a three-element condenser.

Short Wave Ships Transmitter.—

duced by suitable adjustment of C_2 . To operate the transmitter it is necessary to adjust C_1 to give approximately the required wavelength. C_2 is then adjusted until a steady oscillation is obtained (as indicated by an aerial ammeter), and, finally, the value of C_1 is altered to give the exact wavelength required.

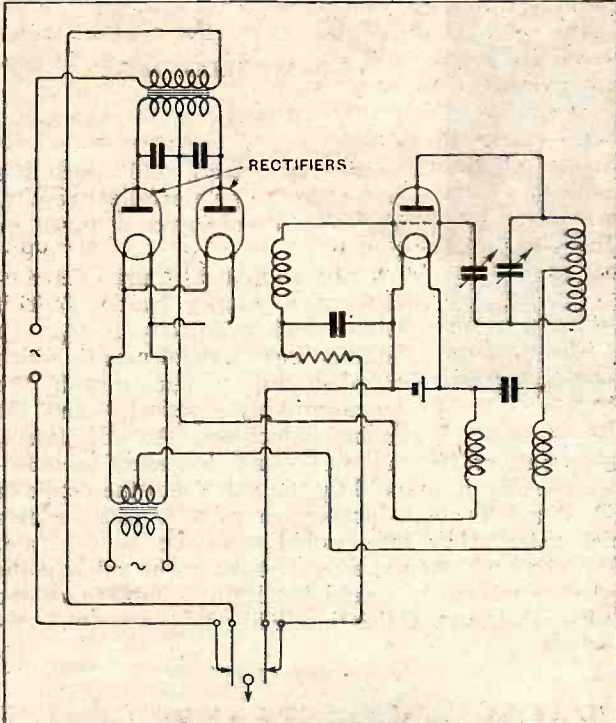

Fig. 3.—When the H.T. for the valve is supplied from rectifiers keying is carried out on the primary of the transformer supplying the power to the rectifiers.

The rest of the circuit is quite straightforward, the H.F. chokes being indicated by L_1 , L_2 , and L_3 respectively. A plain 100ft. aerial has been found to give the best results with this type of transmitter. The valve employed is of the ullard Type S.W.3L, capable of a continuous anode dissipation of 300 watts. To ensure stability a heavy filament is used, the filament current being 14.5 amps. at 13.15 volts. The current is supplied by a "floating" battery.

Construction of the Condensers.

From Fig. 1 it is seen that both C_1 and C_2 have one plate in common with one end of the tuning inductance. These two plates can, therefore, be combined to form one plate; a second plate is placed on one side of this plate to give C_1 , and a third plate placed on the other side gives C_2 . The illustration shown in Fig. 2 indicates how this has been carried out. The two plates are moved relative to the common plate by means of a combination of bevel and Geneva gearing, the motion being controlled by means of knobs shown on the panel view in the title illustration. The bevel gears are very carefully cut so that there is practically no back lash, and the use of Geneva gearing ensures a

fine motion. This gearing mechanism is stepped each time a complete revolution is made, and gives a visible indication of the number of revolutions made. A scale associated with the regulating knob assists in giving an exact indication of the position of the plates.

To avoid the losses which may be encountered at these high frequencies, the plates are supported by a box-like framework which is made up of glass rods fitted into castings. The whole framework is mounted on four insulators and is secured to the front panel by means of bolts. To avoid edge and interaction effects, the central plate is made larger than each of the other two. The plates and the castings are made of non-corrosive aluminium alloy, a material which has been found to stand up very well to sea air. The condenser unit is thus made both electrically and physically robust.

The maximum distance between the plates is substan-

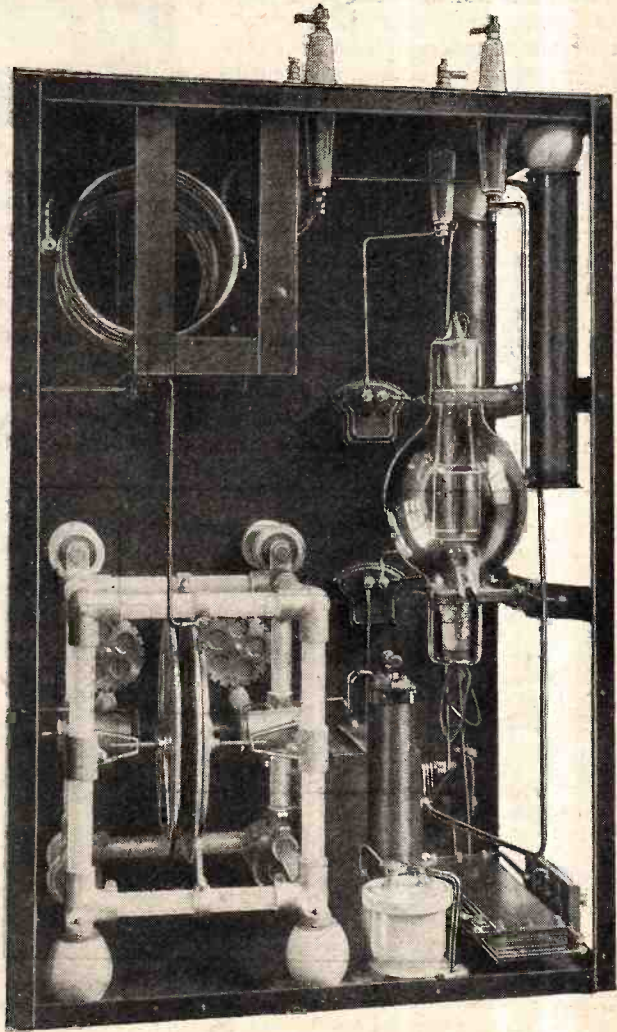

Fig. 4.—The complete transmitter layout.

tial, and the minimum capacity is very low. The values of capacity obtained are as follows: C_1 varies from 20 to 200 cms.; and C_2 from 12 to 120 cms.

Short Wave Ships Transmitter.—
General Layout.

Fig. 4 shows the layout of the transmitter. The tuning inductance and the aerial coupling coil are carried on a teak cradle which is secured to the top

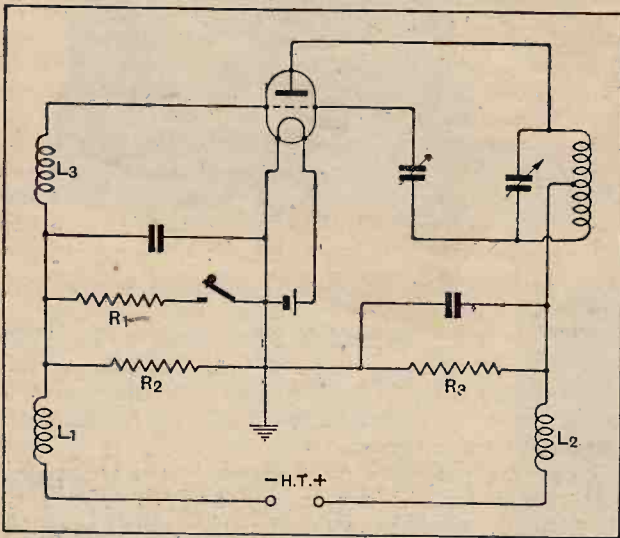

Fig. 5.—Method of keying when a machine is employed to supply the H.T. The resistances R_1 , R_2 and R_3 have values of 500, 30,000 and 300,000 ohms respectively. The bias is such that no plate current flows when the key is up.

panel by means of screws. The tuning coil shown in the illustration consists of eight turns of dull-nickelled copper tubing of $\frac{9}{32}$ in. external diameter, and it can be used for wavelengths down to 60 metres. For the

shorter waves tuning coils of four and three turns, respectively, are used. The coil changing is easily effected as each coil is fixed to the wooden platform by means of two bolts and thumb screws. The tuning coil is linked to the aerial by means of a coupling coil which consists of two turns of tubing. This coil is mounted on a spindle of composition insulating material and its position relative to that of the tuning coil is controlled by a knob mounted on the front panel.

The valve is held in position by means of two clamps which are mounted on metal brackets, which, in turn, are riveted to the main frame.

From the title illustration it is seen that the front panel carries the controls for the condensers, a knob to control the coupling between the aerial and the oscillatory circuit, a filament rheostat, a filament voltmeter, and a milliammeter to measure the plate current. The sides and back of the transmitter are made up of panels of heavy brass wire gauze. The panel adjacent to the tuning inductance is fitted with a door so as to facilitate removal of this coil.

The transmitter is exceptionally compact, its dimensions being 3ft. 5in. by 2ft. by 1ft. 6in. The method employed to key the transmitter depends on whether the H.T. for the valve is supplied from rectifiers or from a machine. In the case of the former keying is carried out on the primary of the transformer supplying the power to the rectifiers as shown in Fig. 3. When a machine is employed to supply the H.T., the keying is carried out as indicated in Fig. 5. The writer wishes to acknowledge his indebtedness to Messrs. Siemens Bros. for giving permission to publish these descriptive details.

THE BALSA WOOD DIAPHRAGM LOUD SPEAKER.

Results of *The Wireless World* Comparative Tests.

THIS new principle in the construction of diaphragms for moving-coil loud speakers was described by R. W. Paul and B. S. Cohen in a recent issue of this journal (April 9th, 1930), and has since been the subject of much discussion and not a little controversy. In order to give our readers a first-hand opinion of the performance of this loud speaker in its present stage of development, arrangements were made, through the courtesy of Mr. R. W. Paul, to receive one of these instruments for an extended comparative test in *The Wireless World* Laboratory.

The loud speaker tested had the following electrical constants:—

DIAPHRAGM	Diameter	11.4in.
	Mass	31 grams.
MOVING COIL	Turns	70
	Inductance	600 microhenrys.
	D.C. Resistance	15 ohms.
OUTPUT TRANSFORMER	Ratio	10 : 1.
FIELD MAGNET	Flux	180,000 lines in $\frac{1}{4}$ in. gap.
BAFFLE	Octagonal	33in. across flats.

As might be expected from the published frequency characteristics, the loud speaker is at its best when reproducing frequencies in the middle and upper, i.e., from 750 cycles upwards, and by comparison the band from 750 cycles downwards is deficient. In the particular instrument tested, however, frequencies between 50 and 100 cycles appeared to be better reproduced than those between 100 and 500 cycles.

The effect of this particular form of characteristic is to favour certain types of transmission. For instance, speech is perfectly natural and free from the hollowness often imparted by moving-

coil loud speakers. The solo violin is also excellent, as is also the piano in the upper register, though some of the richness of the bass notes in the latter instrument when sustained on the pedal is missed. The full orchestra loses something in depth and body of tone by comparison with cone diaphragm moving coils, but effects rich in transients such as cymbals, triangle, etc., are extraordinarily true to the original.

Some clue to the reason for the comparatively low acoustic efficiency in the lower register was obtained by visual observation of the diaphragm. There can be no doubt that the moving coil is developing the requisite amplitude at low frequencies; movements up to $\frac{1}{4}$ in. or $\frac{3}{8}$ in. are of common occurrence. But it is equally apparent that the diaphragm is not acting as a perfect piston at low frequencies, as it is intended to do. Even in the neighbourhood of 250 cycles differences in amplitude at different points on the circumference of the disc are easily detected by the eye. Now the reproduction of high frequencies is dependent upon the breaking up of the piston into different modes of vibration. The trouble would appear to be that this process is carried too far into the bass, and we understand that this is being investigated with the aid of Chladin dust figures, with a view to a possible revision of the arrangement of the stiffening ribs.

If this difficulty can be overcome without disturbing the present almost ideal response in the upper register, the result should have a far-reaching influence on the design of moving-coil loud speakers. In any case, the designers are to be congratulated for opening up an alternative channel of research to the cone diaphragm, which seems to have monopolised the attention of acoustic research workers for the past few years.

Kit Constructors' Notes

LOTUS ALL MAINS ADAPTOR



Converting the Osram Music Magnet for A.C. Mains Operation.

A HIGHLY specialised receiver like the Osram Music Magnet is far less susceptible to successful modification or alteration than is a set of more conventional design; an attempt to introduce anything approaching a radical change involves the risk, perhaps, of impairing the functioning of the ganged tuning system, to say nothing of upsetting the accuracy of the wavelength calibration, which is another of the outstanding features of this popular kit set. Indeed, *The Wireless World* Information Department often finds it expedient to decline to offer advice on alterations except with regard to details that have been checked experimentally, or which are obviously "safe."

In particular, there is always some hesitation in suggesting means whereby the receiver can be modified for mains operation; this is partly because a tuned-anode coupling is employed for the H.F. stage. There is, perhaps, rather a tendency unduly to exaggerate the difficulties consequent on this method of intervalve linkage, but whatever these difficulties may be they

seem to have been successfully overcome in the Lotus All-Power Unit, which is specifically designed for supplying L.T., H.T. and grid-bias potentials to the Music Magnet. The unit operates on A.C. supplies between 200 and 240 volts, 40 to 100 cycles. It can readily be connected to the set after a few minor wiring alterations have been made.

The principal piece of apparatus is a completely self-contained power unit mounted in a substantial metal case and fitted with an on-off switch and pilot lamp to show when it is working. Three valve adaptors, ready wired with twisted flex, and a pair of extra long distance-pieces for remounting the H.F. valve-holder, are included, together with a multiple battery cable with properly spaced tags for easy interconnection between set and power unit. These tags are so arranged that they fall more or less automatically on to their right terminals, but, as a check, the various leads are coloured so that connections may be verified with the help of a key diagram provided.

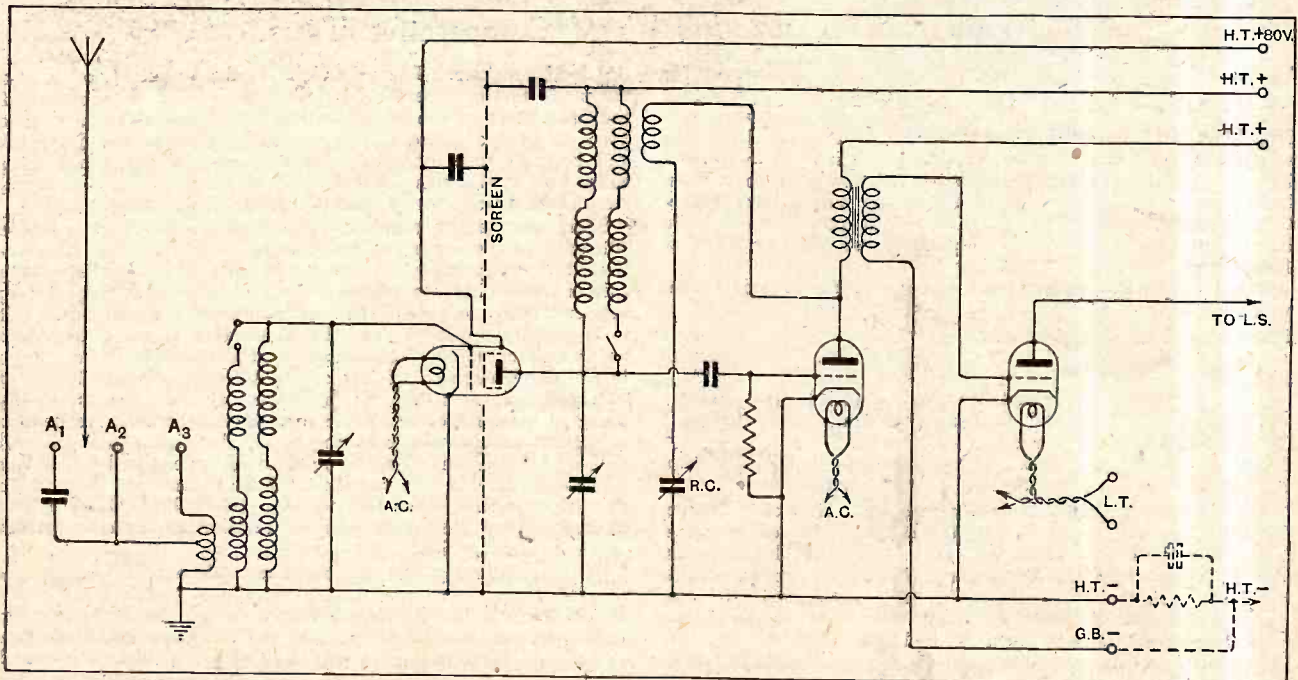

Circuit diagram of the receiver after modification. The bias resistance, shown in dotted lines, is included in the power unit.

Kit Constructors' Notes.—

The L.T. supply problem is solved—probably in the best possible way—by arranging to replace the existing valves by those of the indirectly heated type and to supply their heaters from an extra winding on the power transformer. The valves, incidentally, must be of the four-pin pattern, in which the cathode connection is led out through a side terminal; this point should be made quite clear when they are ordered, as standard specimens of the five-pin variety cannot be used with the adaptors as supplied with the kit. Starting from the input end of the receiver, the valves specified are Osram M.S.4, M.H.4, and M.H.L.4. With the help of the adaptors already mentioned, contact is made between the grid and anode pins of the new valves and the corresponding sockets of the original holders, while low-tension current at 4 volts is fed directly to the adaptor heater sockets through the flex leads. The cathode terminals are joined externally by short lengths of wire to the existing L.T. negative sockets of each valve holder.

When fitting the new distance-pieces for the H.F. valve holder it may be necessary to replace one or two of the existing wires with longer connections—this depends on whether the originals were cut accurately to length, or whether a certain amount of play was allowed.

Finally, it is necessary to change over the low-potential end of the detector grid leak, which must be joined to the cathode terminal on the valve-holder; this can be managed with the help of the grid-leak clips as supplied with the original set, but, to avoid all possibility of introducing a "short" across the grid condenser, it is not a bad plan to fit a separate holder for the resistance. In any case, the alterations are easy, and are clearly described in the pamphlet supplied with the apparatus; for the assistance of those who have not kept the original wiring plan of the Music Magnet it may be pointed out that the wire No. 12 (which has to be removed) is that normally connected between the +L.T. terminal of the L.F. transformer and the rear terminal of the tuned-anode coil.

Separate Anode Feeds.

It will be seen from the circuit diagram of the modified receiver that arrangements are made to feed each valve anode separately with an appropriate voltage from the eliminator; this is contrived without adding any complications by making use of the normal loud-speaker terminals for H.T. feed and by transferring the loud speaker itself to terminals on the power unit. The loud speaker is directly in series with the anode.

The grids of the first two valves are worked at zero potential, but "free" negative bias is provided for the output stage by the simple expedient of interposing a resistance of a few hundred ohms (which is mounted in the power unit) in the common negative lead. To prevent inter-stage coupling, the resistance is shunted by a large condenser.

The high-tension eliminator, which is intended to be used with an Osram U.5 rectifier valve, gives a more than adequate output voltage, amounting to about 175 volts on normal load. Series resistances, with the necessary by-pass condensers, are interposed in the feed leads for the detector and H.F. valve anodes, while a fixed potentiometer is used in the supply circuit for the screening grid of the H.F. valve. Full voltage is supplied to the output-valve anode.

Smoothing seems to be entirely adequate, and the converted set could be used even for headphone reception without any annoyance from hum; this applies particularly to the medium broadcast waveband, and, except on the rare occasions when one is blessed with an entirely silent background, without induction noises

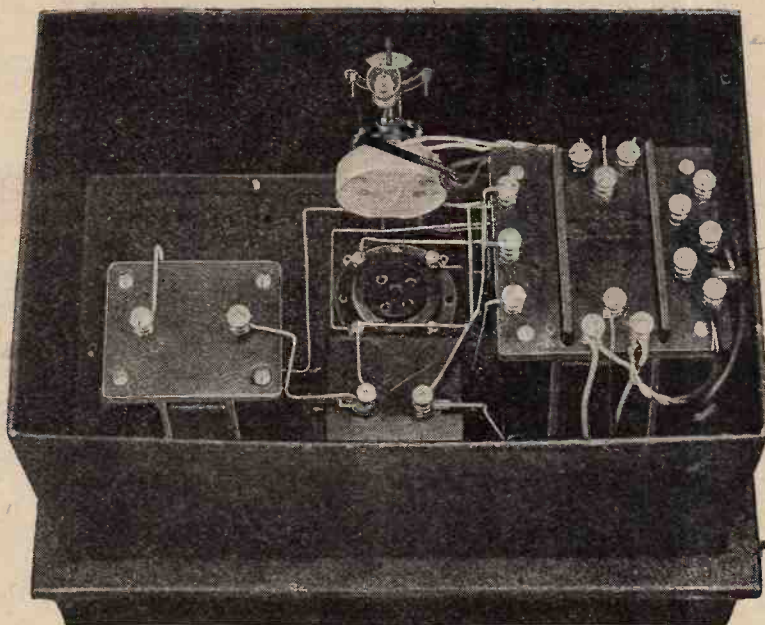

Interior of the power unit, with lid removed.

or atmospherics, it might easily be imagined that battery feed is being used.

The M.H.L.4 output valve recommended has a maximum power output in the order of 180 milliwatts; this may be considered as rather on the low side, but there seems to be no reason why an M.L.4 valve, which provides considerably more undistorted volume, should not be substituted if desired, as the eliminator is well regulated and maintains its voltage well under a heavier load than that imposed by the smaller valve. The free grid bias arrangement is more or less self-regulating.

Total consumption from the mains amounts to some 30 watts—no more than that of a small lamp—so it will be seen that a very real economy in upkeep cost is effected by the conversion. The ready-made power unit, complete with incidental apparatus, but without valves, costs £7 7s.; it may be obtained on the hire-purchase system for a deposit of 14s. 6d. and eleven subsequent monthly payments of the same amount. Valves are extra, and cost, with the rectifier, £3 15s. The manufacturers are Messrs. Garnett, Whiteley and Co., Ltd., Lotus Works, Mill Lane, Liverpool.

WIRELESS THEORY

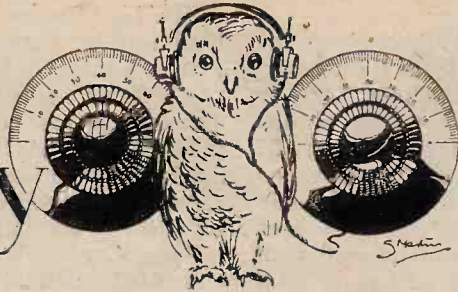

SIMPLIFIED

By S. O. PEARSON,
B.Sc., A.M.I.E.E.

Part XXXIV.—High-Frequency Losses in Condensers and Dielectrics.

(Continued from page 656 of previous issue).

IN a high-frequency tuned circuit the greater part of the energy loss usually occurs in the copper wire comprising the tuning coil; that is to say, the "copper losses" are usually greater than the whole of the losses due to other causes. Next in order of magnitude are the losses which occur in the insulating materials or dielectrics associated with the circuit, these being known as dielectric losses.

Considering a tuned circuit as a whole, the two main components are the coil and the tuning condenser, and the quality of each depends to a very large measure at high frequencies on the nature of the insulating material separating conductors between which exist high-frequency potential differences. Any two conductors separated by an insulator represent a condenser, and, when a potential difference exists between them, lines of electrostatic force are set up in the dielectric. From this it will be evident that dielectric losses can occur only in places where electrostatic capacity exists.

Losses in Condensers.

In the first place, then, we shall consider the losses which occur in the tuning condenser itself. Although a tuning condenser usually depends upon air as the main dielectric between the plates, the two sets of plates are held in their relative positions by some solid insulating material such as ebonite, and it is in this solid dielectric that practically the whole of the losses occur. Air and other gases are very nearly perfect insulators (unless ionised by excessive voltage between the plates) and the losses in such media are quite negligible.

The power going to waste in solid dielectrics may be divided into two classes, namely (a) that due to actual current leakage between the plates, through the insulation or over its surfaces, and (b) that due to the effect of the alternating electrostatic field which is present in the dielectric when an alternating potential difference is applied to the condenser.

Of these the former is of a comparatively simple nature as it virtually comprises a very high-resistance conducting path between the plates of the condenser, allowing a small amount of current to

"leak" from one set of plates to the other inside the condenser itself. Even a so-called insulator allows a certain amount of current to pass through it, but with good insulators, such as high-grade ebonite and mica, the amount of leakage occurring actually through the material is negligibly small and cannot even be detected by ordinary methods. With certain kinds of paper dielectric in fixed condensers and poor-quality moulded composition in variable condensers the leakage may be sufficiently large to result in serious power losses.

But even though the insulating material itself may be very nearly perfect as regards insulation resistance a leakage of current often occurs over its surface due to moisture or deposit from the atmosphere; and sometimes, in variable air condensers, dust may collect between the plates and bridge across from one set to the other, also resulting in leakage of current.

Losses due to these causes are more or less independent of frequency and occur even when a steady D.C. voltage is applied between the plates. A condenser with such losses may therefore be looked upon as a perfect condenser without losses shunted by a non-inductive high resistance as shown at (a) in Fig. 1, where C is the capacity of the condenser in farads and r is the parallel resistance equivalent to the insulation resistance in ohms of the actual leaky condenser.

The Equivalent Series Resistance of a Condenser.

When an alternating potential difference whose R.M.S. value is E volts is applied between the two sets of plates of a condenser the current passed is $I = \omega CE$ amps., where $\omega = 2\pi \times$ frequency; and in a perfect condenser the average power taken is zero because the current and voltage are exactly 90° out of phase. When the condenser possesses a "leak" of resistance r ohms, the leakage current is $\frac{E}{r}$ amperes and the average power

taken is therefore $E \times \frac{E}{r} = \frac{E^2}{r}$ watts. Now

it is usually more convenient to express the losses which occur in the condenser in terms of the equivalent series resistance. This is the value of resistance R which, connected in series with a per-

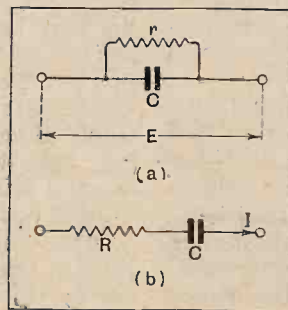

Fig. 1.—A condenser of capacity C farads shunted by a high resistance r ohms in an A.C. circuit is approximately equivalent to a condenser of the same capacity in series with a resistance R ohms where $R = \frac{1}{\omega^2 C^2 r}$ and $\omega = 2\pi \times$ frequency.

Wireless Theory Simplified—

fect condenser would account for the same power loss. The capacity value of the imaginary perfect condenser which, in conjunction with the equivalent series resistance R , gives a circuit of the same impedance and power factor as the actual condenser, will be very nearly equal to the capacity of the latter provided the leakage resistance is high compared with the reactance of the condenser, so that the angle of lead of the current is practically 90° . The following argument is based on this assumption, the capacity C being taken as the same in both the shunt and series arrangements. The equivalent series circuit is shown at (b) in Fig. 1.

The power lost in the resistance R is $P=I^2R$ watts, and equating this to the power absorbed in Fig. 1(a) we

have $I^2R = \frac{E^2}{r}$ watts, where $I = \omega CE$ amps., so that $(\omega CE)^2 R = \frac{E^2}{r}$, from which $R = \frac{I}{\omega^2 C^2 r}$ ohms (1)

where $\omega = 2\pi f$.

Thus a condenser of capacity C farads shunted by a high resistance r ohms can always be considered as a perfect condenser of the same capacity with a resistance

of $\frac{I}{\omega^2 C^2 r}$ in series with it.

But $\frac{I}{\omega C}$ is the reactance

X_c of the condenser, so that the equivalent series resistance is equal to the square of the reactance

divided by the shunt resistance, namely, $R = \frac{X_c^2}{r}$ ohms.

From equation (1) above it is quite clear that the leakage resistance r becomes of less importance as the frequency is raised and as the capacity is increased. It is nearly always negligible at radio frequencies, the equivalent series resistance being inversely proportional to the square of the frequency.

Dielectric Absorption.

On the other hand, the second source of power loss (b) mentioned above is by no means negligible at high frequencies, arising as it does from the action of the alternating electrostatic field on the dielectric. The nature of the losses due to this effect is not quite so well understood. When a steady potential difference is suddenly applied to the terminals of a condenser there is a sudden rush of charging current which lasts for a very small fraction of a second only. During this very short interval the condenser is fully charged—any condenser is fully charged when once the potential difference between the plates has reached a steady value. But it is found that with most solid dielectrics, even after the condenser has been fully charged and the voltage between the plates has become steady, that a small current continues to flow for some time *without*

producing any change in the voltage between the plates. This is an extra current quite apart from the normal charging current; it is greatest immediately after the condenser is charged and gradually dies away to zero, being apparently caused by some change taking place within the dielectric.

This property of the dielectric of a condenser by virtue of which a quantity of electricity is absorbed after the normal charging current has ceased is referred to as "dielectric absorption."

When the charged condenser is discharged by short-circuiting its terminals the normal discharge current lasts for a small fraction of a second, but for a considerable time afterwards a further small current continues to flow in spite of the fact that the voltage between the plates has been reduced to zero. In other words, the extra quantity of electricity which was absorbed after the condenser was charged is given out again after it has been discharged. But as the absorption current

was put in under pressure and given back without any voltage between the plates it follows that a certain amount of energy has been given to the condenser and not returned; it must therefore have been converted into heat.

It seems reasonable to suppose, then, that when an alternating voltage is applied to the terminals of the condenser there will be, besides the normal current ωCE amps. represented by the repeated charging and discharging

of the condenser, a further alternating current due to the absorption effect. Now, the normal charging current is just a quarter of a cycle out of step with respect to the applied voltage, and therefore represents zero average power—the energy represented by this current during a quarter cycle when the condenser is being charged up is stored in the electric field and the whole of it is given back during the next quarter of a cycle when the condenser is discharged again. On the other hand, the current arising from the absorption effect has a component in phase with the applied voltage, and therefore represents a certain amount of energy per cycle which is not given back to the circuit, being converted into heat in the dielectric.

Experiment tends to prove that the major part of the power absorbed by a condenser in an A.C. circuit is due to the absorption effect. It depends on the dielectric used and on the frequency.

The high-frequency losses in the solid dielectric of a condenser are proportional to the volume, and therefore, in the construction of a variable air condenser, the dielectric used for supporting the set of fixed plates should be of small bulk; but at the same time its thickness in the direction of the lines of force must be sufficient to keep the intensity of the field in it to a reasonably low figure, because the loss in watts per

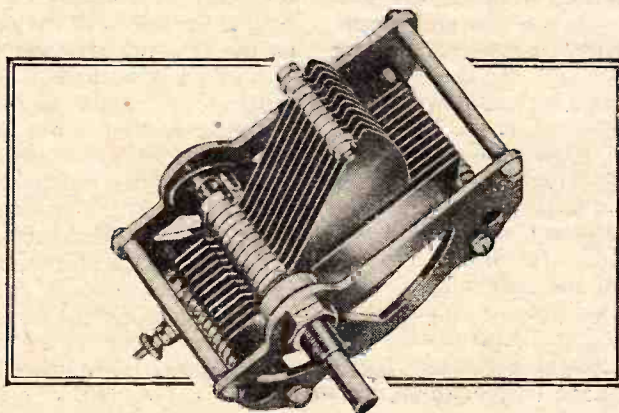

Fig. 2.—A typical low-loss air-dielectric variable condenser.

Wireless Theory Simplified.—

cubic centimetre at any one frequency is proportional to the square of the field intensity, which is in turn proportional to the volts per centimetre. The greatest dimension of each support should therefore be in the direction of the lines of force.

The Power Factor of a Condenser.

No matter what the causes of power losses in a condenser may be, the fact remains that, of the energy put into the condenser when it is charged, only part of it is returned to the circuit on discharge, and thus a certain amount of energy is lost every half cycle, and the amount of energy lost per second is equal to the power absorbed by the condenser. A source of loss not mentioned so far is the high-frequency resistance of the leads, terminals and plates.

The excellence or otherwise of a coil or a condenser for use in a tuned circuit can be gauged from its *power factor* over the normal range of operating frequencies—the lower the power factor the better the component. It has already been shown that for a *series* circuit the

power factor is $\frac{R}{Z}$, where R is the resistance and Z

the impedance of the circuit. The equivalent series resistance of an imperfect condenser can always be expressed to a fair degree of approximation when the condenser is used in high-frequency circuits because even with an indifferent condenser the energy lost per half cycle is a small fraction of the energy stored and given up again during that time.

Suppose that the power lost due to all causes in a condenser of C farads is P watts at a frequency of f cycles per second. Then if I is the current in amperes flowing in the condenser circuit, and R is the equivalent series resistance in ohms, we have $P = I^2 R$ watts, or

$$R = \frac{P}{I^2} \text{ ohms.}$$

Now, if E is the voltage applied to the condenser, and if R is small compared to the reactance X_c , the current is given very approximately by $I = E/X_c$

amperes, from which $\frac{E}{I} = X_c$ ohms very nearly. Strictly speaking, the ratio $\frac{E}{I}$ is equal to the actual impedance

of the equivalent series circuit, and therefore the power factor of the imperfect condenser is very nearly equal to R/X_c , where $X_c = 1/2\pi fC$ ohms. Hence we have

$$\text{Power Factor} = 2\pi fC \times R,$$

where R is the equivalent series resistance of the condenser. From this it might at first appear as though the power factor were proportional to the frequency, but it must be remembered that the equivalent series resistance R also depends on the frequency. For instance, we have already seen that for losses arising from ordinary leakage the equivalent series resistance is inversely proportional to the square of the frequency, the losses being constant. But absorption losses increase rapidly with frequency, and the power factor may either increase or decrease as the frequency is raised.

Very often the power factor of a condenser remains fairly constant over a very wide range of frequencies; it is usually independent of the voltage, provided this is not sufficiently high to cause an excessive temperature rise. Just as in the case of an ordinary resistance, the power loss is proportional to the square of the voltage and the temperature rise is proportional to the power loss. In the case of receiving condensers, however, it is hardly necessary to guard against temperature rise!

The Power Factor of a Dielectric.

In a variable condenser, assuming that the losses occur wholly in the solid insulation, the power loss at any one voltage and frequency is independent of the condenser setting, and therefore the power factor of such a condenser is inversely proportional to the capacity reading. But when it is used as a tuning condenser in conjunction with a coil the frequency is inversely proportional to the square root of the capacity (neglecting stray capacities such as self-capacity of the coil), and so the losses in the condenser will actually increase as the capacity value is lowered.

A fixed condenser with all solid dielectric has the same power factor no matter what quantity of the dielectric is used. For by doubling the thickness of the dielectric between the plates we are at the same time halving the capacity and halving the intensity of the field within the dielectric. The power loss per cubic centimetre is therefore *cut down to one quarter*, but since the volume of insulating material has been doubled the actual power loss is now half as much as it was before, assuming the same voltage between the plates. Now, the power factor of any circuit is the ratio of the power P consumed to the product of volts and

amps., so that the power factor is given by $\frac{P}{EI}$. Since

the capacity has been halved the current I is halved as well, and so, with the double thickness of insulation,

the power factor becomes $\frac{\frac{1}{2}P}{\frac{1}{2}EI} = \frac{P}{EI}$, which is the

same as before. It follows, then, that the power factor of an insulating material is equal to the power factor of a condenser made with that material as the sole dielectric, and vice versa.

In the following list are given some representative figures for the power factors of various solid insulators at a frequency of 500 kilocycles per second:—

Pyrex glass, 0.004.

Plate glass, 0.007.

Good ebonite, 0.01.

Mica laminæ, 0.015 to 0.02.

Bakelite fibre, 0.035 to 0.05.

Air, of course, has a negligibly small power factor, and a variable condenser in which any one of the above solids is used for supporting the fixed plates should have a power factor considerably less than the corresponding figure for the material used, provided the surfaces are free from deposit or moisture and that there is no dust between the plates.

(To be continued.)

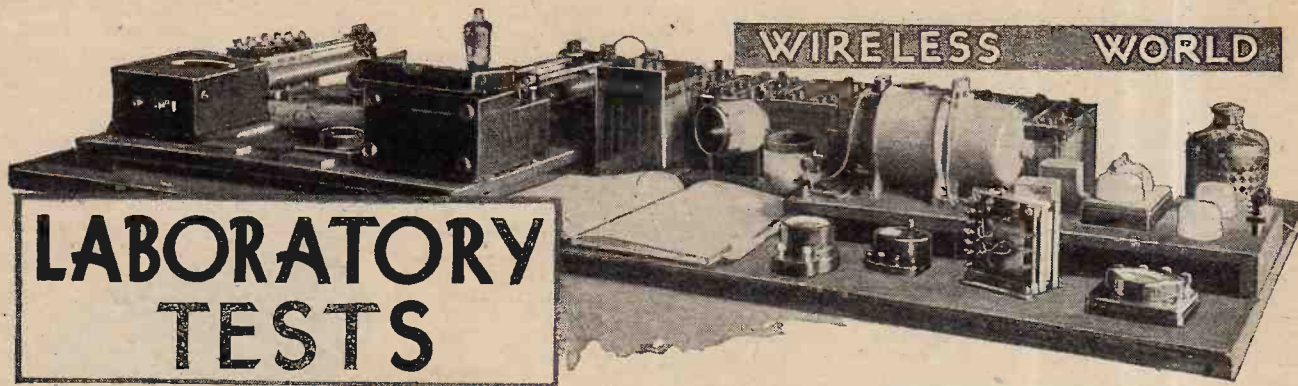

A Review of Manufacturers' Recent Products.

"YARG" REMOTE CONTROL RELAY.

In many homes the wireless receiver is regarded as a means of providing entertainment, and as a consequence the tuning controls attract scant attention. In these cases it could conveniently be located in an out-of-the-way part of the house, which can be wired with extension leads to sundry loud speaker points. The question of control naturally enters into these schemes, and to meet such needs the "Yarg" relay has been developed. In all there are four standard models; the one illustrated being the type "A," which has a single make-and-break contact for switching on or off the L.T. only. The price of this is 10s. 6d.

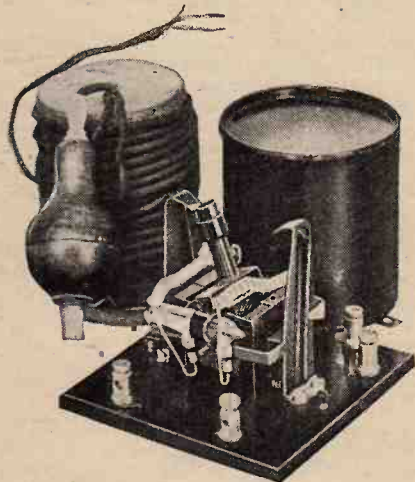

"Yarg" remote control relay, in which contact is made between mercury and mercury enclosed in a special sealed tube.

The type "B," which costs 17s. 6d., will control two circuits, such as the filament supply and an H.T. eliminator. Type "C" is a three-circuit relay which does the same work as "B," but in addition brings an L.T. trickle charger in operation when the set is idle. This model costs 22s. 6d. Type "D" has been designed especially to meet the needs of those using a D.C. H.T. eliminator, and in

addition to switching the filament supply completely isolates the mains from the set when in the "off" position. The price is 25s.

The various circuits are open or closed by contact between mercury and mercury which is carried in a special glass tube sealed and filled with an inert gas to prevent oxidation of the mercury. A perfect contact must ensue, and, moreover, the contact resistance will be negligible.

The current energising the relay is drawn from the filament battery, but there is no continuous drain, as current flows only for the moment or so that the press button contact is closed to actuate the relay. The rocking armature, to which is fixed the mercury tube, is maintained in position by means of a counterweight.

A practical test was made with a model "A" relay, which was found to require a minimum current of 1.2 amps to operate it. This only flows momentarily, of course. The D.C. resistance of the relay winding was found to be 0.69 ohm. It is possible, therefore, to calculate the amount of resistance permissible in the extension leads to the various control points. The makers state that with a 2-volt cell a 20-yard extension of No. 20 S.W.G. twin bell-wire is permissible. If the control point is 30 yards distant, No. 18 S.W.G. bell-wire must be used.

Full details regarding the type of wire for various distances and battery voltages are given in the instructional folder, and a blueprint showing the connections to the relay accompanies each unit. The makers are "Yarg," 1, Eccles Old Road, Pendleton, Manchester.

o o o o

SIX-SIXTY VALVE ADAPTOR.

In many cases a battery-operated set can be converted into an A.C. mains receiver by merely fitting the indirectly heated type of valves and installing an eliminator for H.T. and grid bias. The alteration involves replacing the valve holders by others provided with five sockets and rearranging the connections accordingly.

Even this apparently simple alteration possesses many pitfalls for the beginner, and with a view to simplifying the operation in these cases the Six-Sixty Radio Co., Ltd., Six-Sixty House, 17-

18, Rathbone Place, Oxford Street, London, W.1, have evolved an adaptor which greatly simplifies this conversion. This particular model is styled the 5-4-pin adaptor, and consists of a moulded plug carrying 4 pins on the under side, 5 sockets on the top face, and 2 small terminals on the side. The grid and anode pins contact direct with the similarly placed sockets on the top, but the two filament pins are joined internally and taken to the centre socket on the top face.

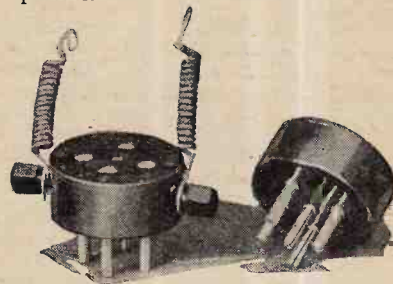

Six-Sixty valve adaptors. The one with side terminals converts 4-pin valve holders for use with 5-pin A.C. valves.

The two sockets, which correspond with the heater pins on the A.C. valve, are joined each to a small terminal on the side of the adaptor. To change over the filament connections, the L.T. accumulator must be removed and an adaptor fitted into each valve holder. The wires anchored to the small terminals can then be joined to the 4-volt winding on the mains transformers. These adaptors cost 2s. each.

To reverse the process and convert the 5-pin type valve holders for use with the 4-pin battery-fed valves, another adaptor, designated the 4-5-pin type, can be used. This has five base pins and four sockets on the upper side. The four sockets corresponding to grid, anode and filament are connected direct to similarly placed pins underneath, while the centre pin is joined to one of the filament sockets. The L.T. accumulator can thus be connected to the leads that hitherto went to the 4-volt winding on the transformer. The polarity of the cells must be arranged so that the

negative terminal is attached to that filament lead to which is joined the centre pins on the valve-holder adaptor. These adaptors cost 1s. 6d. each.

o o o o

FIVE PER CENT. DISTORTION SCALE.

Before selecting a valve for any specific purpose it would be distinctly advantageous if some figure of merit could be calculated so that the comparative performance of several makes could be examined. For H.F. transformer coupling where the correct primary winding is arranged to suit the A.C. resistance of the preceding valve

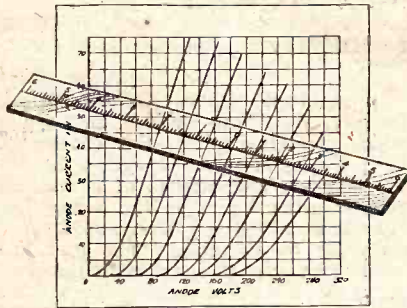

Five per cent. distortion scale for measuring A.C. power output of valves.

the figure of merit is the amplification factor of the valve divided by the square root of its A.C. resistance. In output valves it is usual to calculate the milliwatts undistorted output per volt grid swing, assuming that a maximum of 5 per cent. second harmonic is unobjectionable and that the valve is working into a load that is approximately twice its A.C. resistance. To facilitate the graphical method of determining A.C. output Messrs. H. K. Lewis and Co., Ltd., 136, Gower Street, London, W.C.1, are marketing a celluloid scale having a zero at approximately the centre with the scale divisions on the right 9/11th those on the left. If the zero is placed on the operating point (optimum grid bias, working anode volts, etc.) of the anode current/anode volts curves and the scale swung round to coincide with the load line, the zero grid volts curve should give the same reading on the scale as that for the grid volts curve representing twice the bias volts. Should this condition be satisfied, then the A.C. output with a maximum of 5 per cent. second harmonic distortion is a quarter the area of a right-angled triangle the hypotenuse of which is the load line. With some valves it may be necessary to deviate from the maker's bias before the maximum output is got; with others the load may require changing to a greater value to avoid overstepping the maximum D.C. watts dissipation limit. For further notes on the use of this extremely useful accessory reference should be made to an article entitled "Valve Data" in December 4th, 1929, issue, and to the test report on the PX4 valve in this issue. The scale, which is engraved on the underside to avoid parallax effect, sells at 4s. 6d.

R.I. L.F. CHOKE. Type D.Y.11.
Designed for use in eliminator smoothing circuits and output filters, this choke will pass a maximum current of 140 milliamps, although its normal working range is given as 0.100 milliamps only. The D.C. resistance of the winding is 260 ohms, which figure is sufficiently low to preclude any serious voltage drop across the choke even when carrying relatively large currents. Some measurements were made with a sample choke with various values of D.C. flowing in the winding; the following inductance values being obtained:—

D.C. mA.	Inductance henrys.	D.C. mA.	Inductance henrys.
0	37.8	60	16
20	22.8	80	13.9
40	19	100	12.5

For a heavy duty choke of reasonable size and weight and costing 21s., these results may be regarded as highly satisfactory. A neat metal case, finished in crystalline black, totally encloses the choke, and, in addition to enhancing its

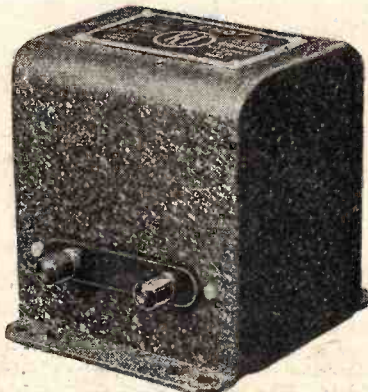

R.I. heavy duty L.F. choke to carry 140 mA. with an inductance rating of 14 to 28 henrys.

appearance, serves completely to shield the winding, thereby minimising the chance of unwanted magnetic coupling between it and other components in the set. The makers are Radio Instruments, Ltd., 12, Hyde Street, New Oxford Street, London, W.C.1.

o o o o

CLAROSTAT TANDEM VOLUME CONTROLS.

There has been introduced recently, by the Clarostat Manufacturing Co., Inc., of New York, a range of volume controls comprising wire-wound resistances and potentiometers suitable for practically every type of volume adjustment, so designed that two or more units can be mounted in tandem and operated by a single knob. These components are marketed in this country by Messrs. Claude Lyons, Ltd., 76, Oldhall Street, Liverpool. It is thus possible to provide simultaneous control of volume before and after the detector,

a method which approaches very closely to the ideal. As a further means of reducing the number of control knobs, the "on" and "off" switch can be incorporated in this tandem assembly. When the volume control just reaches the minimum position the switch is moved to the "off" position.

Each resistance unit is entirely separate, so far as electrical connection is concerned, and it is possible to assemble

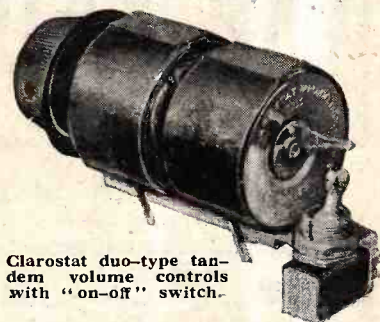

Clarostat duo-type tandem volume controls with "on-off" switch.

a high-resistance potentiometer, a filament resistance and a switch all in entirely separate circuits but controlled by one knob. Many other combinations can be had, and full particulars will be willingly supplied by the concessionaires.

o o o o

SAXONIA MERCURY SWITCHES.

The growing tendency of housing the receiving set away from the loud speaker has created a demand for remote control switches. Not only is a reliable magnetically operated switch required, but owing to the fact that many circuits may be mains connected, particular attention must be taken to ensure reliable contact and insulation. Probably the best form of contact is that afforded by a bead of mercury running in a sealed tube and arranged to bridge wires sealed into the sides. Such a contact is easy to operate, makes a positive connection, passes a heavy current, and gives a quick break. The insulation provided between the contacts is practically perfect, and switches of this type possess negligible capacity between their contacts, thus rendering them suitable for use in H.F. carrying circuits. An extensive range of inexpensive

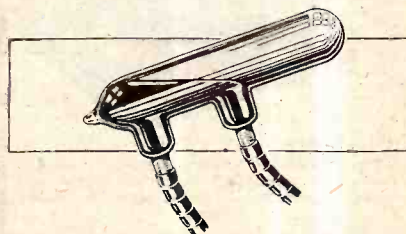

Single control Saxonía switch for use in remote control relay.

switches for use with remote control relays is available from the Saxonía Electrical Wire Co., Ltd., Roan Works, Greenwich, London, S.E.10. Movements for operating these switches are being produced by the Watmel Wireless Co., Ltd., Imperial Works, High Street, Edgware, Middlesex.

Mr. Whitley at Savoy Hill.

Lord Clarendon has bidden farewell to Savoy Hill, and while at the moment of writing no announcement has been made that Mr. Whitley has officially assumed the chairmanship, he has been in evidence at headquarters for the past ten days.

o o o o

Hope Springs Eternal.

It seems inevitable that whenever a change, great or small, is made in the administration of the B.B.C. the outside public must instantly build hopes on the possibility of some epoch-making transformation in the whole system of broadcasting.

Recently we had a demonstration of this when Mr. Roger Eckorsley handed to Mr. Cecil Graves some of the detail work in connection with programme building. It was immediately thought that this meant a revolution in programme production.

o o o o

An Inaccuracy.

We have now been told in regard to the much more important change of the chairmanship that Mr. Whitley is to carry out a thorough investigation on the conduct of the B.B.C. at the request of the Prime Minister, to whom he is to report.

o o o o

Mr. Whitley and the Staff.

This suggestion has been contradicted by Mr. Whitley himself. The feeling at Savoy Hill is that Mr. Whitley will be a conscientious chairman who will do his utmost to safeguard the interests of listeners, at the same time taking a practical interest in the welfare of the staff and his immediate subordinates.

o o o o

A "Whitley Council"?

It would not surprise me if a "Whitley Council" were set up to discuss the queer amphibian status of the B.B.C. staff, the members of which are neither Civil Servants nor plain Tom, Dick, and Harry. They have a provident fund, but its working principles do not appeal to the majority at Savoy Hill. There is a keen desire for a revision.

o o o o

Liberality of Outlook.

A hopeful member of the staff is expecting liberal treatment, both the Chairman and Vice-Chairman being strong representatives of that political persuasion.

o o o o

Money Questions at Falkirk.

Although, as stated in these columns a fortnight ago, the B.B.C. has practically decided on the choice of the Falkirk site for the Scottish Regional station, there are one or two questions which have to be thrashed out before an official announcement can be made.

If the B.B.C. found that the price asked for the land was excessive or was increased after negotiations had started they would have no hesitation in altering their plans.

o o o o

Independent Landowners.

Such a situation did arise more than once during the search for the London Regional site. Several favourable posi-

Broadcast
Brevities

By Our Special Correspondent.

tions were found in Bedfordshire, Buckinghamshire and Middlesex, but landowners showed such a vigorous spirit of independence that their zeal overshot the mark, hence Brookmans Park!

o o o o

A Cry from Cardiff.

The latest broadcasting pother has cropped up at Cardiff in consequence of the B.B.C.'s decision to transfer the dramatic producer, Mr. Arthur Blanch, to Belfast. Cardiff listeners see in this "yet another flaunting of Welsh rights and aspirations," assuming that Mr. Blanch will not be replaced and that Wales will in future draw its broadcast dramatic talent from London.

o o o o

Promotion.

Actually, I understand, a new dramatic director is already packing his trunk to proceed to Cardiff. This being so, few Welsh listeners will grudge Mr. Blanch the honour of promotion. His predecessor at Belfast has proceeded to London, the ultimate goal of all ambitious B.B.C. folk, so Mr. Blanch may consider himself a step nearer the Savoy Valhalla.

Sunday Morning Broadcast.

From York Minster a special service will be relayed to the whole country next Sunday morning, June 29th. This is the service known as St. Peter's service, June 29th being dedicated to that saint. The address will be given by the Archbishop of York, the Right Rev. William Temple.

o o o o

H.R.H. to Broadcast.

The Prince of Wales's speech at the National Union of Students dinner, which takes place at the Savoy Hotel on July 7th, will be heard from all transmitters radiating the National programme at 9.25 p.m.

o o o o

Broadcasting the R.A.F. Display.

Events which are to be relayed from the Royal Air Force Display in the National programme on Saturday next, June 28th, open with the flight over Hendon of R101. Next will come a demonstration of upside-down flying, parachute descents, aerobatics with coloured smoke, a parade of new and experimental types of machine, and an attack on a kite balloon. Squadron-Leader W. Helmore and Captain Derek McCulloch are the B.B.C. commentators.

o o o o

A Microphone at Bisley.

The shooting for the King's Cup at Bisley on July 19th is again to afford material for a running commentary to be given in the National programme.

o o o o

Approved!

How glad we all are that the Slaithwaite Urban District Council on June 12th officially approved the plans for the Northern Regional station at Pole Moor, the main building of which was already near completion. The B.B.C. could never have survived the disgrace of having to tear it all down.

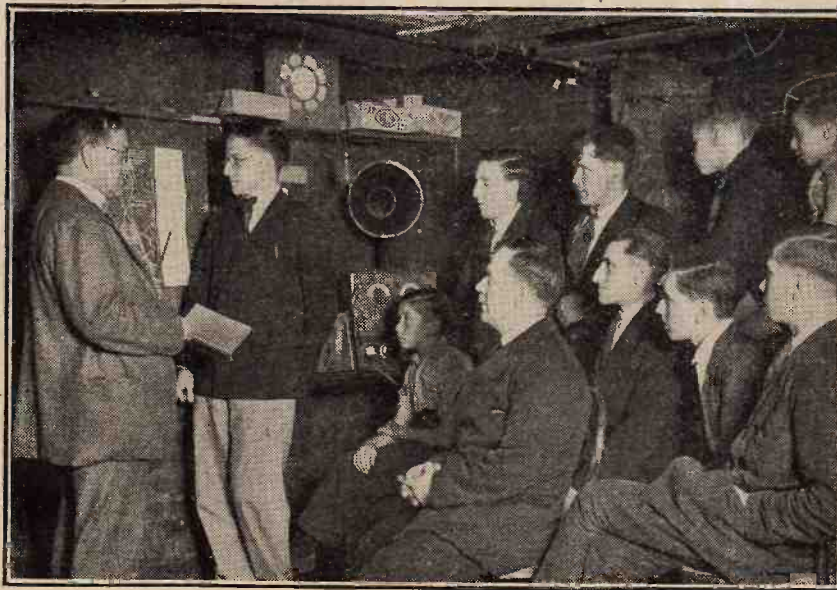

A CHURCH WIRELESS CLUB. Members of the St. Judé's (Bathnal Green) Wireless Club photographed at a meeting in the Vicarage cellar. Constructional talks are given by the Rev. J. Ough, M.A., seen on the left.



CORRESPONDENCE

The Editor does not hold himself responsible for the opinions of his correspondents.

Correspondence should be addressed to the Editor, "The Wireless World," Dorset House, Tudor Street, E.C.4, and must be accompanied by the writer's name and address:

EMPIRE BROADCASTING.

Sir,—Your Editorial in your issue of April 9th, 1930, just to hand is pleasant reading indeed, and all thanks are due to you for having persistently voiced a just cause—namely, our needs in regard to Empire broadcasting. The carefully selected words in which you refer to your "slight services" on our behalf extending over "three years" is your usual pose of modesty. We Colonials know full well that you have done a good deal indeed to champion our cause—always an uphill work—and we take this opportunity to express our extreme gratitude to you. We know that the real thanks will be given to you not by such as the writer, who is comfortably perched up in an office in a metropolis, but by the missionaries, planters, soldiers, and the poor bedridden Britishers in hospitals all over the Empire.

In the same issue of your journal I read that the B.B.C., in their reply to your Lahore correspondent, Mr. Booty, plainly say it is a matter of finance, and that the B.B.C. have no money to erect and finance an Empire station. They are quite right, and it would be cruel to fleece the B.B.C. any more. They, I think, have done enough even in erecting the present experimental station at Chelmsford, financially embarrassed as they are. It stands to reason that the money must come from somewhere else. In this connection may I humbly ask why the Treasury, with "folded arms" as it were, receives £856,000 of the licence moneys, as stated at page 392 of your issue above referred to? The whole broadcasting scheme is based on the furtherance of the interests of the British wireless trade; in fact, it owes its very inception to these interests, and the men who ran the original B.B. Company were men with these interests behind them.

It stands to reason that if an efficient Empire broadcast station is established from a part of the money that is going to the Treasury it will bring along in its trail the inevitable erection of local long-wave stations in each colony for the retransmission of the short-wave broadcast material, and as a result the home output of wireless goods will be stimulated. C. P. MARTINNS.
Singapore.

Sir,—Your correspondent, Mr. Arthur Hobday, considers that G5SW should be financed independently of the funds provided by British licence payers. He says that few British listeners hear G5SW; that may be so, but surely he does not ignore the fact that very many British licence payers "reach out" to foreign stations to which they contribute nothing. Your own excellent journal, Sir, is the best possible proof of the interest taken at home in foreign stations. If G5SW is to be financed by listeners outside Britain, then surely elementary justice and reciprocity will demand that British listeners shall contribute to the short-wave transmissions of PCJ, Zeesen, etc., and also that they refrain from tuning in to G5SW. At present it seems that the British licence payer is getting considerably more than he pays for, and Mr. Hobday's suggestion is to increase the disparity. GEORGE L. BOAG.

Aguilas, Spain.

BALSA WOOD AND OTHER DIAPHRAGMS.

Sir,—I agree with Mr D. E. L. Haynes, who contributes to the Correspondence columns of your issue of June 4th, that the ultimate test of any loud speaker must be subjective. I think, however, we must be in disagreement regarding the method of test.

The more prominent distortions occurring in any reproducing mechanism are: (a) coloration, (b) resonance and incorrect frequency response generally. Coloration, if strange, is usually most objectionable. The ear has, however, an enormous capacity for ignoring it when it has grown familiar—hence the

possibility of the gramophone as a musical instrument. Resonance and bad frequency response, on the other hand, grow on one, and, if the resonances are prominent, one's dissatisfaction increases to the destructive stage. A wise listener then reconstructs his speaker, or buys another, possibly to repeat the cycle at varying intervals.

I suggest that the quality of a speaker is measured by the rate of increase of one's satisfaction with it; for a good speaker this is positive, for a bad one it is negative. A loud speaker should be tested by living with it for a month. An effective subjective test cannot be carried out in half an hour. If one has only that time to spare, it is better not to listen to the speaker, but to look at its response curve. That will indicate whether it will make one shudder later. The eye is not so hopeless as the ear at deciding in a hurry.

A diaphragm speaker depends entirely upon resonances for its upper register. I have shown elsewhere that, in the case of an elastic material, the resonances produced in the upper part of the scale are very prominent. This state of affairs is useless acoustically; some sort of average balance may be obtained, but the output is concentrated round a number of definite frequencies. To secure tolerable reproduction the number of modes of vibration must be great and the resonances flat. McLachlan has shown how these conditions obtain in the paper diaphragm. This material will probably hold the field for some time to come. Undoubtedly paper has a characteristic coloration. With judicious treatment, however, this may be reduced to the point where the ear can learn to ignore it. Substitutes for paper must not be sought amongst the elastic materials, whose resonant frequencies are too sharp.

One final word. I am not sure whether I share Mr. Haynes's aversion to the "woolly thuds" of the bass. There are, of course, degrees and varieties of woolliness. But I think that a bass devoid of all woolliness is not a bass at all, but simply the harmonic ghost left after the fundamental has been strangled.

Bexley Heath, Kent.

A. G. WARREN.

BROADCASTING IN INDIA.

Sir,—Commenting on the failure of the Broadcasting Company in India in the April 9th issue of your much esteemed and popular journal (page 384), it is stated that the failure of the company is mainly due to the "pirate" nuisance, but I feel sure that correct information regarding this was not supplied to you. I have been a listener of the broadcasting stations for the last five years, much before the Indian Broadcasting Company came into existence. People in India had high hopes about the success of the company in the beginning, for there is not the slightest doubt that the transmissions from Bombay and Calcutta have been excellent and the listeners enjoyed the programmes immensely.

But, as is well known, the transmissions were and are being made on long waves only, which it is impossible to receive clearly during the greater part of the year, namely, hot and rainy season, on account of the intense tropical heat and other factors. I have seen quite a number of people getting disgusted with transmissions from Bombay and Calcutta during the hot and rainy season, on account of the crackling noises due to atmospherics. This is one of the reasons why the listeners in India have been pressing for the Empire broadcasting service from 5SW through your esteemed columns. The short-wave transmissions from this station are unaffected by the atmospheric condition. A suggestion for broadcasting on short waves from Bombay and Calcutta was consequently made, but it appears it is too late to mend matters. Thus it would be clear that the failure of the company was not due to "piracy" but mainly due to the reasons explained above.

Dharmasala.

D. N. VASUDERA, B.A., M.Sc.

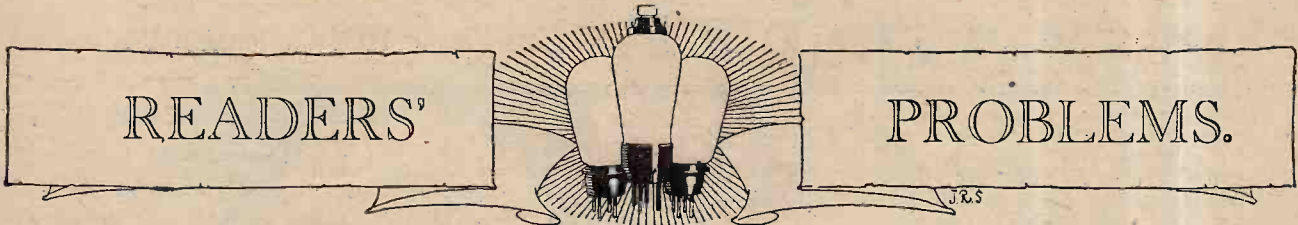

"The Wireless World" Supplies a Free Service of Technical Information.

The Service is subject to the rules of the Department, which are printed below; these must be strictly enforced, in the interest of readers themselves. A selection of queries of general interest is dealt with below, in some cases at greater length than would be possible in a letter.

Power Grid Detection with Battery Valves.

As it is possible for a power grid detector to work satisfactorily with 150 volts on the anode, would it not be permissible to use a battery valve (my set derives its L.T. current from an accumulator) instead of the indirectly heated A.C. valve, as recommended in your issue of May 7th? In the event of this being practicable, will you please suggest a suitable type of valve for use as a rectifier? C. F.

It should be remembered that when a manufacturer fixes the maximum anode voltage of his valves at 150, he assumes that those of the comparatively low impedance type, such as would be used for power grid detection, will normally be operated with a negative grid voltage. A power grid detector, working in the manner described in the article to which you refer, is operated with a zero grid; in consequence, anode wattage dissipation will be somewhat higher than that for which the valve was intended by its designers, and its life might be reduced.

As a result of enquiries addressed to the manufacturers, we think it safe to say that valves of the Mullard "D" class (P.M.2 D.X., P.M.6 D., etc.), and the Marconi or Osram "L" range, would be quite satisfactory, and, furthermore, could be depended upon to have a reasonable life. The same might apply to other valves, and we hope to publish some definite information on this subject in the near future.

o o o o

Free Grid Bias for the "Record III."

Will you please show me how to provide free grid bias for the indirectly heated output valve of my "Record III" receiver? Needless to say, it is proposed to retain battery bias for the H.F. and detector valves.

E. P. T.

We suggest the arrangement shown in Fig. 1. A separate transformer, or, at any rate, a separate L.T. winding, will be required for supplying the heater of the last valve.

From the fact that you wish to obtain free grid bias, it is assumed that in the output position you are using a valve consuming a fairly heavy anode current, and consequently requiring a fairly considerable bias voltage; if the valve is of the A.C./P.1 type, the bias resistance

(R in our diagram) will have a value in the order of 1,750 ohms. The associated by-pass condenser C may be of 2 mfd. capacity.

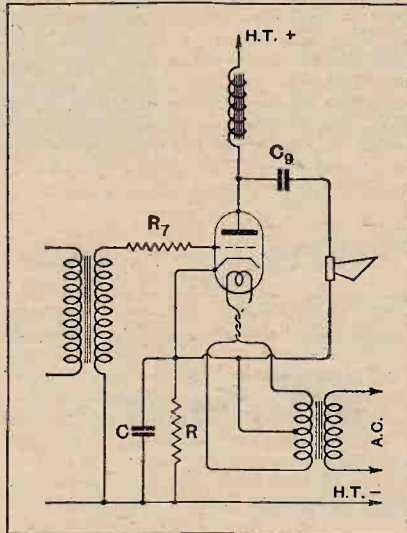

Fig. 1.—Output valve cathode-heater circuits of the "Record III" modified for "free" grid bias.

RULES.

- (1.) A query must be accompanied by a COUPON removed from the advertisement pages of the CURRENT ISSUE.
- (2.) Only one question (which must deal with a single specific point) can be answered. Letters must be concisely worded and headed "Information Department."
- (3.) Queries must be written on one side of the paper and diagrams drawn on a separate sheet. A self-addressed stamped envelope must be enclosed for postal reply.
- (4.) Designs or circuit diagrams for complete receivers or eliminators cannot ordinarily be given; under present-day conditions justice cannot be done to questions of this kind in the course of a letter.
- (5.) Practical wiring plans cannot be supplied or considered.
- (6.) Designs for components such as L.F. chokes, power transformers, complex coil assemblies, etc., cannot be supplied.
- (7.) Queries arising from the construction or operation of receivers must be confined to constructional sets described in "The Wireless World"; to standard manufactured receivers; or to "K.U." sets that have been reviewed.

Accumulator H.T. Supply.

My problem is somewhat similar to that of "S. F. F.," which was published in your issue of June 4th, but in my own particular case I have to feed the anodes of all the valves with the maximum voltage supplied by my accumulator H.T. battery (150 volts) while a lower pressure is required only for the screening grid of the two H.F. amplifiers.

Would you recommend me to provide a separate tapping, or to feed the screening grid through a voltage-absorbing resistance? J. A. H.

In this case we think it would be both better and simpler to provide a separate connection to the battery for the screening grid circuits: a simple series resistance for reducing voltage would be hardly satisfactory, and a potentiometer, although providing good regulation, seems to be unnecessarily complicated and extravagant.

o o o o

Controlling a Superheterodyne Oscillator.

My superheterodyne short-wave adaptor, as described in your issue of April 23rd, is working satisfactorily, except when an attempt is made to receive the lower band of wavelengths within its compass. On this band it seems most difficult to control the oscillator valve, which passes directly from a state of non-oscillation into a condition where its anode current, as indicated by the meter, amounts to 10 milliamperes, or even more. Will you please suggest what is wrong? H. H. A.

This may be due to several causes, and we suggest that you pay attention to the following points:—

- (1) The oscillator valve should have an impedance not appreciably greater than the value suggested.
- (2) Excessive aerial loading may be responsible, and, to test whether this is so, the aerial should be completely disconnected. If oscillation control is then found to be normal, a very small aerial condenser should be inserted in the aerial circuit.
- (3) The H.F. choke may be faulty, or, at any rate, its characteristics may be unsuitable for use with the particular reaction winding specified.

A Free Wavelength.

In the description of the Superheterodyne Short Wave Adaptor in your issue of April 23rd last it is stated that before the unit is connected the broadcast set with which it is used should be carefully tuned to a free wavelength of between 1,500 and 2,000 metres. If possible, will you please amplify this statement, as I am not sure of the right method to adopt?

T. W. M.

By a "free" wavelength is meant one on which strong interference is not likely to be experienced. Of course, in the absence of a radiating wavemeter, you cannot accurately tune the set without listening to actual signals. The best procedure is to find a weak morse transmission and to adjust the tuning condensers until this transmission is heard at maximum strength before connecting the superheterodyne unit.

o o o o

Needle Scratch.

When my set is used for gramophone reproduction with a reed-driven cone loud speaker, needle scratch is not evident, but it is loud enough to be annoying when a moving-coil loud speaker is substituted. Can you explain why this should be? I should add that the moving-coil instrument gives appreciably more satisfactory results than the other when wireless signals are being received.—W. D.

It seems possible that your moving-coil loud speaker may have a resonance that happens to coincide more or less with the frequency of needle scratch, or simply that this instrument reproduces the higher frequencies better than does the other.

If a resonance effect is responsible, it would be wise to attempt, either by electrical or mechanical means, to shift the point of this resonance. You might

should pay attention to the alignment of your pick-up carrier.

o o o o

The Unit H.F. Amplifier.

My present local-station receiver has an anode bend detector followed by two low-gain L.F. stages, and is tuned by means of a standard "Everyman Four" aerial-grid transformer and variable condenser. Do you think that this set as it stands could be operated in conjunction with the H.F. amplifying unit described in your issue of May 21st, 1930? H. H. A.

Yes, this unit should work well in conjunction with your receiver, but the primary impedance of your aerial-grid transformer is much too low for connection in the anode circuit of an S.G. valve—as it virtually is when the output terminal of the unit is joined directly to the aerial terminal of the set. This disability may be overcome by joining the normal amplifier output terminal to the grid of your detector. If instability is found to result, due to the fact that the dynamic resistance of the tuned grid circuit is too high, the simplest way of correcting it would be to reduce the capacity of the feed condenser (C4 in the published diagram of the amplifier).

o o o o

"Power Pentode Two" with Triode Output.

I take it that there is no real reason why an indirectly heated triode should not be used as an output valve in the "Power Pentode Two," described in your issues of May 7th and 14th? If this is correct, will you please give me a diagram showing the necessary alterations?

P. W.

Due to the fact that this receiver is essentially designed for a pentode, several

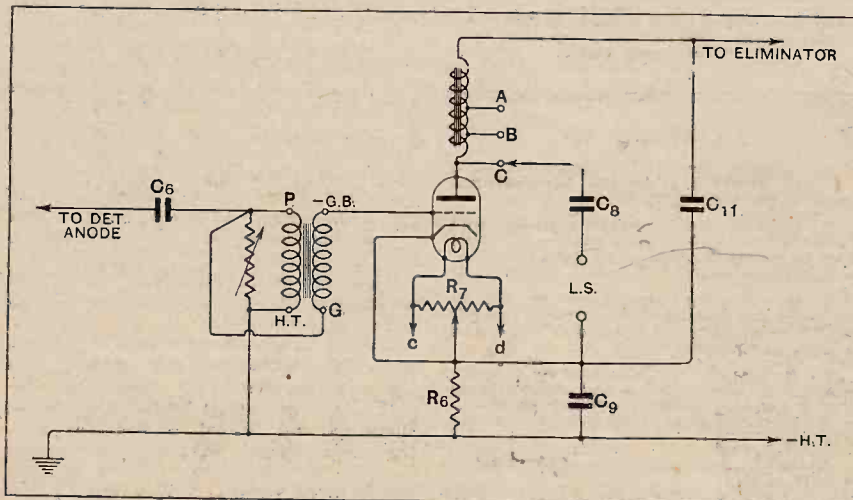

Fig. 2.—Appropriate circuit alterations when a pentode output valve is replaced by an indirectly heated triode.

also try to reduce the general level of high-note response of your L.F. amplifier, but before doing so we suggest that you

alterations will be necessary if a triode output valve be substituted. These modifications are shown in Fig. 2.

FOREIGN BROADCAST GUIDE.

ECOLE SUPÉRIEURE DES POSTES ET TÉLÉGRAPHES (FPTT)

PARIS (France).

Geographical Position: 48° 51' 30" N.
2° 17' 43" E.

Approximate air line from London: 214 miles.

Wavelength: 447 m. Frequency: 671 kc.
Power: 3 kW.

Time: * Greenwich Mean Time.

* France adopts British Summer Time.

Standard Daily Transmissions.

08.00 and 09.25 B.S.T., News and Time signal; 12.00 weather, concert; 17.00 concert (outside broadcast on Saturdays); 17.30 language lesson (English, German, Spanish or Esperanto); 20.30 or 21.00 Main evening programme; 22.30-24.00 dance music (Wed. and Sat.).

Male announcer only. Call: *Ici les transmissions de T.S.F. du réseau français de radiodiffusion des stations de l'Ecole Supérieure et de la Tour Eiffel.* When the broadcast is relayed to the provincial transmitters the call is altered to: *Ici l'ensemble des stations de radiodiffusion du réseau de l'Etat français.*

Time Signal: Carillon de Fontenay (Clock with chimes).

No regular opening or interval signal, but on occasion to open transmission a gramophone record is played.

Closes down with *La Marseillaise* and usual French good-night formula (*wide Radio Paris*).

Relays: Toulouse (255 m. 1,175 kc.); Lille (265.4 m. 1,130 kc.); Rennes (272 m. 1,103 kc.); Montpellier (286 m. 1,049 kc.); Limoges (293 m. 1,022 kc.); Bordeaux-Lafayette (304 m. 986 kc.); Marseilles (316 m. 950 kc.); Grenoble (328.2 m. 914 kc.); Lyon-la-Doua (466 m. 644 kc.); and Eiffel Tower, Paris (1,445.7 m. 207.5 kc.).

In the first place, it is generally of advantage to provide a "rising" L.F. amplification characteristic, and so the L.F. transformer connections should be modified as shown; this gives the circuit arrangement of Fig. 4B of the original article in which the "Power Pentode Two" was described.

The average loud speaker is designed to match the average impedance of a triode valve, and so a step-down output filter will no longer be necessary, and the loud speaker will be joined to the anode end of the choke.

Similarly, a tone-lowering device is unlikely to be of advantage in a receiver modified as you propose, and so we have omitted the connections for this as given in the original circuit diagram.

The value of the bias resistance R_6 will almost certainly need some alteration, its precise value depending upon the type of valve used and its operating conditions.

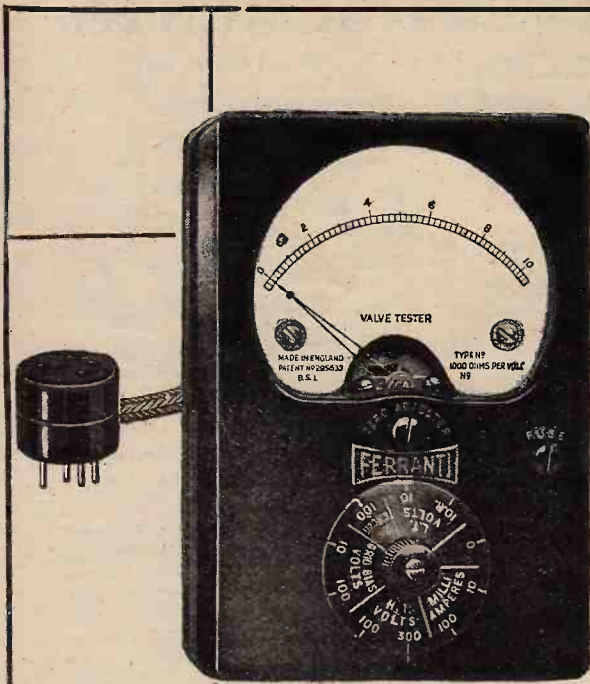

FERRANTI VALVE TESTER

A unique instrument of great utility to the expert and amateur. An invaluable aid in servicing and operating Receivers and Amplifiers.

Measures H.T., L.T. and G.B. Voltages and H.T. Milliamps. Adapter enables measurements to be taken on A.C. Mains Sets (except Cathode volts and amps.). This instrument is in accordance with the requirements of the British Engineering Standards Specification for First Grade Multi-range Instruments.

RANGES :

Type VT1. 0-10-100 Milliamps. and 0-10-100-300 Volts.
Type VT2. 0-10-100 Milliamps. and 0-10-100-500 Volts.

RESISTANCE : 1000 Ohms per Volt.

PRICES :

300 Volt Type VT1 £7-5-0
500 Volt Type VT2 £11-0-0
Adapter for use with A.C. Valve 15-0

Ask for List W 418/1.

FERRANTI LTD.

HOLLINWOOD

LANCASHIRE

LISTEN AT LESS COST

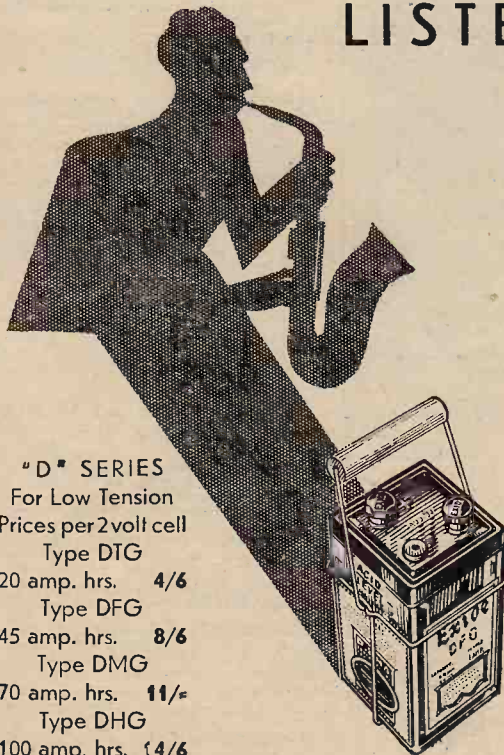

"D" SERIES
For Low Tension
Prices per 2 volt cell
Type DTG
20 amp. hrs. 4/6
Type DFG
45 amp. hrs. 8/6
Type DMG
70 amp. hrs. 11/-
Type DHG
100 amp. hrs. 14/6

Nowadays most valves take far less current than they used to take. Batteries could now last for a very long time on one charge if only they would not deteriorate when not charged frequently. Always a step in front, Exide have designed a new type of low tension battery with special plates to give slow discharges for long periods without harm. With one of these batteries—known as the "D" series—listening will cost you much less—less in money—less in trouble.

Exide

THE LONG LIFE BATTERY

Obtainable from Exide Service Stations and all reputable dealers
Exide Service Stations give service on every make of battery

Exide Batteries, Clifton Junction, near Manchester. Branches at London, Manchester, Birmingham, Bristol and Glasgow

MISCELLANEOUS ADVERTISEMENTS.

NOTICES.

THE CHARGE FOR ADVERTISEMENTS in these columns is:

12 words or less, 2/- and 2d. for every additional word.

Each paragraph is charged separately and name and address must be counted.

SERIES DISCOUNTS are allowed to Trade Advertisers as follows on orders for consecutive insertions, provided a contract is placed in advance, and in the absence of fresh instructions the entire "copy" is repeated from the previous issue: 13 consecutive insertions 5%; 20 consecutive, 10%; 52 consecutive, 15%.

ADVERTISEMENTS for these columns are accepted up to **FIRST POST ON THURSDAY MORNING** (previous to date of issue) at the Head Office of "The Wireless World," Dorset House, Tudor Street, London, E.C.4, or on **WEDNESDAY MORNING** at the Branch Offices, 19, Hertford Street, Coventry; Guildhall Buildings, Navigation Street, Birmingham; 280, Deansgate, Manchester; 101, St. Vincent Street, Glasgow, C.2.

Advertisements that arrive too late for a particular issue will automatically be inserted in the following issue unless accompanied by instructions to the contrary. All advertisements in this section must be strictly prepaid.

The proprietors retain the right to refuse or withdraw advertisements at their discretion.

Postal Orders and Cheques sent in payment for advertisements should be made payable to **ILLIFFE & SONS Ltd.,** and crossed. Notes being untraceable if lost in transit should not be sent as remittances.

All letters relating to advertisements should quote the number which is printed at the end of each advertisement, and the date of the issue in which it appeared.

The proprietors are not responsible for clerical or printers' errors, although every care is taken to avoid mistakes.

NUMBERED ADDRESSES.

For the convenience of private advertisers, letters may be addressed to numbers at "The Wireless World" Office. When this is desired, the sum of 6d. to defray the cost of registration and to cover postage on replies must be added to the advertisement charge, which must include the words Box 000, c/o "The Wireless World." Only the number will appear in the advertisement. All replies should be addressed No. 000, c/o "The Wireless World," Dorset House, Tudor Street, London, E.C.4. Readers who reply to Box No. advertisements are warned against sending remittance through the post except in registered envelopes, in all such cases the use of the Deposit System is recommended, and the envelope should be clearly marked "Deposit Department."

DEPOSIT SYSTEM.

Readers who hesitate to send money to unknown persons may deal in perfect safety by availing themselves of our Deposit System. If the money be deposited with "The Wireless World," both parties are advised of its receipt.

The time allowed for decision is three days, counting from receipt of goods, after which period, if buyer decides not to retain goods, they must be returned to sender. If a sale is effected, buyer instructs us to remit amount to seller, but if not, seller instructs us to return amount to depositor. Carriage is paid by the buyer, but in the event of no sale, and subject to there being no different arrangement between buyer and seller, each pays carriage one way. The seller takes the risk of loss or damage in transit, for which we take no responsibility. For all transactions up to £10, a deposit fee of 1/- is charged; on transactions over £10 and under £50, the fee is 2/6; over £50, 5/-. All deposit matters are dealt with at Dorset House, Tudor Street, London, E.C.4, and cheques and money orders should be made payable to Illiffe & Sons Limited.

SPECIAL NOTE.—Readers who reply to advertisements and receive no answer to their enquiries are requested to regard the silence as an indication that the goods advertised have already been disposed of. Advertisers often receive so many enquiries that it is quite impossible to reply to each one by post.

"WIRELESS WORLD" INFORMATION COUPON

This Coupon must accompany any Question sent in before

JULY 2nd, 1930

For Particulars of Free Service, see Rules on page 683.

Mention of "The Wireless World," when writing to advertisers, will ensure prompt attention

POWER CHOKES

guaranteed two months substantially built, for smoothing circuits in eliminators dealing with currents 100 to 300 milliamperes, inductance 30 henries, post free

8/6

Note change of address to any make of L.F. Transformer, Loudspeaker or Headphones. All repairs dispatched within 48 HOURS. TWELVE MONTHS' GUARANTEE with each repair. 4/- Post Free. Terms to Trade.

TRANSFORMER REPAIR CO.
Dept. W.,
953, GARRATT LANE, TOOTING, LONDON, S.W.17.

WANTED.

A satisfactory means of obtaining new radio material with economy by owner of valuable but unwanted radio apparatus. The means must be without trouble or risk, and must provide a good allowance for his unwanted material, and must also provide, if required, for delivery in various parts of the world. (Recommended to utilise the service of APPLEBY'S, Chapel Street, Marylebone, London, the first and largest radio part exchange service. Particulars upon application.)

SURPLUS STOCK OF POLISHED MAHOGANY CABINETS.

Height 34", Width 16",
Depth 18".

Fine Cabinet Work, suitable for Gramophone or Wireless Installation, Smokers' Cabinet, Pedestal Cupboards, etc.

29/6 EACH TO CLEAR.

Less than half actual factory cost.

Packing and carriage 5/- extra, any station United Kingdom. Cash with order.



THE AEOLIAN CO., LTD.,
131-7, NEW BOND ST., LONDON, W.1.

BAUGATZ CONDENSERS



1,500 v. D.C. Test As specified in "The Wireless World" for "New Foreign Listener's Four" also

Non-inductive type 700 D.C. in Bakelite Case. 1 µf.—2/6, 2 µf.—3/6, 4 µf.—4/3. A. M. E. SHERWOOD, 66, Hatton Garden, London, E.C.1.

LOGGING MADE EASY

By the Polar Tuning Graph which enables you to record and immediately identify any station by its wavelength. Send 2½d. stamp to Dept. W.

WINGROVE & ROGERS Ltd.
188-9, Strand, London, W.C.2



RECEIVERS FOR SALE.

SCOTT SESSIONS and Co., Great Britain's Radio Doctors.—Read advertisement under Miscellaneous.

HIRE a McMichael Portable Set, by day or week, from Alexander Black, Wireless Doctor and Consultant, 55, Ebury St., S.W.1. Sloane 1655. [0264, 0328]

PHOENIX Master 3-star Kits, complete with cabinet, £22/2; ditto, with valves, £21/7/6; ditto, with H.T. and L.T. batteries and speaker, £4/5.—Phoenix, 314, High Rd., Lee, S.E.13. [9704]

THERE is No Better Method of Purchase than Purchase by Part Exchange Through a Service Properly Conducted; it will be definitely to your advantage to utilise the radio part exchange and banking facilities offered in the name of Appleby; thousands of your fellow readers do, and have done for years; part exchange credit notes worth thousands of pounds have been duly honoured upon presentation; not a single item of customers' property has ever been lost or mislaid.—Particulars of this part exchange service, the first and largest in existence, will be forwarded upon request to The Secretary, Appleby's, Chapel St., Marylebone, London. [0338]

IGRANIC Neutrosnic 7-valve Receiver, complete with batteries, speaker, and all the necessary accessories, an additional frame aerial, folding type, Igranic; also Marconi moving coil speaker, D.C. model, mahogany; £20, or offers.—C. E. B., Flat B, Dudley House, Barton St., West Kensington, W.14. [9774]

FOR Sale.—Amplion Five 5-valve 4-stage 2-output Minor Amplifier and Twin Output Motor Generator, complete with field starter and regulator with Amplion filter unit, inspection invited; cost £200.—For full particulars, phone Western 7067 between 9 and 6. [9773]

ALL Mains Portable, D.C. or A.C., any voltage, 5-valve, speaker incorporated, no batteries used, silent, powerful, selective; £16/16; illustrated leaflet post free, or call.—I. D. S., 4, Golden Sq., London, W.1. [9767]

£17/17.—5-valve portable set in oak cabinet, as new; price £13; sent for trial anywhere.—Stott, Clare Hill, Huddersfield. [9764]

MARCONIPHONE 56 Receiver, D.C. model, full equipment, perfect, only 4 months old; £22.—Wood, Duke of York, Grimsby. [9790]

AN Unique Opportunity.—Burndept, latest model, Universal Screened Five for A.C. mains, covers three wavelengths 16-38, 220-560, 900-2,100 without coil changing, three degrees of selectivity on each wavelength, very powerful, only used one month; cost £43, bargain £28/10; first cheque secures.—Box 6527, c/o The Wireless World. [9808]

TRUPHONIC 5-valve Portable Handsome Lacquer Case, suitable wireless expert; £6.—Apply letter, 27, Hallycroft Av., Hampstead, N.W.3. [9786]

BERCLIF D.C.2 All Mains Receiver, 200 to 250 volts D.C.; price £14/10; with valves and royalties, suitable for M.C. speaker; particulars free; trade inquiries specially invited.—Simmonds Bros., Shireland Rd., Smethwick. [8734]

YOUR Old Receiver or Components Taken in Part Exchange for New, write to us before purchasing elsewhere, and obtain expert advice from wireless engineer of 25 years' professional wireless experience; send a list of components or the components themselves, and we will quote you by return post; thousands of satisfied clients.—Scientific Development Co., 57, Guildhall St., Preston. [0226]

ACCUMULATORS—BATTERIES.

10 Exide W.J.10 High Tension Accumulators, dry; 4/- each, post extra.—Godfrey, 4, High St., Hampstead. [9820]

ACCUMULATOR HIRE.

DON'T Buy Accumulators or Dry Batteries, join our C.A.V. low- and high-tension accumulator hire service, the largest and best in London; better and cheaper reception with no trouble; regular deliveries within 12 miles of Charing Cross; no deposit, payment on each delivery or by quarterly subscription; over 10,000 satisfied users; explanatory folder post free; phone or write to-day.—Radio Service (London), Ltd., 105, Torrington Av., N.W.5. 'Phone: North 0623-4-5. [8751]

CHARGERS AND ELIMINATORS.

TANTALUM and Liumion for A.C. Rectifiers; for inexpensive chargers; blue prints for H.T. and L.T., 1/- each; Liumion electrodes, 2-3 and 5-8 amps.—Blackwells Metallurgical Works, Ltd., Garston, Liverpool. [8298]

SAVAGE Transformers and Chokes.

STOCKTAKING.—The following new transformers are for sale owing to alteration of models: 22T20, 14T21, 12T22, and 5T23; also 34G and C28G chokes, all by Savage, of Bishopsgate.—Apply to Parjay, 8, Bridewell Place, Ludgate Circus, E.C.4. [9731]

Chargers and Eliminators.—Contd.

PHILIPSON'S Safety High Tension Supply Units for A.C. and D.C. Mains, 200-250 volts 40-60 cycles, also 230 volts 25 cycles.

10/- Down and Small Monthly Payments Secures the Finest H.T. Supply Available.

PHILIPSON'S Safety H.T. Units are Guaranteed for 12 Months Against All Defects.

ALL Models Sold on 7 Days' Approval to Ensure Complete Satisfaction.

PHILIPSON'S Safety H.T. Units are the Cheapest to Install and the Cheapest to Run; £1/17/6 to £6.

WRITE for Our Booklet "Radio Power," which gives illustrations and full particulars.

PHILIPSON'S Safety Loud Speaker Output Filters for All Receivers, power valve, or Pentode; a remarkable output filter at a very low price; 16/6.

PHILIPSON and Co., Ltd., Radio Engineers, Astley Bridge, Bolton. 'Phone: 2038 Bolton. 10318

ACVOKE L.T. Charger, rotary, operates on 220v. D.C., and provides 25v. 10 amps., complete with charging board, meters, etc.; cost over £30, will accept £10, or offer.—Norton, High St., Porlock, Somerset. [9783

FERRANTI A.C. Mains Unit, unused; what offers? —20, Manor Rd., Salisbury. [9770

B.T.H. Tungar Charger, H.T. and L.T. type, for A.C., 230-250 volts 50 cycles; cost £8/15, with spare valve, best offer over £4/10 secures.—Box 6436 c/o *The Wireless World*. [9763

ONE Marconi D.C.1 All Power D.C. Mains Unit, for H.T., L.T. and G.B., from 200-250 volts D.C. mains, perfect, hardly used; ordinary price £6, offered at 60/.—Godfrey, 4, High St., Hampstead. [9819

SAVAGE'S Specialise in Wireless Power from the Mains; reliable apparatus at reasonable prices.

SAVAGE'S—Transformer laminations and Bakelite bobbins; intending home constructors should write for list.

SAVAGE'S—Reliable smoothing condensers, 1,500 volt D.C. test, 1 mid., 2/; 2 mid., 3/; 4 mid., 5/3; 500 volt D.C. test, 1 mid., 1/6; 2 mid., 2/3; 4 mid., 3/9.

SAVAGE'S—Super smoothing and output chokes, many types available; write for list.

SAVAGE'S—Mains transformer for Westinghouse H.T.4 unit, with additional winding, 4 volts centre tapped 3 amps, 23/-; transformers for other Westinghouse units available.

SAVAGE'S—Mains equipment for new Foreign Listeners Four, transformer N.F.L.4, 33/-; smoothing choke, C32G, 20/-; output choke C32O, 20/-.

SAVAGE'S—Mains equipment for Power Pentode Two transformer, P.P.2, 33/-; output choke, L.C. 36P.G., 19/6; smoothing choke, L.C.36G, 18/-.

SAVAGE'S—Mains transformer B.T.4, 500-0-500 volts, 120 m. amps, 7½ volts 3 amps, 6 volts 3 amps, 4 volts 2 amps., 4 volts 1 amp, 4 volts 1 amp., all centre tapped, specially developed for automatic bias; 57/6.

SAVAGE'S—Mains transformers and power chokes are carefully and individually constructed from first class materials, with an exceptionally generous margin of safety.

SAVAGE'S, 146, Bishopsgate, London, E.C.2. 'Phone: Bishopsgate 6998. [9165

NEW Goods.—Ediswan charger, 2 to 12 volts at 2 amps. A.C., 50 cycles, 28/-; 3 Jelectro unspillable accumulators, 2-volt 60 amps, cost 23/-, take 10/- each; 1 P.M. R.C. unit, 17/6, take 8/-.—Newth, 31, George Street, Hanover Sq., London, W. [9827

IGRANIC Combined H.T. Unit and L.T. Battery Charger, 6-volt accumulators automatically charged; cost £16/10, accept £6; also P. and R. 80 amp. indicating accumulator in carrying case, £2/10.—Box 6528, c/o *The Wireless World*. [9809

CHESTER BROS.—All types of mains transformers and chokes to any specification.—Chester Bros., 244, Dalston Lane, London, E.8. [9798

ZAMPA H.T. Eliminator Kit, comprising rectifying unit (incorporating transformer, condensers, Westinghouse H.T.3), necessary condensers, choke, terminals, baseboard, etc., output 120 volts at 20 ma.; complete 45/-; seven days' approval against cash; other Zampa kits and transformers on request.—Mic Wireless Co., Market St., Wellingborough. [9797

400 Volts 80 ma. and 2 Variable Tappings, input 200-240 volts 40-100 cycles; £7; cost double. perfect.—Rogers, 21, New Rd., Brentwood. [9794

CABINETS.

CABINETS for All Requirements.—F. W. Ramsey, 63, Shaftesbury St., London, N.1. Clerkenwell 7139. [9736



"ECHOPHONE"
DOMESTIC & OFFICE
TELEPHONE
Calling and Speaking
both ways. The most
economical and reliable
private Telephone
known.

So sensitive that conversation can be carried on in a whisper. The New "ECHOPHONE" eliminates the most unreliable part of all small telephones, i.e. the electric bell call. An entirely new call system is employed—discreet yet sufficiently loud to attract attention.

NO BREAKDOWNS owing to corroded electric bell or spring contacts are possible; such contacts are entirely avoided in the "ECHOPHONE." There are no delicate mechanical parts likely to get out of order. Each pair of Instruments is **GUARANTEED FOR 2 YEARS.**

PRICE, including 25 yards connecting wire,
Per Pair **28/6**

Extra connecting wire 2d. per yard.

Any small pocket battery will operate the "ECHOPHONE" for many weeks, or we can supply two Dry Cells lasting 18 months for 3/-.

CAN BE INSTALLED BY ANYONE IN LESS THAN 1 HOUR.

FREDK. ADOLPH, Actual Maker, 'Phone: 27, Fitzroy Street, London, W.1. Museum 8329.

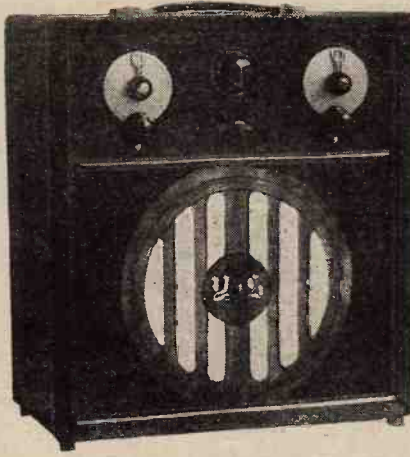

20 Guineas.
3-Valve All-Electric
Transportable, complete with built-in Loud Speaker. Entirely self contained.

Dual-wave range. Variable selectivity for all conditions of service. Universal Mains Transformer for 200-220-240 A.C. 50 Cycles. Mazda Mains Valves S.G., D. and Super Power. Parmeko Mains Equipment. Height 15½". Width 14½". Depth 7½". Weight 25 lbs.

YATES SUTTON LIMITED,
38-42, YORK STREET, LEICESTER.

Cabinets.—Contd.

DIGBY'S Cabinets.—Table models in solid oak and mahogany, from 11/6 to 71/-.

DIGBY'S Cabinets, fitted with Radion or Resiston ebonite if required.

DIGBY'S Cabinets.—Pedestal model, with separate battery components; from 56/- to £12.

DIGBY'S Cabinets Made to Customers' Own Designs.

DIGBY'S Cabinets.—Write for new 16-page art catalogue.—F. Digby, 9, The Oval, Hackney Rd., E.2 'Phone: Bishopsgate 6458. [0128

KAY'S Cabinets, the greatest range of pedestal cabinets in the kingdom; original creative designs at prices 50% lower than elsewhere; quotations for specials by return; delivery at short notice guaranteed.

RADIOGRAM Cabinets.—A variety of really practical and exclusive models from 60/-; illustrated lists free.

H. KAY, Wireless Cabinet Manufacturer, Mount Pleasant Rd., London, N.17. 'Phone: Walthamstow 1626. [8963

COILS, TRANSFORMERS, ETC.

TRANSFORMERS and Chokes for Battery Eliminators.—Chester Bros., 244, Dalston Lane, London, E.8. [9706

BERCLIF Coils, the standard of excellence, for all "Wireless World" receivers; latest lists post free; trade supplied, all quantities.—Simmonds Bros., Shireland Rd., Smethwick. [8735

DYNAMOS, ETC.

ONE Crypto Rotary Converter and Starter, input 240 volts D.C., output 1 amp. at 200 volts 50 cycles single phase A.C., scarcely used; £10, carriage forward.—Godfrey, 4, High St., Hampstead. [9823

GRAMOPHONES, PICK-UPS, ETC.

AMPLION Pick-up, with adaptor; 12/6.—Webb, "Venmore," Dunmow. [9771

TWO Phonovox Pick-ups, with E.M.G. arms, 25/- each; 1 Phonovox pick-up, with Meltrope arm, 22/6; the above tuned for fibre needles; 1 Bowyer-Lowe pick-up and arm, 15/-; 1 Woodroffe pick-up and Kusha arm, 45/-; 1 Blue Spot pick-up and Kusha arm, 18/6; 1 Kusha arm, 7/6.—Godfrey, 4, High St., Hampstead. [9817

COLUMBIA 3/- Records, about 300 to clear, guaranteed new, from May, 1929, to date, unselected titles 18/-, selected 24/- per doz., carriage paid; for less than 1 doz. include 1/- postage; stamp for list.—Box 6530, c/o *The Wireless World*. [9811

SNIP—As brand new, B.T.H. 6 guinea electric gramophone motor, A.C. or direct, any voltage, automatic switch; 3 guineas.—46, Princes Boulevard, Higher Bebington. [9802

NOVOTONE, £3/10, perfect; R.I. Varley tone arm, £1; B.T.H. pick-ups, newest pattern, 30/-; old pattern, 10/-; complete with tone arms.—Rogers, 21, New Rd., Brentwood. [9795

VALVES.

L.S.5A (new), 15/-; D.E.4, 3/-; P.M.5B, 3/-; D.E.5B, 3/-.—Webb, "Venmore," Dunmow. [9772

12 L.S.5A Valves, 1 S625 valve; all at 10/- each.—Godfrey, 4, High St., Hampstead. [9822

ALL New, unboxed.—1 P.M.5B, 1 P.M.6D, 1 H210, 5/- each; 2 P.M.16s, 2 S215s, 11/- each; 1 P610, 6/-; 1 P625, 1 P240, 7/- each.—Newth, 31, George St., Hanover Sq., London, W. [9826

FILAMENT Volts 6, plate volts 400 (maximum), grid bias 84 volts (approx.), impedance 800 ohms, amplification factor 3.8, mutual conductance 4.35 m.a./volts; price £5/10; see article "The Wireless World," 24th July, 1929, then send to North London Valve Co., Ltd., 22½, Cazenove Rd., Stoke Newington, London, N.16. [9812

3 METRO-VICK A.C. Screened Grid Valves, never been used, perfect, 10/- each; Marconi H.L.B. P.8, 2/6 each.—Rogers, 21, New Rd., Brentwood. [9796

LOUD-SPEAKERS.

BAKER'S SELHURST RADIO 36-page Booklet, "Sound Advice is Yours for the Asking"; write now for new edition; see displayed advertisement on page 13. [0231

ONE Magnavox R4 Speaker, for 6-volt field, with nice 30in. baffle, 80/-; carriage forward; 1 field coil, 6-volts 0.6 amps., for "Wireless World" speaker, 10/-; 1 aluminium frame and stand, Baker type, for 5¼in. pot, 7/6.—Godfrey, 4, High St., Hampstead. [9818

AMPLION Lion, new condition, chassis only; £2/10.—Raymond Amis, 29, Maybank Rd., South Woodford, Essex. [9824

Loud-Speakers.—Contd.

EPOCH Moving Coil Speakers are Masterpieces, designed and produced by master engineers.

EPOCH Moving Coil Speakers are the Standard by which other Speakers are Compared.

EPOCH Moving Coil Speakers are in Use in Many Editorial Offices.

EPOCH Moving Coil Speakers are in Use in Several Famous Laboratories.

EPOCH Moving Coil Speakers are in Use in Many Broadcasting Stations.

EPOCH Moving Coil Speakers are in Use by Most Prominent Musicians.

EPOCH Moving Coil Speakers Bring Unbounded Joy to Thousands upon Thousands of Homes.

EPOCH Moving Coil Speakers, the only speakers that give clear, uncoloured reproduction.

EPOCH Moving Coil Speakers do Render Speech Perfectly and Music Correctly.

EPOCH Moving Coil Speakers Provide the Perfect Illusion of the Artist's Presence.

EPOCH Moving Coil Speakers Represent the Finest Intrinsic Value Ever Offered.

EPOCH Moving Coil Speakers are Guaranteed for a Year, but last for ever.

EPOCH Moving Coil Speakers Bring the Grand Concert out of the Most Modest Set.

EPOCH—You can hear a hundred moving coil speakers, but Epoch is different.

EPOCH—If you own the best set, only by Epoch can you confirm it.

EPOCH—Away with the tin can and cracked banjo reproduction, and install an Epoch.

EPOCH—Away with the drumminess, droniness, and huskiness of the average moving coil speakers.

EPOCH—The clearest, sharpest, cleanest reproduction—a marvel of accuracy and beauty.

EPOCH Moving Coil Speaker Models from £2/10 to £30.

EPOCH Moving Coil Speakers.—Models for every requirement and taste.

EPOCH Permanent Magnet Moving Coil Speakers.—Nine models from £3/15.

EPOCH Permanent Magnet Moving Coil Speakers Require no Mains or Batteries.

EPOCH Permanent Magnet Speakers are more Sensitive than most Energised Moving Coil Speakers.

EPOCH Energised Models are the Finest ever put on the Market.

EPOCH Super Cinema Speaker has Created the Biggest Sensation for Many Years.

EPOCH Super Cinema Model is many times as Sensitive as the so-called Supers.

EPOCH Super Cinema Speakers give Enormous Volume from a 1-watt Amplifier.

EPOCH Super Cinema Speakers are used on many 100-watt Amplifiers and never "rattle."

EPOCH Super Cinema Model is Standard on several Talkie Equipments.

EPOCH Super Cinema Model is already in use in over 200 Cinemas.

EPOCH Super Cinema are the only Moving Coil Speakers used in Large Theatres, unaided.

EPOCH Super Cinema Speakers provide alone the Upper as well as the Lower Register.

EPOCH—Other Moving Coil Speakers require the help of exponential horns to provide depth.

EPOCH—A list of many prominent cinemas using the Speakers supplied on request.

EPOCH Speaker — not Made of Tin or Aluminium Stampings, but are sound, solid, engineering jobs

EPOCH Heartily Invite Comparison, on all counts, with any make, regardless of price or claims.

EPOCH—Don't accept our quality claims without verification, but don't accept any other maker's either.

EPOCH—Order one on 7 days' approval, and test with a "witch-over," the only real test.

EPOCH Moving Coil Speakers may be heard in our Demonstration Room Daily.

EPOCH—Our demonstration room is in the heart of London.

EPOCH—Its accessibility has been studied for the convenience of callers.

EPOCH—If you cannot call, write for booklet W.S.3, and approval terms.

EPOCH RADIO MANUFACTURING Co., Ltd., Farringdon Av. (near Ludgate and Holborn Circus). Phone: Central 1971. [8983

COMPONENTS, ETC., FOR SALE.

BELLING-LEE Panel Fittings, are designed to give an expert finish to any home-constructed set; catalogue post free.—Belling and Lee, Ltd., Queensway Works, Ponders End, Middlesex. [0018

COMPONENTS Lent on Hire.—Details from Alexander Black, Wireless Doctor, 55, Ebury St., S.W.1. Sloane 1655. [0329

SOLDER, specially prepared for radio joints. 2ft. strip; 6d., post free.—C. O. Pattison, 548, Shields Rd., Newcastle-on-Tyne. [9716

R.K. Senior 200v., D.C., £3/10; Gambrell Novotone, A.C., £2/10; M-L converter, 200v. D.C. input, 230v. A.C., 85 watts output, £11; all-electric gramophone with R.K. amplifier and moving coil for A.C., £25; A.C. radio-gramophone, £45; walnut Panatone, D.C. model, £25; Rothermel power amplifier, less valves, £2/15; Tungar trickle charger, £1.—F. Hills, 13, Golden Sq., W.1. [9765

ONE P.A.M. 17 Amplifier, less valves; 1 Magnavox X core dynamic speaker, 180 to 300 volts D.C.; 1 Webster pick-up; 1 Novotone; all the above are in splendid condition, almost brand new, and can be seen at any time at Messrs. Jack Barclay, 12a, George St., Hanover Sq., W.1. [9776

B.T.H. Pick-up, large Collaro gramophone motor, A.F.3, Westinghouse A3, A4, with mains transformers, Metro-Vick H.T. and L.T. mains transformer. P.M.14, P.M.24, P.625. Wanted, Magnavox M.C.—Scott, 10, East Parade, Ilkley. [9777

SURPLUS, cheap.—Eliminators, valves, units, chassis, choke coils; stamp list.—Radio, 3, Elmhall Drive, Mossley Hill, Liverpool. [9784

MAINS Transformers, 240v. input, output 200v., 50mA., and 200v., 100 mA., with U5 valve, £1 each; moving coil pot, 8/—Cook, 29, Park Rd., Haringay, N.15. Phone: Mountriview 6931. [9785

FERRANTI 0.15 mA., 15/-; Marconi Ideal transformer, 15/-; Clorostat, 3/-; Mullard Permacore, 16/-; other accessories cheap.—Wyer, High St., Hunstanton. [9781

ONE G.E.C. 3-stage Choke, coupled L.F. amplifier unit, 40/-; 1 Ediswan R.C.C. unit, 4/-—Godfrey, 4, High St., Hampstead. [9821

SALE of Amateur's Surplus Apparatus.—Pye L.F. choke, 5/6; R.L. Pentamou pentode output transformer, in original box, 15/-; Gambrell Novotone, £3; 2 Dubilier 1,000 mfd. electrolytic condensers, 10/- each; Cossor 2v. S.G. valve and holder, 5/-; Loewe 3N.F. valve, unused, £1; M.S.4 valve, 15/-; 354v. valve, 10/-; M.H.4 valve, 10/-; 9 B type 1,000v. transmitting valves, ex-Government, 3/- each; Ferranti A.F.5C transformer, 17/6; Mazda A.C.S.G. valve, 10/-; B.T.H. R.K. speaker (case slightly damaged), £1/15; Burdett needle armature pick-up, £1/5; Ferranti O.P.3C transformer, 17/6; 3 S.625 valves and holders, 10/- each; set of 4 Bowyer-Lowe intermediate frequency superheterodyne transformers, short wave oscillator coils for same, 5/-; several Becol low loss formers, 3in. x 4in., ribs have been slotted, 1/-; brand new M-L converter, fitted complete in box, with smoothing condensers, only been used for one demonstration, £15; Heayberd transformer, input 200 volts, output 150-0-150v. 10 ma., 2.5-0-2.5, 2 amps, 12/-; ditto, input 230v., 12/-; ditto, input 110v., 12/-; quantity fixed condensers by various good makers, 0.0001, 0.0005, 0.0003, 10d. each; quantity 2 meshan grid leaks by various good makers, 8d. each; 2 Graham-Farish Paxolin dielectric variable condensers, 0.0005, without dials, 2/-; 2 Graham-Farish Paxolin dielectric variable condensers, 0.0001, without dials, 2/-; 2 push-pull on and off switches, new, in original boxes, 10d.; quantity Belling Lee terminals, A, E, LS—LS+ 2d. each; several 500 volt D.C. test 7 mfd. condensers, 4, 2, 1 mfd., 5/-; several 700 volt D.C. test 7mfd. condensers, 5/6; several 5-pin Lotus valve holders, with terminals, 10d.; several Pye 4-pin valve holders, 6d.; 2 Phillips rectifying valves, type 1801, new, original boxes, full wave, 40 mA., at 220v., 8/; 14in. 52/- loud speaker, £1/15; 4 Brownie dials, 2/6 type, new, 1/9; 2 2/6 Q.M.B. switches, 1/9; Pye L.F. transformer, latest 12/6 type, 7/6; D.P.D.T. anti-capacity switch, panel mounting, brand new, 2/-; Pilot resistogard, new, in original box, 3/-; Tungar 5 amp. charger, £3; 600 volt, 30 mA., hand generator, by Marconi, £2; 1,000 volt Evershed generator, £1/10; 50 volt D.C. 1/4h.p. motor, £1; 100 volt D.C. 1/4h.p. motor, £1; R.I. Varley straight line transformer, 12/6; Ediswan 2 amp. charger, 200v. A.C., £1/12/6; Marconi 6-valve H.F. amplifier, without case, but complete with D.E.V. valves, £2; Geocophone horn type speaker, horn slightly cracked, 10/-; brand new Garrard double spring Junior motor, unused, £1/5; new, unused Ampion pick-up, 15/-; new Kushette tone arm, 4/-; Loewe pick-up, new but with short leads, 13/-; Fultograph, complete, £5; set Colvern short wave coils and stand, new, in original box, £1/15; Brown V unit and cone, complete, 15/-; P.M. 24A valve, 15/-; except where otherwise stated, all the above are guaranteed in perfect condition; goods will be despatched immediately on receipt of cash, or will be sent c.o.d.; in the event of more than one application for the same article, cash with order will be given preference; all goods offered subject to being unsold on receipt of order.—Apply GZ, J.P., "Brooklands," Follifoot Harrogate. [9816

Components, Etc., for Sale.—Contd.

FERRANTI 50,000 Resistance, 2/6; Gambrell neutro-vernier, 2/6; D.X. dual tuner (10/-), 6/-; plug-in coils, from 6d.; Isomona S.M. dial, 1/9; 4in. Ormond dial, 1/-; Bulgin H.F. choke, 2/-; short wave, 1/9; Bebe reaction, 0.0003, 3/-; Lotus D.P.D.T. switch, 2/6; Langham portable transformer, 2/6; pair Cossor coils, 2/-.

MARCONI 15/- Phones, 7/6; bargains galore at Fifty-Four; state requirements!—Frost, 54, Clerkenwell Rd., E.C.1. [9789

FERRANTI A.F.5C, £1; Ferranti O.P.M.3, 14/-; Ferranti O.P.1, 12/6.—Kann, Brampton, Marlow. [9791

SET Ferranti Push-pull A.F.5C.C., A.F.5C, O.P.M.1C, O.P.M.4C, £3/10, used few hours only; Brown 3 1/2, 18/6; Parmeko 2-1, 25/-; Varley push-pull double ratio choke, 15/-; Nicore I, 15/-; O.P.4C, 15/-.—Bateson, 13, Rochester Sq., N.W.1. [9792

FERRANTI Volt-milliammeter, reading 7 1/2, 150 volts, 30 milli; 35/-; guaranteed perfect.—Hobley, Drive, Wellingtonborough. [9799

MATEUR Wishes Dispose Quaptily Good Components Cheaply, Ferranti transformers, variable and fixed condensers, valves, chokes, switches, leaks, resistances, coils, coilholders, rheostats, potentiometers, Regentone W2A eliminator, 6v. 40 actual accumulators.—115, Southwood Rd., New Eltham. [9800

WIRELESS Transmitting Sets for Morse Telegraphy or Distant Control of Models, etc., lin. spark coil, condensers, spark gap, helix, etc., very compact, complete and ready to use. 12/6; high quality buzzer, good note, 3/6; heavy Morse tapping key with points, 3/6.—Below.

ELECTRIC Motors, 1/6 to 1/4h.p., 110 to 220 volts D.C., silent running, carbon brushes, in perfect condition and working order, suitable for gramophones, television, or any small power uses, 10/-; a few with overheated windings, if re-wound make good dynamos for H.T. accumulators, 6/-.—Below.

COMPLETE Portable Telephone, magneto ringing, ready for use, 17/6; hand telephones, 4/6; 1,000 ohm H.F. chokes, 1/-; large earphones, 1/3; G.P.O. magnetic relays, high class instruments, 12/6; telegraphic relays, 6/6.—Below.

HIGHLY Sensitive Button Microphones, mounted in case with two terminals, all new, 2/-; watch type microphones, 2/6; breast plate microphones, with condenser and key switch, 7/6; microphone smoothing condensers, 6d.; microphone transformers, 2/6; 1in. spark coils, fully complete, 6/-; Ford ignition coils, 3/4in. spark, 4/-; 2in. spark coils, 17/6.—Below.

D.C. Electric Motors, all ball bearing and carbon brushes, 1/4 to 1/2h.p., 110 volts, 30/-; ditto, 220 volts, 50/-; 6 and 12-volt car starter motors, 10/-; 1/4h.p. Crumpton motors, 220 volts, ring oiler bearings, shunt wound, as new, 65/-; 110v. motor blower, 1/4h.p. motor, 4in. outlets, 45/-; ditto, enclosed, 2in. outlet, 40/-.—Below.

DYNAMOS, shunt wound for charging or lighting, 50 volts, 4 amps., 35/-; 100v. 3a. 45/-; 110v. 3 amp. ball bearing, 55/-; 20v. 8 amp. ball bearing, 30/-; 16v. 11a., 40/-; 100v. 10a., slow speed, £7/10; 75v., 29a., £8/10.—Below.

NEW Shunt Regulators, 100 volts to carry 10 amps., 20/-; other starters and regulators suitable for field rheostats or accumulator charging resistances, 2 amps., 7/6; 5 amps., 10/-; 8 amps., 12/6.—Below.

ALL Above Good Guaranteed; cash with order or c.o.d.; all goods 3 days' approval from date of delivery; all letters answered.—Galpin, Binfield Heath, near Henley-on-Thames. [9803

EXIDE H.T. and L.T. Trickle Charger, 75/-; 140 volt accumulator, 45/-; perfect.—Particulars, 50, Church Rd., Slaw, Oldham. [9806

BARGAINS—Tungar, 210-250v. input, 7 1/2 2a. output, valve, £2; mains transformer, input 210-250v., output 180-0-180v., 4-0v., 2.2a., 15/-; 2 D.U.10, 15/-; 2 P.M.4D.X., decapped, 10/6; J.M.14, decapped, 12/6; D.E.5A, 6/-; D.E.L.610, 5/-; Steutor Six, 5/-; all guaranteed.—Longley, Beeston, Notts. [9805

RADIO HOUSE, HUDDERSFIELD, issues the Reliability Wireless Guide, which will be sent post free upon request by Messrs. J. H. Taylor and Co., 15, Macaulay St., Huddersfield. [7823

PART Exchange.—See our advertisement under Receivers for Sale.—Scientific Development Co., 57, Guildhall St., Preston. [0228

AMAZING Bargains, amateur's surplus.—Transformers, condensers, drum dials, valves, etc., list post free; new Ferranti trickle charger, 200-240 A.C., £1/10.—Raymond Amis, 29, Maybank Rd., South Woodford, Essex. [9825

S.W. Kit Eddystone A.V. Unit, 14/6; Cyldon 0.00015 extension, 9/6; 0.0003 Formo variable, 3/6; 2 Formo S.M. dials, 3/6; lot 28/-, or exchange for B.T.H. pick-up complete.—Wild, 32, Nottingham St., Sheffield. [9907

MISCELLANEOUS.

EASY Payments.—We supply, by easy payments, components, accessories, and sets, any make; 10% down, balance spread over 11 months.—Send list of requirements to London Radio Supply Co., 11, Oct Lane, London, E.C.2. [0337

Mention of "The Wireless World," when writing to advertisers, will ensure prompt attention.

Miscellaneous.—Contd.

ALEXANDER BLACK,
THE Original Wireless Doctor, will call (London and Home Counties) and cure your set.

CONSULTATIONS by Appointment Without Obligation, sets installed, maintained, and brought up to date, gramophone pick-ups, eliminators, and Webbs moving coil speakers demonstrated; purity reproduction specialists.

55. Ebury St., Victoria, S.W.1. Sloane 1655. [0277]

SCOTT SESSIONS and Co., Great Britain's Radio doctors, officially approved as wireless repairers by Radio Society of Great Britain and Wireless League; old sets of every type repaired, rebuilt, modernised; send set for immediate quotation.

SCOTT SESSIONS and Co.—New sets constructed with your or our components, guaranteed finest workmanship; we specialise in "The Wireless World" circuits; remember, we have satisfied customers throughout the British Isles and in three Continents; if you so desire, we will design and construct high grade apparatus to suit your special circumstances for quality, range and selectivity.—Tel.: Tudor 5326. Muswell Hill, London, N.10. [0262]

ENGINEERS, novice or expert, £300, £400, £500 per year or more is within your grasp. In our handbook, Engineering Opportunities, Prof. A. M. Low explains where the good posts abound. This handbook has shown the way to better things to over 20,000 of your fellows. It contains details of A.M.I.Mech.E., A.M.I.E.E., A.M.I.C.E., A.M.I.A.E., A.M.I.Struct.E., Mairic, C. & G., G.P.O., etc., exams., outlines home study courses in all branches of electrical, mechanical, motor and wireless engineering, and shows the unique advantages of our Appointments Department. Why stay in the Hammer and File Brigade? Send for our free handbook at once, stating branch, post or exam. which interests you.—British Institute of Engineering Technology, 87, Shakespeare House, 29-31, Oxford St., London, W.1. [9726]

THE Ideal Hold-all, suitably adapted to hold screws, nuts, bolts, washers, etc., in their respective places in nine different compartments, eliminates loss of temper through loss of time; price 1/6 post free.—M. Fish and Son, Ltd. (Manufacturers), 18, Belsiam St., Homerton, E.9. Trade enquiries invited. [9801]

PATENTS.

TERMINAL, accumulator and portable receiver manufacturers; Patent No. 301,173, terminal points by rigid links, plug and/or socket connections for sale or licence, proceedings against infringement.—Patentee, E. S. Elliott, M.R.S.G.B., G5LT, 13, Merlin Way, Sheffield. [9804]

THE Owner of Complete British Patent for Wireless Apparatus for Cutting Out all Local Interference is desirous of entering into negotiations with interested parties for the disposal or working of the invention.—C. L. Edwards, 24, St. Mary's Rd., Hornsey, N.8. [9787]

PATENT AGENTS.

PATENTS and Trade Marks, British and foreign.—Gee and Co. (H. T. P. Gee, Member R.S.G.B. and A.M.I.E.E.), 51-52, Chancery Lane, London, W.C.2. Phone: Holborn 1525. [0001]

KING'S PATENT AGENCY, Ltd., 146a, Queen Victoria St., E.C.4.—Free advice and handbook on patenting inventions and registering trade marks by registered agent with 43 years' experience. [0002]

REPAIRS.

SCOTT SESSIONS and Co., Great Britain's radio doctors; read advertisement under Miscellaneous column. [0263]

REPAIRS Returned Post Free, and to ensure satisfaction send remittance after approval of same.—Leeds Wireless Repair Service.

LOUD-SPEAKERS, headphones, rewound to any resistance and remagnetised, 3/-; transformers rewound, 4/-; Blue Spot, Triotrons and 4-pole units, 4/6; work guaranteed.—Leeds Wireless Repair Service, 5, Boston Place, Green Rd., Leeds. [9659]

THE BARNES RADIO SERVICE.—Repairs, rebuilding, demonstrations, radio gramophones and scratch filters; reproduction specialists; any distance.—53, High St., Barnes, S.W.13. Prospect 5633. [9705]

GUARANTEED Repairs by Experts.—Loud-speakers, headphones, cone units, pick-ups, any type, rewound, remagnetised, and adjusted post free 4/-; transformers, from 4/-.—Howell, 91, Morley Hill, Enfield, Middlesex. [9555]

WANTED.

ALL Types of Electrical and Wireless Apparatus Purchased for Cash; large quantities only.—T. W. Thompson and Co., 17, Strutton Ground, S.W.1. [0331]

WANTED, 6-volt accumulator, 100 amp. hours.—R. Loker, 8, Suffolk Terrace, West Thurrock, Essex. [9775]

EXPONENTIAL Horn, large; send dimensions, price, style and material; deposit system.—Norton, High St., Porlock, Somerset. [9782]

Why not dance to Radio Paris, Toulouse and Hilversum Music?

With the "Supremus" All Electric 2-Valve Receiver it is the simplest matter. So simple that even a child can operate it. You should hear it. Long and short wave stations can be obtained by the mere operation of a switch. This set is equal to any 3-valve battery operated receiver. London listeners have been specially catered for and stations can be parted easily. There is a 12 months' guarantee with each set.

PRICE £12 : 0 : 0.

Using a "Supremus" All Electric 2-Valve Receiver a Birmingham amateur picked up 18 stations full speaker strength at first attempt.

"SUPREMUS" 2-VALVE ALL ELECTRIC

SUPREMUS SPECIALITIES Ltd., 118, HIGH ST., ERDINGTON, BIRMINGHAM. Northern Agents: THE CHORLTON METAL CO., 18, Amber Street, Manchester. London Agent: P. H. SMEDLEY, 50, Richmond Road, Leytonstone, E.11.

SEND TO-DAY FOR OUR FREE 36-PAGE BOOKLET "SOUND ADVICE."



The Finest High-grade Speaker in the World

PERFECT RECEPTION FOR MUSIC LOVERS

BAKER'S 'selhurst' RADIO

Offices: 89, Selhurst Rd., S. Norwood, S.E.25. Works: 42, Cherry Orchard Rd., E. Croydon.

Super Power Moving Coil Speaker.

THE DIX-ONEMETER

It has Two Clear Scales with Mirror for Accurate Reading; only 8 Terminals, but 50 Ranges.

NOW ONLY 50/-

A remarkably low price for a meter worth £10

For Novice or Expert. Test Booklet Free.



LIST OF RADIO BARGAINS OF EVERY TYPE ON APPLICATION

ELECTRADIX RADIOS

218, Upper Thames St., London, E.C.4. Telc.: City 1091

EXCHANGE.

RADIO Part Exchange.—Particulars of the first and largest service in existence will be forwarded upon request to The Secretary, Appleby's, Chapel St., Marylebone, London. [0339]

EXPERIMENTER Wishes Exchange New 84v. or P.M.24A for 1020, L.S.5A, or L.S.6.—Box 6478, c/o The Wireless World. [9766]

3A Pocket Folding Kodak (postcard) Goerz aluminium lens box, 1/6.8. Compur shutter, bulb release, shutter times 1/4 to 150th sec.; wanted, portable gramophone or Amphon Lion chassis.—J. T. Harding, Wynngate Terrace, Wingate, Co. Durham. [9768]

PAIR of Standard Four L.W. Coils; £1, or exchange for Hypermu transformer.—A. Gorton, 16, Crescent, Will. [9769]

WE will Accept Your Surplus Apparatus (making you a high allowance) in Part Payment for Any New Apparatus; your enquiry will be dealt with promptly.—Bostock and Stonhill, 1, Westbourne Terrace, S.E.23. [9778]

BUSINESSES & PROPERTY FOR SALE, TO BE LET, OR WANTED.

WIRELESS Manufacturing Business for Sale, registered trade name, factory London district, Principals only.—Box 6533, c/o The Wireless World. [9814]

SITUATIONS VACANT.

WIRELESS Operating; fees payable after appointment; amateur Morse classes.—Manager, Wireless School, 21, Manor Gardens, London, N.7. [9378]

WIRELESS Services.—The premier telegraph college in the British Isles (established 34 years) gives a sound training to all students, with assured positions on qualification; fees are not disguised under expensive board-residence scheme, but are payable by easy instalments, if desired.—Apply for Prospectus, Dept. "W.W." The London Telegraph Training College, Ltd., Morse House, Earl's Court, S.W.5. [9615]

ASSISTANT Required, S.E. London, radio and electrical, real knowledge radio, neat constructor; experience electrical trade advantage.—Write age, wages required, experience, to BM/XRY6. [9779]

SITUATIONS WANTED.

MAN, 24, seeks situation, good knowledge L.F. amplifiers; accept small wage start.—Box 6534, c/o The Wireless World. [9815]

YOUNG Man, 21 years, seeks post as service man, experienced in portables, all mains sets, and radio gramophones.—Box 6532, c/o The Wireless World. [9818]

TEST Engineer, radio and gramophones, with extensive mains experience, excellent references, London area.—Box 6529, The Wireless World. [9810]

KEEN Amateur Since 1919 Wants Enter Radio Trade, good all round knowledge theory and practice, had mechanical and shop experience, age 30.—Cooper, 2, Chequers Way, Palmers Green, N.13. [9793]

BOOKS, INSTRUCTION, ETC.

FREE: Inventor's Guide on Patents.—T. A. A., 253, (W), Gray's Inn Rd., London, W.C.1. [6373]

TELEVISION.—The complete authorised book on television (Baird Experimental) transmission and receiving is now ready; order "Television To-day and To-morrow" (Moseley and Barton Chapple), 7/6 net.—Pitman's, Parker St., Kingsway, W.C.2. [9309]

STEP by Step Wireless.—A complete course of instruction for wireless engineers; send 1/- for first 4 weeks.—Clifford Pressland, A.M.I.E.E., Hampton-on-Thames. [0195]

BONA FIDE TRADERS' GUIDE.

Send for our comprehensive Illustrated List. **QUICK SERVICE. QUICK SERVICE.**

THE QUALITY HOUSE.

PERSEUS MFG. CO., LTD. (Dept. W.W.), BRANSTONE RD., BURTON-ON-TRENT

LINE TRANSFORMERS.

100/110v. input, 200/240v. output for 40/100 Cycle Mains **36/-**

To deliver up to 60 watts.

R. & B. LINE AUTO TRANSFORMERS can be supplied to step up or down for any voltage, periodicity and output.

Send your enquiries to:—

RICH & BUNDY LTD., 13, New Road, Ponders End. Phone: ENFIELD 0777.

INDEX TO ADVERTISEMENTS.

	PAGE		PAGE		PAGE
Abbey Radio	Cover ii.	Gambrell Radio, Ltd.		Rich & Bundy, Ltd.	13
Adolph, Friedk.	11	Garnett Whiteley & Co., Ltd.		Rigby & Woolfenden	13
Aetolian Co., Ltd.	10	General Electric Co., Ltd.	1	Rothermel Corporation, Ltd. (Centralab)	14
Apollo Gramophone Co., Ltd.		Hegra		Rowley, Thomas A., Ltd.	
Appleby, E. Hetherington	10	Heizman, L.		Scientific Supply Stores	
Baker's "Selhurst" Radio	13	Hughes, F. A. & Co., Ltd.	2 & 3	Sheffield Magnet Co.	
Bayliss, William, Ltd.	Cover iii.	Impex Electrical, Ltd.	14	Sherwood, A. M. E.	10
Belling & Lee, Ltd.		Jackson Bros.		Standard Telephones & Electric Co., Ltd.	
Burne-Jones & Co., Ltd. (Magnum)		Lectro Linx, Ltd.		Supremus Specialities, Ltd.	13
Burton C. F. & H.	Cover i.	Lever, Eric J. (Trix), Ltd.		Telsen Electric Co., Ltd.	Cover i.
Carrington Manf. Co., Ltd.		Lock, W. & T., Ltd.		Thomas, Bertram	5
Cole, E. K., Ltd.		London Radio Supply Co.		Transformer Repair Co.	10
Donotone		Lustrulux, Ltd.	7	Tungsram Electric Lamp Works (Great Britain), Ltd.	Cover i.
Dubilier Condenser Co. (1925), Ltd.	Cover ii.	Lyons, Claude, Ltd.	Cover i.	Ultra Electric, Ltd.	
Eastick, J. J. & Sons		McMichael, L., Ltd.		Vandervell, C. A. & Co., Ltd.	
Edison Swan Electric Co., Ltd.		M.L. Magneto Synd., Ltd.	8	Varley (Oliver Pell Control, Ltd.)	5
Electradix Radios	13	Moore & Co.		Westinghouse Brake & Saxby Signal Co., Ltd.	8
Epoch Radio Manf. Co., Ltd.		Mullard Wireless Service Co., Ltd.	Cover iv.	Weston Electrical Instrument Co., Ltd.	7
Ever Ready Co. (G.B.), Ltd.		Persus Manf. Co., Ltd.	13	Wilkins & Wright, Ltd.	
Exide	9	Philips Radio		Wingrove & Rogers, Ltd.	10
Ferranti, Ltd.	9	Radiogramophone Development Co.	7	Yates, Sutton, Ltd.	11
Formo Co.		Regent Radio Supply Co.			



It would be
FATAL
to lose
CONTROL

Barbed wire—trenches—dug-outs—a field set and a thin strand of wire.

The difference between control and lack of control may spell life or death to an entire brigade.

It's a far cry from No Man's Land to the comforts of your home.

But even in your radio set . . . control plays a vital part . . . and it has been the privilege of CENTRALAB to furnish the volume controls of millions of radio receivers.

Is your radio—CENTRALAB equipped?



Write for free Booklet, "Volume Controls, Voltage Controls, their uses."

Centralab

THE ROTHERMEL CORPORATION LTD.,
24, Maddox Street, London, W.1.

Phone: MAYFAIR 0578/9.

Continental Sales Office:
27, QUAI DU COMMERCE, BRUSSELS, BELGIUM.

Amazingly low prices are selling these Dario Valves in tens of thousands!

The best Screen-Grid in the world.
Bivolt .15 amps. Forvolt .075 amps.

SCREENODION 15'6

DARIO L.F. TRANSFORMER
A little marvel. Guaranteed for two years. Completely shrouded. Perfectly designed and perfectly made.
5-1 or 3-1 **5-**

SUPER HF 5'6
Bivolt .15 amps
Forvolt .075 amps

Super DETECTOR 6'6
A super-sensitive detector for anode-bend or leaky-grid rectification.

UNIVERSAL RESISTRON 5'6
SUPER POWER 7'6
and the Super Power **PENTODION 18'6**

HYPER-POWER
Bivolt .3 amps
Forvolt .15 amps
9'6

Write for Free Folder to:—
IMPEX ELECTRICAL, LTD.,
Dept. C, 538 High Road,
Leytonstone,
London, E.11

DARIO VALVES

Best way to all Stations

175

THE MOTOR CYCLE
The Motor Cyclist's Newspaper
EVERY THURSDAY — 3d.
Publishers: ILIFFE & SONS LTD., Dorset House,
Tudor Street, London, E.C.4. w.w.15

The Autocar
The Leading Motoring Paper
EVERY FRIDAY, 4d. w.w.16.

EXPERIMENTAL WIRELESS
& The WIRELESS ENGINEER

The Journal of
Radio Research and Progress

Monthly 2s. 6d. net. w.w.2

TUNING COILS
and METHODS of TUNING

By W. James. (1925)

Price 2/6 net. By post 2/10.

From ILIFFE & SONS LTD.,
Dorset House, Tudor Street, London, E.C.4,
and leading booksellers. w.w.32

Mention of "The Wireless World," when writing to advertisers, will ensure prompt attention.

BAYLISS

Superior Quality Power Transformers
and Chokes for the Mains from 35/- each
—to Customers' Requirements.

BAYLISS ROTARY CONVERTERS

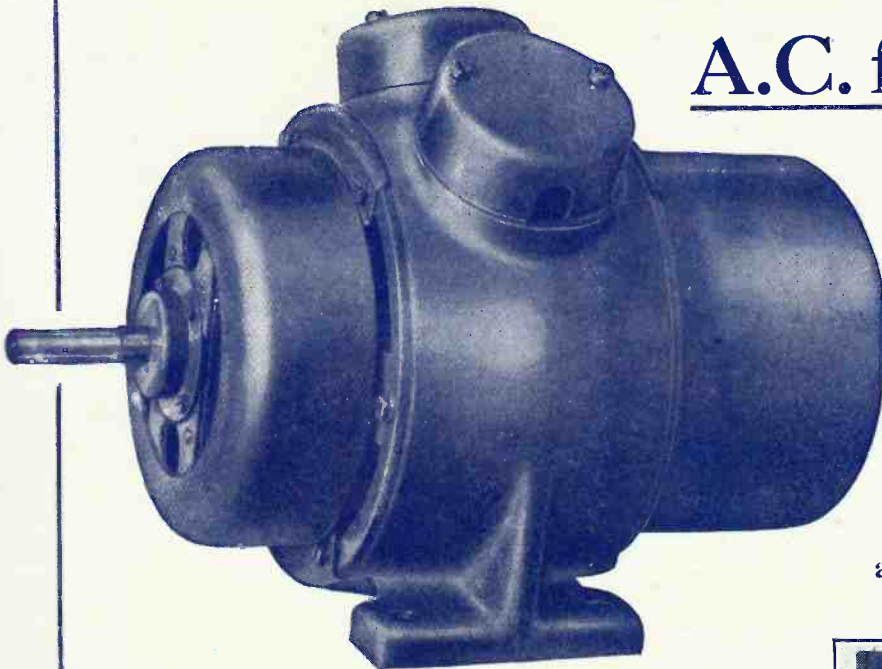

A.C. from D.C.

ANY Input.
ANY Output.

Loads up to
400 Watts.

PRICE

£12 . 10 . 0

For Audio
Amplifiers
and General Purposes.

Also Dynamos,
Motor Generators, etc.
for all purposes.

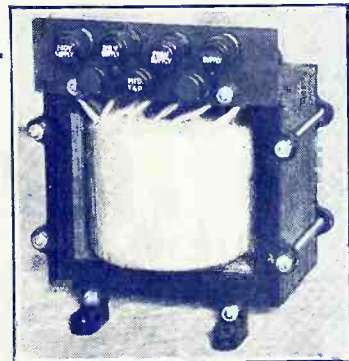

WILLIAM BAYLISS LTD.

Contractors to the Admiralty, War Office, Colonial Governments, etc.

Sheepcote Street

BIRMINGHAM

Telephone :
Mid. 1499.

Telegrams :
"Drawbench, B'ham."

PLAIN FACTS ABOUT THE SCREENED GRID

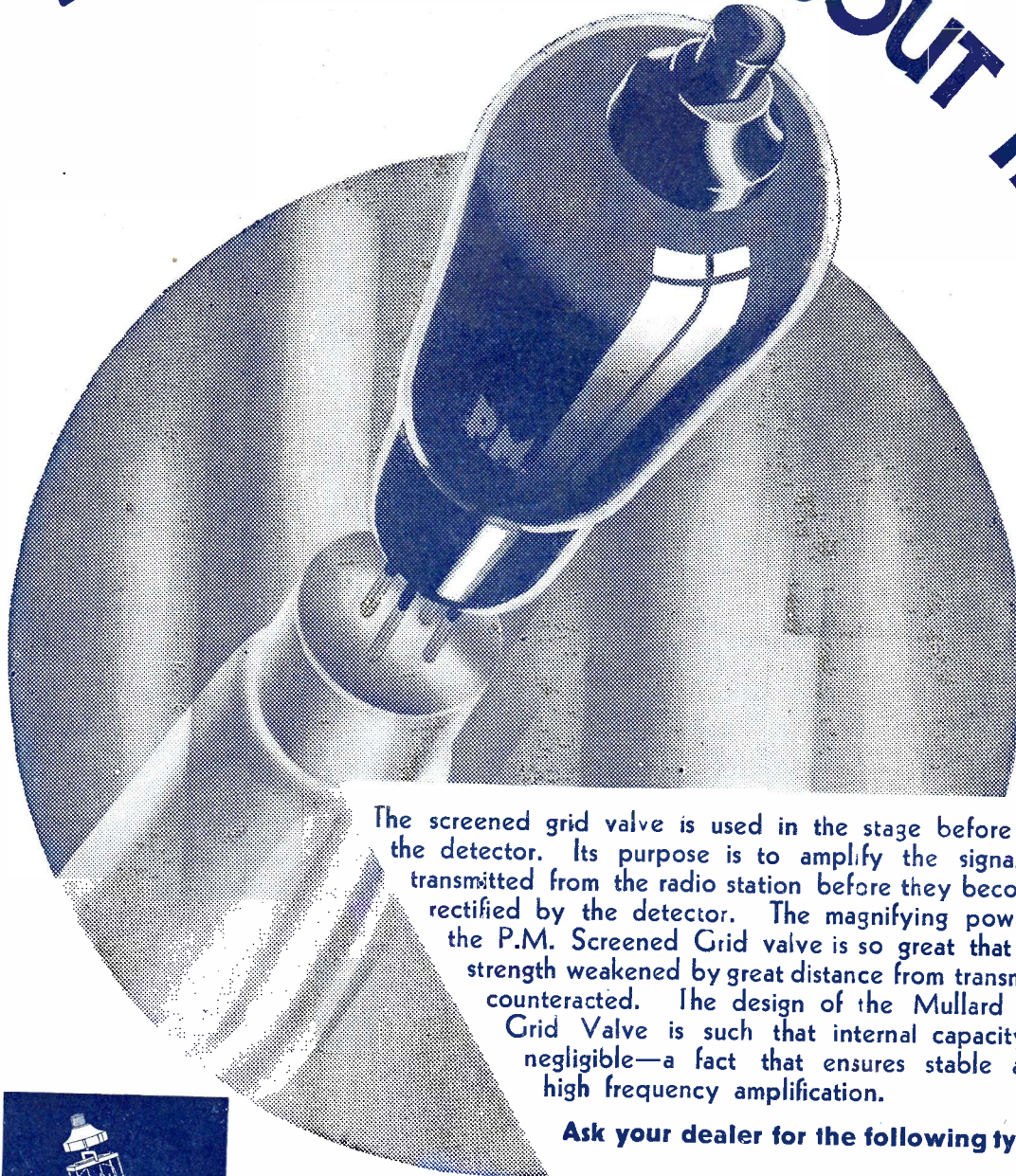

The screened grid valve is used in the stage before the detector. Its purpose is to amplify the signals transmitted from the radio station before they become rectified by the detector. The magnifying power of the P.M. Screened Grid valve is so great that signal strength weakened by great distance from transmitters is counteracted. The design of the Mullard Screened Grid Valve is such that internal capacity is almost negligible—a fact that ensures stable and efficient high frequency amplification.

Ask your dealer for the following type numbers—

2 volt
P.M. 12

4 volt
P.M. 14

6 volt
P.M. 16



Above: An illustration showing the filament inside a Mullard Screened Grid Valve. The thin thread-like filament represents the result of continuous and concentrated experiment in the Mullard Laboratories.

Mullard

THE · MASTER · VALVE

Advt. The Mullard Wireless Service Co., Ltd., Mullard House, Charing Cross Road, London, W.C.2.

ARKS.

Printed for the Publishers, ILIFFE & SONS LTD., Dorset House, Tudor Street, London, E.C.4, by The Cornwall Press Ltd., Paris Garden, Stamford Street, London, S.E.1.

Colonial and Foreign Agents:
 UNITED STATES—The International News Co., 131, Varick Street, New York. FRANCE—W. H. Smith & Son, 248, Rue Rivoli, Paris; Hachette et Cie, Rue Béaumont, Paris.
 BELGIUM—W. H. Smith & Son, 78, Marche aux Herbes, Brussels. INDIA—A. H. Wheeler & Co., Bombay, Allahabad and Calcutta. SOUTH AFRICA—Central News Agency, Ltd.
 AUSTRALIA—Gordon & Gotch, Ltd., Melbourne (Victoria), Sydney (N.S.W.), Brisbane (Queensland), Adelaide (S.A.), Perth (W.A.), and Launceston (Tasmania).
 CANADA—The American News Co., Ltd., Toronto, Winnipeg, Vancouver, Montreal, Ottawa, St. John, Halifax, Hamilton; Gordon & Gotch, Ltd., Toronto; Imperial News Co., Toronto, Montreal, Winnipeg, Vancouver, Victoria. NEW ZEALAND—Gordon & Gotch, Ltd., Wellington, Auckland, Christchurch and Dunedin.